

RC10LS

with

DYNAMIC STRUT FRONT SUSPENSION

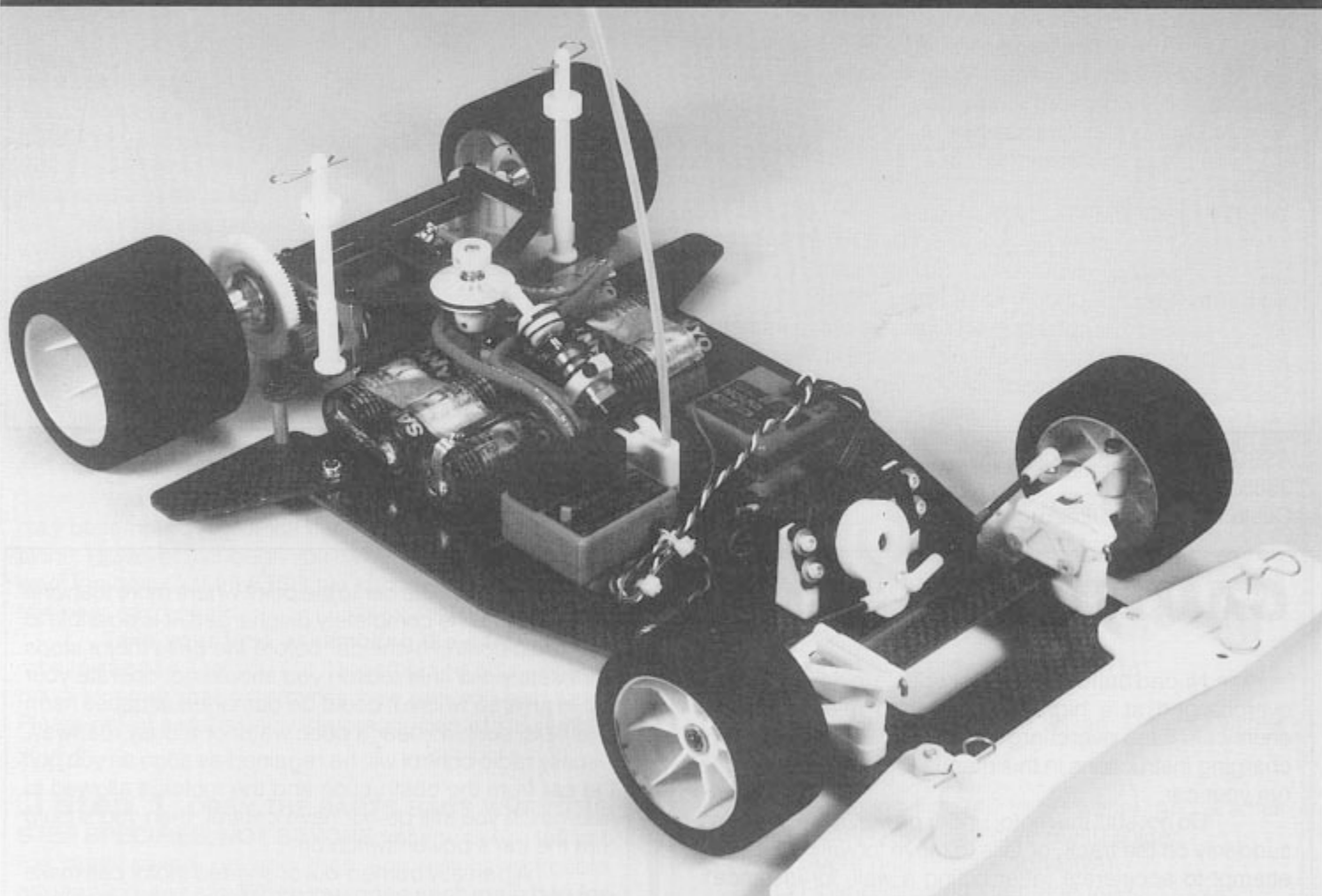

1:10 scale Road Racing R/C Car Kit

INSTRUCTION MANUAL

RC10LS GRAPHITE with Dynamic Strut

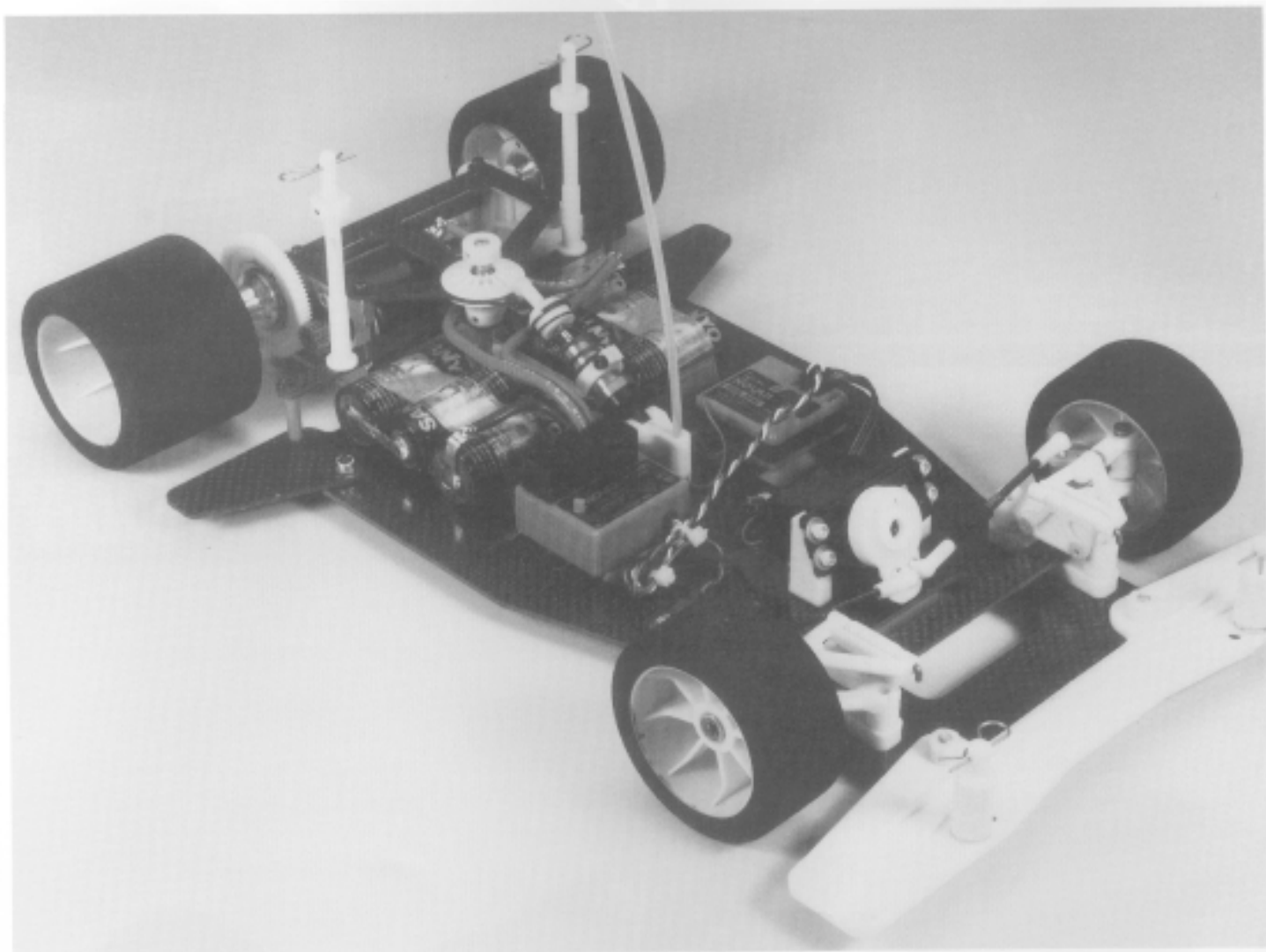

ASSOCIATED ELECTRICS, INC.
3585 Cadillac Ave.
Costa Mesa, CA 92626

AE TEAM ASSOCIATED
©1993 ASSOCIATED ELECTRICS, INC.

CAUTION

Ni-cad batteries are susceptible to damage when overcharged at a high rate, and can release caustic chemicals if the overcharge is severe. Read the battery charging instructions in this manual before attempting to run your car.

Do not stall the motor under power. If the car stops suddenly on the track, or fails to move forward when you attempt to accelerate (after hitting a wall, for instance), push the throttle control on your transmitter to the brake position immediately and attend to the car. A small rock or other piece of debris may have stalled the gears, and if the throttle is left in the "ON" position, the result can be a burned-out motor, resistor or electronic speed control unit.

If you run the car to the point where more than one cell in the pack is completely discharged, it is possible to lose radio control of the car before the drive motor stops completely. For this reason you should not operate your car in an area where it could be damaged or cause harm to others, such as near a pool, water or a busy roadway. Usually radio control will be regained as soon as you pull the car from the obstruction and the motor is allowed to free-run. If you still do not have control, then you should turn the car's power switch off.

A partially burned-out or shorted motor can make the car appear to have radio problems. If the car slows down suddenly and the radio acts erratically even with a full battery charge, then the cause is probably the motor. Check the range of the radio. A shorted motor will draw extremely high current even under no-load (free spinning) conditions.

FIRST, A WORD

CONGRATULATIONS! You now have the winningest 1/10 scale on-road car in the world! The original RC10L design came from our World Championship-winning RC12L car. We initially built one RC10L prototype car for the 1988 ROAR Nationals—where it took Top Qualifier honors. We then built nine more prototypes for the rest of the Team Associated drivers to run at the ROAR Regionals. With 160 entries, the RC10L took Top Qualifier honors in both classes, won both classes, and placed eight cars in the Stock A-Main and seven cars in the Modified A-Main. At its third race ever, at the old Los Angeles Velodrome in 1988, it set a new national top speed record for 1/10 cars at 56.5 mph! Since then, the original RC10L has won the ROAR On-Road Nationals four years in a row, from 1989 through 1992.

Now we have improved this winning design with the introduction of the RC10LS. Those of you who have already raced the RC10L will notice only a couple of major changes to the car. While the number of changes are small, the results are not. The biggest change is the switch to our new Dynamic Strut front suspension. This front end improves the steering and handling of the car. It gives you the ability to make adjustments much easier and quicker. This means you can try different settings in less time than before: you will have more time to attempt new combinations to fine tune the car. We have also switched over to our new, improved style shock with the new Teflon assembly parts and Teflon shock pistons for better shock action. Lastly, we have added a rear chassis brace to improve the rigidity of the back of the car.

BEFORE YOU BEGIN

You will find the photos so easy to follow that you may be tempted to put the car together from the photos alone. However, although you have the best car kit, if you want the best COMPLETED car kit, then please read the text near each photo.

Take your time assembling the car. It's not a race to see how fast you put it together; it's how well you put it together that determines how fast you can race. Please note the steps below *before* you begin to assemble your kit.

Step 1 OPEN THE PARTS BAGS WHEN THE STEP SPECIFIES, NOT BEFORE, otherwise you will get the parts mixed up and then you will have trouble assembling your car. **When you open each main bag for the first time, check the contents against the parts list** supplied as a separate sheet that came with your manual.

All major parts bags are referred to by number in the manual. While building the car, you will sometimes be working with several bags at the same time. These bags

are referred to by bag number in the manual. Inside each major parts bags there are more bags; these are not numbered and belong to the bag they came out of.

Step 2 KEEP THE PARTS SEPARATE. While building the car, you will sometimes be working with several parts bags at the same time. Bags and parts will start multiplying like rabbits as you build. Try not to confuse one bag with another. A good way to prevent this is to use **large paper plates with partitions.** They are ideal for both keeping parts separate and spreading them out where you can find them. Mark the plates with the bag numbers before you put the parts into them. When the plates are used up you can relabel the plate for another bag. (We include some miscellaneous spare fasteners and clips, so do not worry when you have parts remaining after you have finished.)

Step 3 CHECK THE SUPPLEMENTARY SHEETS. Associated is constantly testing new and improved components and then updating the kit with the best. Not all updates will be noted in the written manual (the manuals cannot be reprinted to keep up with the updates). So before you begin, check each parts bag to see if they contain any supplementary instruction sheets. If so, locate the section of the manual where this change first applies and attach the sheet(s) to that section, then you will not forget about the changes when assembling the kit.

Step 4 ADDITIONAL ITEMS NEEDED TO COMPLETE THE KIT:

- 2-channel R/C surface radio system.
- Battery pack (6 or 7 cell), capable of being assembled into a saddle pack design.
- Battery charger (for 6 and/or 7 cell packs).
- Electronic Speed Control.
- R/C electric motor.
- Motor pinion gear (48 pitch); size will be determined by type and wind of motor being used.
- 1/10 scale on-road body and wing.

Step 5 TOOLS: Your kit contains the three Allen wrenches and the turnbuckle/shock wrench that you will need to assemble your car kit, but you will still need the following tools:

- #2 Phillips screwdriver (#SP-76)
- Needle nose pliers
- A hobby knife, such as an X-acto® with a pointed blade
- Small file
- Soldering iron (40 to 50 watts), and a small amount of ROSIN (not acid) core 60/40 solder.
- Super glue (instant adhesive)
- Fiber-reinforced strapping tape
- Electrical tape

The kit can be assembled faster and easier with the following tools:

- Screwdriver-handle Allen wrenches in the

following sizes:

- #6957 .050"
- #6958 1/16"
- #6960 3/32"
- #6961 2.5mm

A 3/16" nut driver will make installing the ball ends and upper arm turnbuckles easier. (#SP-86)

A 1/4" nut driver will make installing the 4-40 nuts easier. (#SP-85)

A 11/32" nut driver will make installing and adjusting the 8-32 rear axle diff nut easier. (#SP-82)

A precision ruler with decimal inches or metric measure.

WARNING! Do not use a power screwdriver to install screws into nylon parts. The rotation speed is too fast, and will cause the screws to heat up when they are driven into plastic or nylon parts, and they will strip out.

Step 6 DO NOT DYE YOUR PARTS. Normally, because our parts are made of virgin nylon, you could dye the parts. But because of the very tight tolerances of the new front end, we DO NOT recommend dyeing or boiling these parts. Dyeing or boiling causes swelling of the parts, which will jam the new front end parts and compromise its performance.

Step 7 FINAL NOTES:

(1) For you experienced builders and racers: **please build the car our way first!** The RC10LS is a remarkably fast car right out of the box. There is a good reason for everything on the car, and very few compromises were made in its design. Build it our way first and see how it handles before you make any changes.

(2) Put a check mark (✓) in the box (☐) at each step after you finish it. When you stop during assembly, it will be easier to find where you left off.

(3) To help you identify certain parts, occasionally an actual-size drawing will accompany the steps. You can place your part on top of the drawing to be sure you have picked up the right one.

(4) In some places in the instructions we have provided numbers in parentheses within the text to present an easier-to-follow, step-by-step assembly.

(5) We have used abbreviations throughout this manual for the various types of screws used. The following list identifies what the abbreviations stand for:

FHMScrew: Flat Head Machine Screw. Use #2 Phillips screwdriver.

FHSScrew: Flat Head Socket Screw. Use Allen wrench or driver.

BHSScrew: Button Head Socket Screw. Use Allen wrench or driver.

SHCScrew: Socket Head Cap Screw. Use Allen wrench or driver.

(6) The following types of notes, *in italics*, will be used throughout the manual:

Racer's Tip: *This is a trick used by some of the Team Drivers to improve their car's handling or to reduce its maintenance.*

Note: *Alternate ways to assemble the kit, including tips for smoothing out the difficult assemblies.*

WARNING! *This alerts you to be careful during this step to prevent harm to yourself, reduced performance, or damage to the parts due to use of wrong parts.*

SAVE THIS MANUAL! This is more than an instruction manual. It is also a handy supplement to the Team Associated 1/10 scale on-road catalog. You can use the manual photos to help you identify part numbers and names when ordering parts.

Now clear off your workbench, line up some paper plates, grab a drink and a sandwich, and let's begin!

CHASSIS PREP

Figs. 1 & 2 The new RC10LS is offered only in a graphite chassis version. The chassis is the same as the one used in our #8002 RC10L graphite, and the same configuration as the fiberglass chassis used in our #8001 kit. At the time of release, all the parts from this car will also fit onto our original RC10L, and vice-versa

To begin, remove your #8176 graphite chassis from the kit box (fig. 1). You will notice that one side of the chassis (the bottom) has the holes countersunk for the screw heads. On the other side of the chassis (the top) we will want to file, at a slight angle, both sides of the six slots that are toward the rear of the chassis (or seven slots, if you are using 7 cell packs). Filing these sharp edges prevents them from cutting through the battery sleeves. For the same reason, lightly file the top and bottom of the chassis where the strapping tape (that holds the batteries) will touch the chassis edges, then they will not cut the tape. Now dip a piece of #280 or #320 grit wet or dry sandpaper in water and smooth all the edges of the chassis.

WARNING! *Graphite dust can be harmful to your health, so make sure that you do the work in a well ventilated location and take proper safety precautions. When you have finished, wash off the chassis with running water and dry it with paper towels. Wash your hands off*

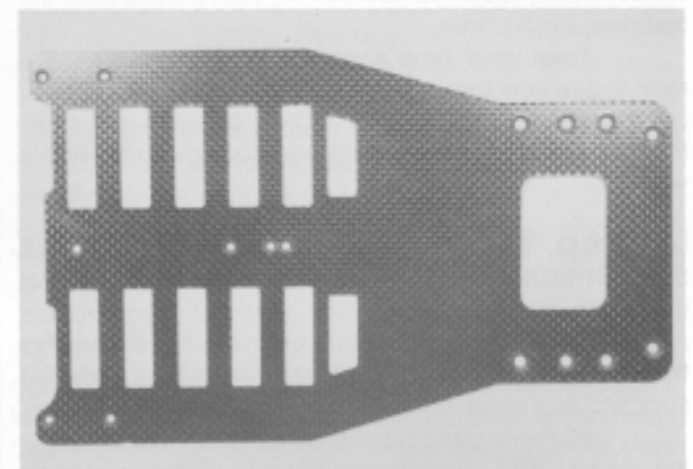

Fig. 1

with soap and cold water to remove any graphite dust. Carefully dispose of the graphite filings or dust.

You are now finished with figs. 1 & 2 so put a check mark in the box at the top of this step. After you have completed each step from now on, check off its box so you know which part of the assembly is completed. You will not miss any steps this way.

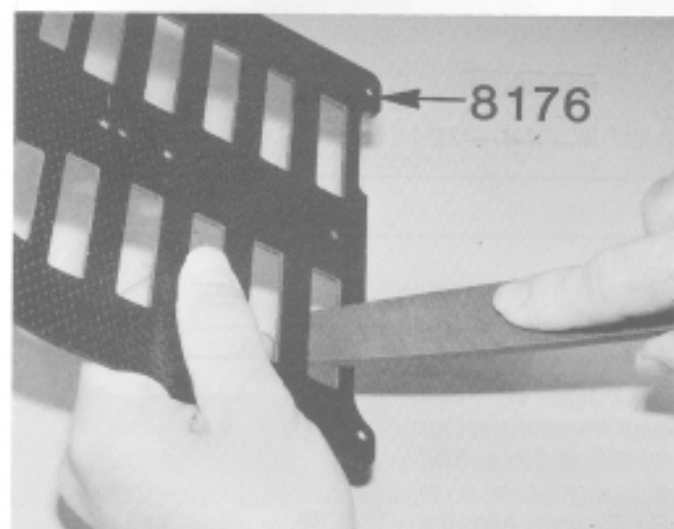

Fig. 2

Fig. 3 **WARNING!** We highly recommend doing this step for safety, but it can be considered an optional procedure. It's to help prevent shorting of the battery cells against the chassis.

Because graphite conducts electricity somewhat like metal we have to take some of the same precautions that we would with metal. Because of its conductivity we must insulate the battery cells so that they cannot short out on the chassis. The shrink wrap on the battery cells is an insulator, and we have filed the sharp edges off of the chassis so they will not cut through the cell shrink wrap, but we should go one step further. We must wrap all eight battery slots with electrical tape where the batteries will touch. **Note:** It is also important to make sure that none of the battery cell solder connections can touch the chassis anywhere, either.

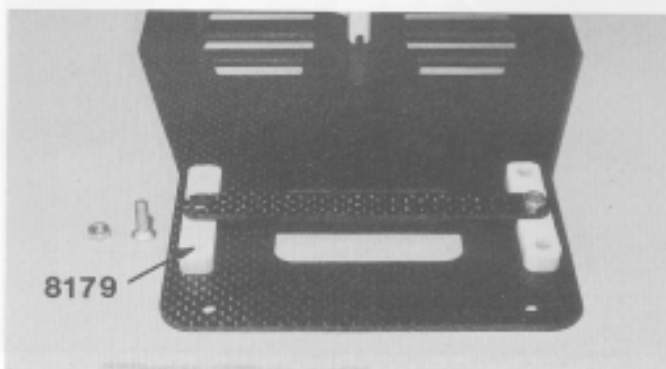

Fig. 3

DYNAMIC STRUT FRONT END

Fig. 4 In bag 2 you will find two #8179 front suspension arm spacers and two #3324 8-32 x 1/2" FHMScrews. The suspension arm spacer has one side where the holes are slightly countersunk (chamfered). Mount this side against the chassis and then thread the 1/2" FHMScrew through the center hole of the chassis from the bottom and into the center hole of the spacer block. Make sure all three holes in the spacer line up with the three holes in the chassis. If they do not, then rotate the suspension block around and line them up.

Go back to bag 2 and remove the #8178 front chassis brace and two #8182 8-32 aluminum plain nuts. Install the chassis brace over the two 8-32 aluminum screws and then thread on the two plain nuts. Align the three holes on each spacer and tighten the plain nuts.



#8182
8-32 plain nut
aluminum

#3324
8-32 x 1/2
aluminum

Fig. 4

Figs. 5 & 6 Again from bag 2, the front end bag, remove the #8407 front upper arm mounts (see photo). The photo shows two different types of upper arm mounts as well as both left and right mounts. Notice that one side of each mount has two "domes" with holes drilled through the middle (see fig. 5). Lay out your upper arm mounts as shown in fig. 5 with the "domes" facing down.

Now locate the right side 10° mount (as shown in photo) and remove it from the parts tree.

From bag 2 remove the #8419 right lower suspension arm and two #8409 4-40 x 1/2" aluminum FHSScrews. (To make sure you have the correct lower suspension arm, place the lower suspension arm in front of you with the ball socket hole to the right. The arm mounting hole which has the slanted (or angled) top surface will be the rear or back mounting hole.) In the master bag you will find the #6950 Allen wrench tool bag. This bag contains one each 3/32", 1/16" and .050" Allen wrenches. Take the 1/16" Allen wrench to start with. (**Note:**

Associated #6958 screwdriver handle Allen wrench would work well here). Using the two aluminum screws and the 1/16" Allen wrench, screw the 10° right hand upper arm mount to the lower suspension arm. Make sure the "domes" of the upper arm mount fit into the spaces in the lower suspension arm. Also make sure the upper arm mount is slanting down and forward when mounted. Now repeat figs. 5 & 6 for the left side.

Note: If you are going to be running flat oval with your RC10LS, then you will want to use the 0° upper arm mounts instead of the 10° upper arm mounts.

left side ↓ 10° mount right side ↓ 10° mount

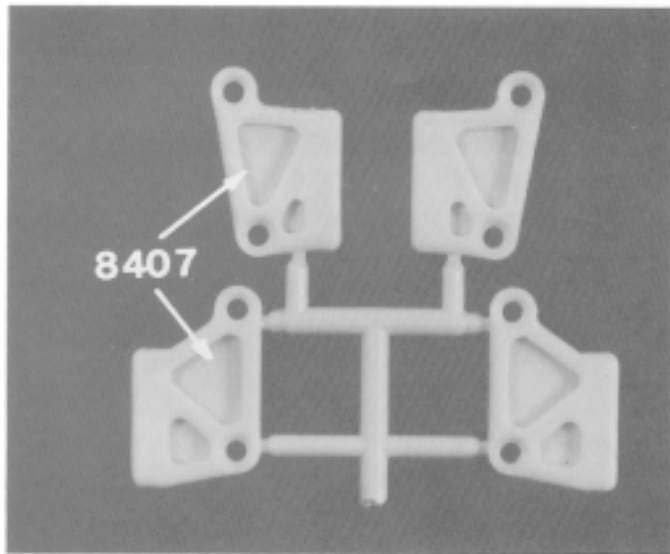

↑ right side 0° mount Fig. 5 left side ↑ 0° mount

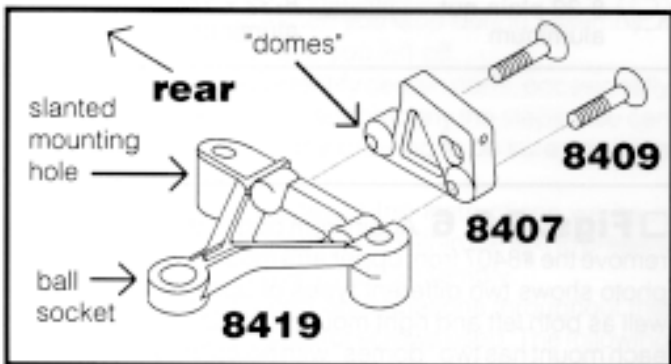

#8409
4-40 x 1/2
aluminum

(NOT ACTUAL SIZE.)

Fig. 6

Fig. 7 From bag 2 locate the small bag containing the four #8417 plastic pivot balls. Take two of the pivot balls and install one into each front lower suspension arm. To install the pivot ball, place the ball on a flat surface with the shoulder up, and then snap the #8419 lower suspension arm onto the ball with your thumb, as shown. Do the same for the other suspension arm. **Note:** Always install the pivot balls from the bottom of the lower arms. **WARNING!** Do not use pliers to install the plastic pivot balls.

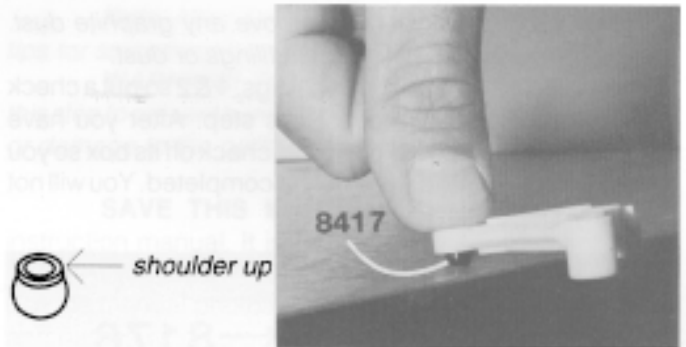

(NOT ACTUAL SIZE.)

Fig. 7

Fig. 8 From bag 2 remove the four #8439 8-32 x 5/8" aluminum FHMScrews. Align the right lower suspension arm over the two unused mounting holes of the suspension arm spacer. Thread two aluminum screws into the spacer and lower suspension arms from the bottom of the chassis. Now install the left suspension arm. Make sure the lower suspension arm mounting hole with the beveled top side is to the back of the car chassis.

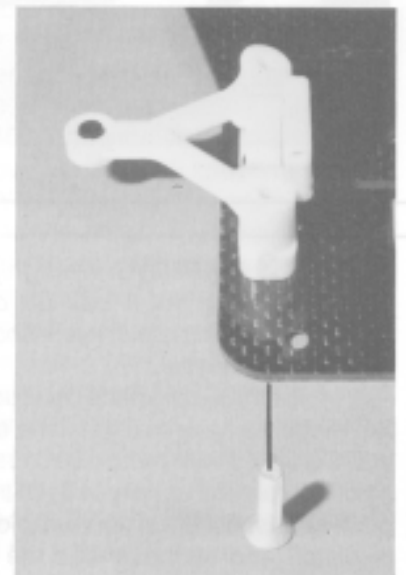

Fig. 8

#8439
8-32 x 5/8
aluminum

Fig. 9 In bag 2 you will find two #8411 nylon eyelets, two #8415 upper arm turnbuckles, and two #8405 upper suspension arms. From the same bag remove the #8416 turnbuckle/shock wrench (gold colored). Now screw one of the #8415 turnbuckles into each upper suspension arm until the threads bottom out. **Note:** A 3/16" nutdriver will help speed up this step (Associated #SP-86). Now holding the turnbuckle center nut with your #8416 turnbuckle wrench, thread a nylon eyelet onto each turnbuckle until the threads bottom out.

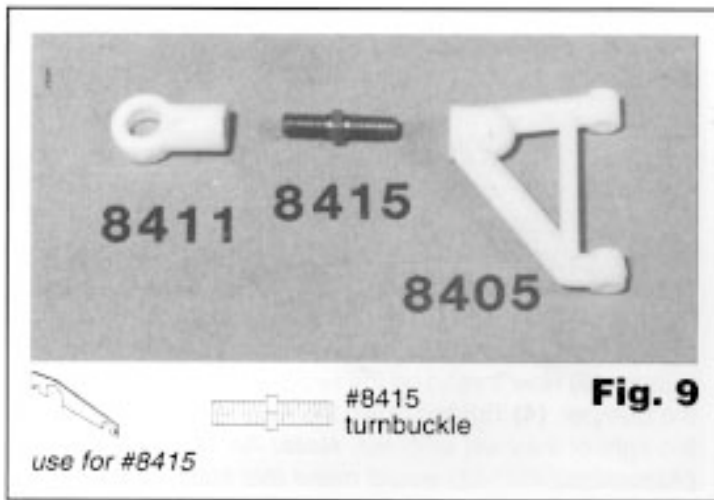

Fig. 9

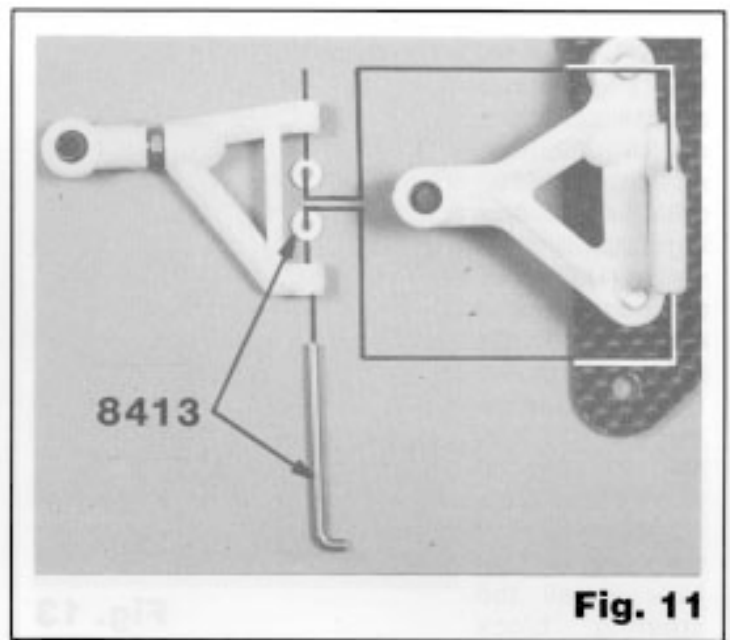

Fig. 11

Fig. 10 Go back and get the two remaining #8417 plastic pivot balls that we pulled out of bag 2 in fig. 7. Place one of the balls on a flat surface with the shoulder down. Now snap the eyelet onto the plastic pivot ball. Go ahead and install the other pivot ball into the other upper arm assembly. **WARNING!** Make sure that the ball is always installed from the side of the eyelet with the square (not rounded) edges. Do not use pliers to install the pivot balls.



shoulder down
(NOT ACTUAL SIZE.)

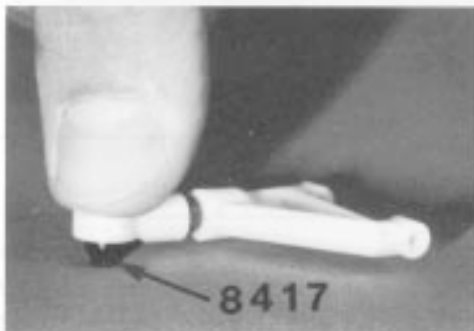

Fig. 10

Figs. 12 & 12A Go to bag 2 and remove two #8421 nylon steering blocks, two #3213 front axles, and two #6299 1/8" E-clips. Install one E-clip onto each front axle. Now push an axle into each of the #8421 nylon steering blocks from the back side of the steering block as shown. Remove two #4448 aluminum ball ends and two #4449 aluminum locknuts. Place both of the front axle steering block assemblies on a flat surface so that they sit flat. One side of the steering block will allow it to sit completely flat on the surface, the other only at the ends. Install the aluminum ball end from the top of the steering block in the outside hole as shown. Now thread the 4-40 aluminum locknut onto the ball end threads. You can use your turnbuckle wrench to hold the ball end and then tighten the nut with pliers or a 3/16" nutdriver.

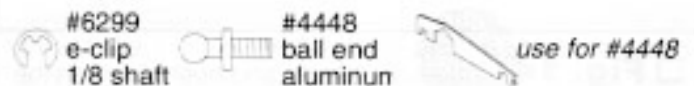
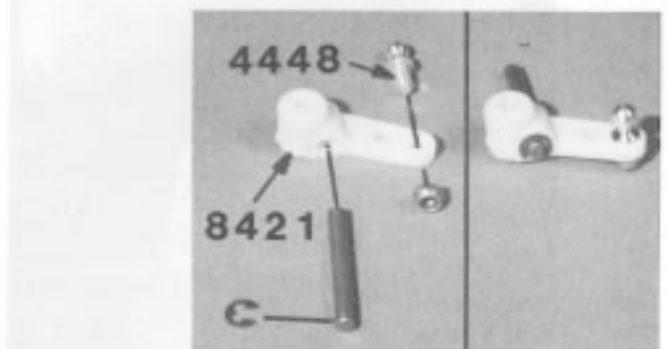
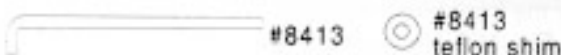

Fig. 11 Locate the two #8413 upper arm hinge pins and four #8413 teflon caster shims in bag 2. We are going to install one upper suspension arm to the right side upper arm mount. Make sure that the ball end and eyelet are closer to the back of the car than to the front, and that the shoulder side of the plastic pivot ball is facing down at the same time. (1) From the front, push the hinge pin through the front side of the upper suspension arm, (2) then slide one of the teflon shims onto the pin. (3) Next slide the pin through the upper arm mount and (4) install the other teflon shim before pushing the pin through the back side of the upper suspension arm. Make sure that you have one of the teflon shims on each side of the upper arm mount. (5) Now repeat this step to assemble the left suspension arm.



before assembly after assembly

Fig. 12 Fig. 12A

□ **Fig. 13** From bag 2 locate two #8423 kingpins, two #8431 .022 front springs, four #6299 1/8" E-clips, and eight #8425 steel shims. (1) Push an E-clip onto one end of each kingpin. (2) Place one of the front springs on the kingpin, (3) and then slide it through the pivot ball in the right hand lower suspension arm. (4) Now install the steering block assembly onto the kingpin with the flat side down and then (5) push the kingpin through the upper arm pivot ball. (6) Take four of the steel shims and install them onto the kingpin on top of the upper arm pivot ball and (7) secure them in place with a E-clip. (8) Now go ahead and install the left suspension kingpin assembly. **Note:** Make sure that the steering block is contacting the shoulder side of each pivot ball; if not, correct as necessary.

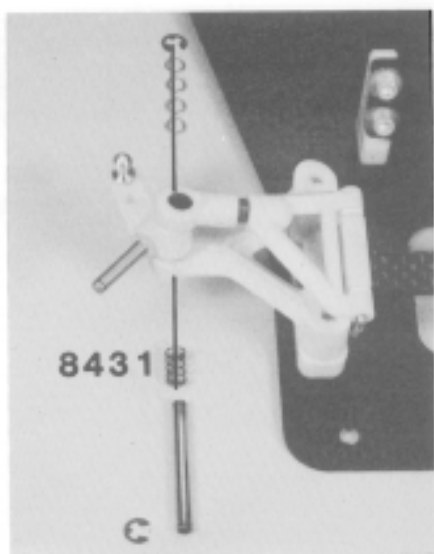
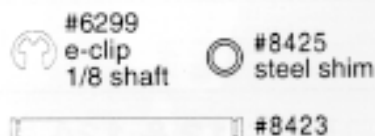

Fig. 13



BUMPER SECTION

□ **Fig. 15** Your kit comes with two front bumpers, the small bumper #8177 and the large bumper #8187. You will need to decide now which bumper you are going to use. We show the large bumper in the photos. (1) In the small bumper bag you will find two #3324 8-32 x 1/2" aluminum FHMScrews and two #6296 8-32 nylon locknuts. (2) Place the bumper on top of the chassis then screw the two FHMScrews through the two front chassis holes from the bottom. (3) Now thread on the two 8-32 locknuts on top of the bumper. (4) Tighten down the nylon locknuts, but not too tight or they will strip out. **Note:** An 11/32" nut driver (Associated #SP-82) would make this installation easier and faster.

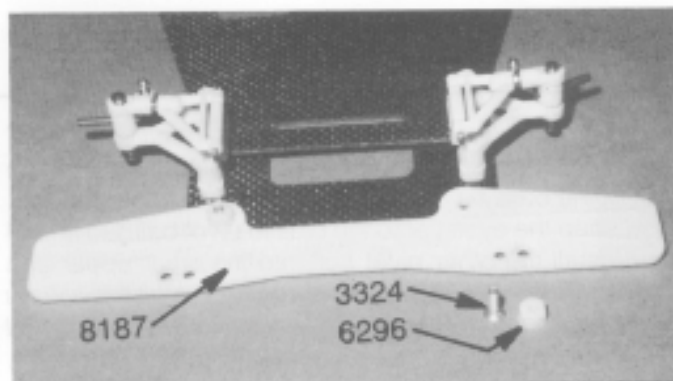
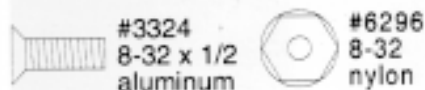

Fig. 15



□ **Fig. 14** Take your thumb and push down on the top of the kingpins so that all of the free play is taken up by the spring.

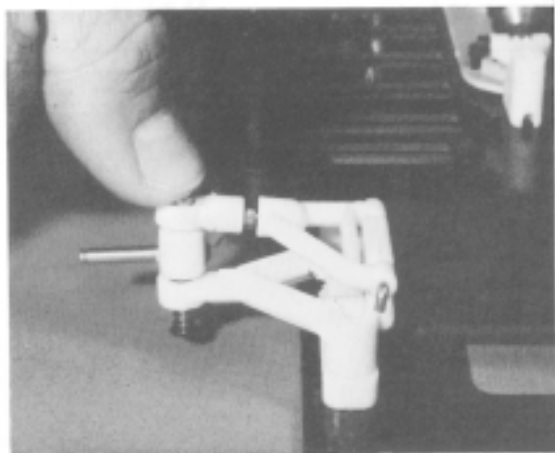

Fig. 14

T-BAR SECTION

□ **Figs. 16, 16A, 16B & 16C** From Bag 3 remove the #8190 t-bar, two #4336 steel pivot balls, the four #4335 pivot socket pieces and eight #4334 2-56 x 5/16" BHSScrews (fig. 16). (1) Lay the T-bar on your work surface as shown in the photo (fig. 16A). (2) Now install the bottom half of one pivot ball socket in the front hole of the t-bar as shown. (The bottom half of pivot socket is flat on top with a round recessed area in the center which will fit inside the hole in the t-bar.) (3) Now place one of the steel pivot balls inside the pivot socket. (4) Align the holes in the pivot socket with the holes in the t-bar (fig. 16A). (5) Place the top half of the pivot socket over the steel pivot ball; it will snap down over the ball (fig. 16B). (6) Align all of the holes and then pick up the T-bar and pivot socket, making sure to hold the pivot socket parts in place. (7) Now thread the four #4334 2-56 x 5/16" BHCScrews in the pivot socket from the bottom of the T-bar. The screws will go through the T-bar, then through the bottom pivot socket, and thread into the upper socket half. Do not overtighten the screws; just snug them down. If the ball is tight in the plastic for the front pivot, this is okay—it is not supposed to swivel. Fig. 16C shows the underside of the T-bar.

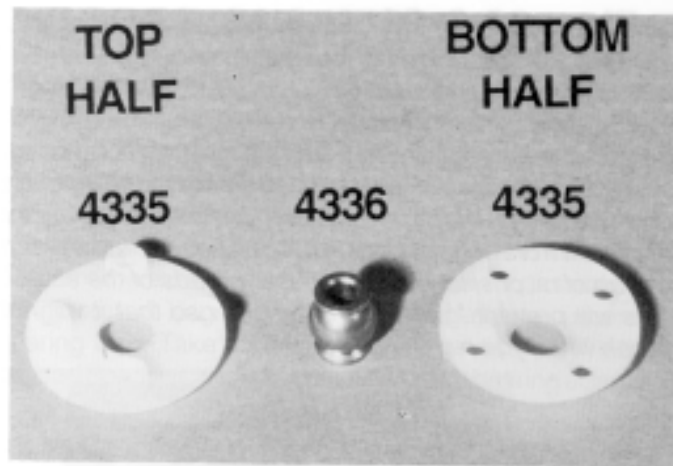

Fig. 16

Fig. 16A

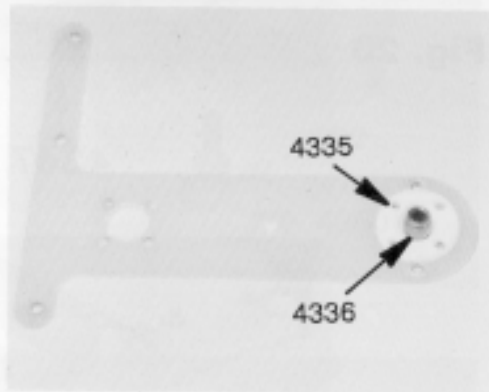

Fig. 16B

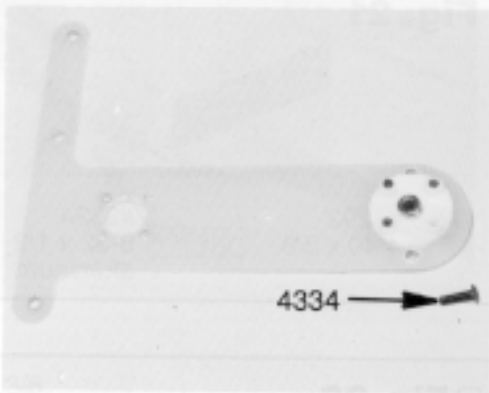
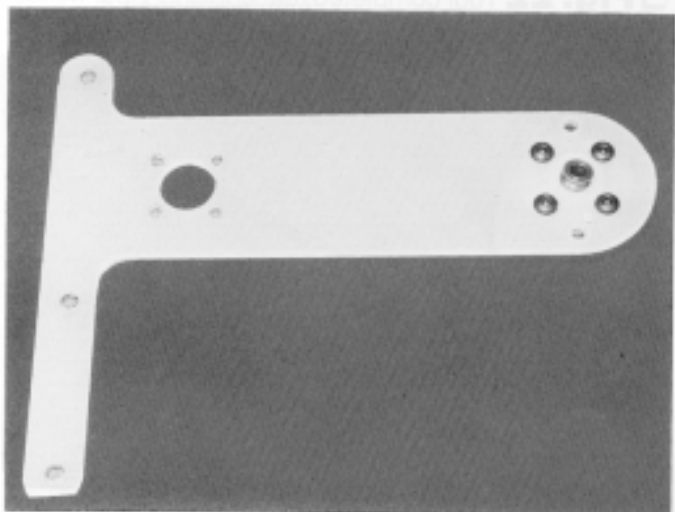

Fig. 16C



underside of T-bar

Fig. 24A

□ **Fig. 17** Now repeat the process in fig. 16 for the rear pivot. For this pivot, the ball must pivot freely in the socket while not being loose. If the ball is not pivoting freely, you can do a couple of things to correct the problem. You can equally unscrew all four screws one quarter to one half turn, but the best way is to remove the pivot ball and polish it. You can do this by placing the ball on a long 4-40 screw and securing it with a nut. You then mount the screw in a drill press and polish the ball using crocus cloth or 660 wet or dry sandpaper. Clean the ball off and reinstall it and check the movement. Keep doing this until the ball pivots freely, but is not loose.

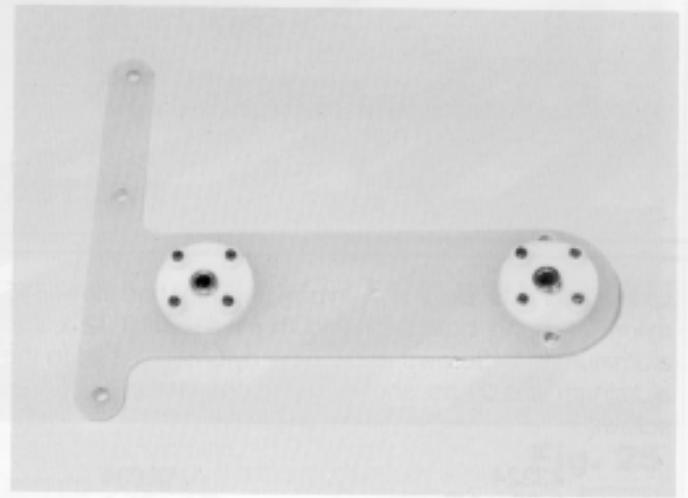
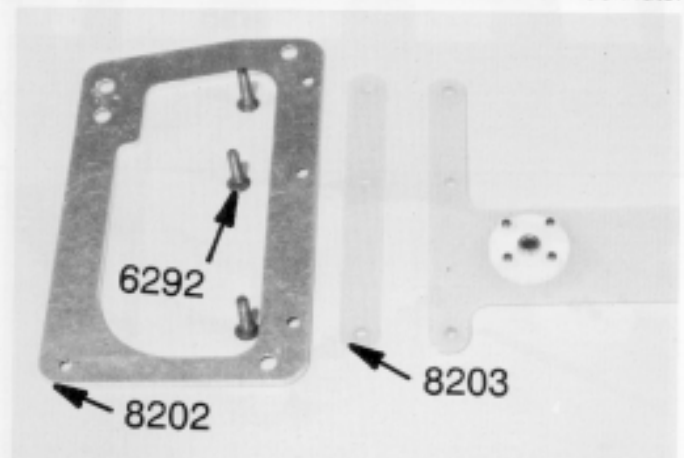



Fig. 17

□ **Figs. 18 & 18A** Take out bag 5 and remove the #8202 aluminum rear lower brace and the #8203 fiberglass T-bar spacer. You will also need to take out three #6292 4-40 x 3/8" FHSScrews and three #6937 4-40 blue aluminum locknuts (fig. 18). Place the three flat head screws in the holes at the front of the aluminum brace, from the bottom, as shown (fig. 18A). Now mount the T-bar spacer on top of the three screws, making sure that all three holes line up with the screws. (If the spacer is turned around it will not fit over the screws.) Install the T-bar over the screws and then thread on the 4-40 aluminum locknuts.



 #6292
4-40 x 3/8

 #6937
#4 locknut

Fig. 18

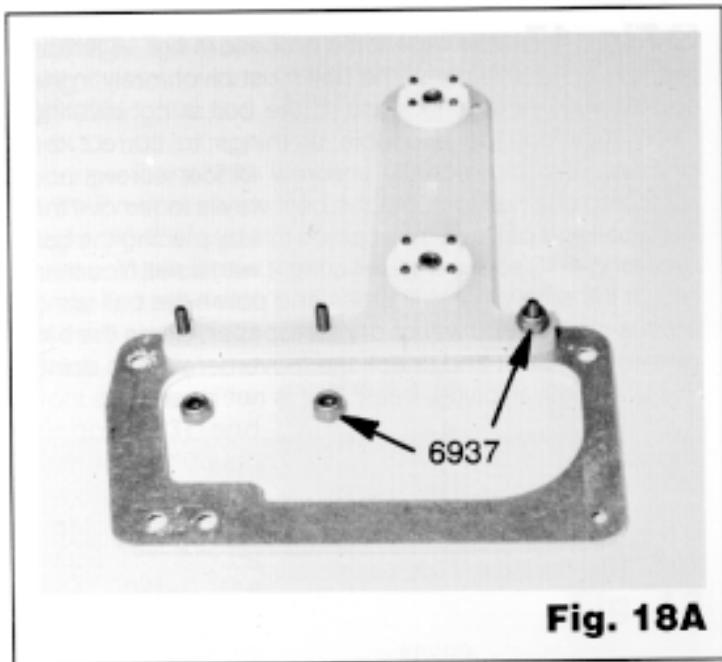

Fig. 18A

□ **Figs. 19 & 19A** In bag 5 you will find the #4345 nylon left hand bulkhead and three #3324 8-32 x 1/2" aluminum FHMScrews. Mount the nylon bulkhead to the aluminum brace as shown using the three aluminum screws.

 #3324
8-32 x 1/2
aluminum

Fig. 19

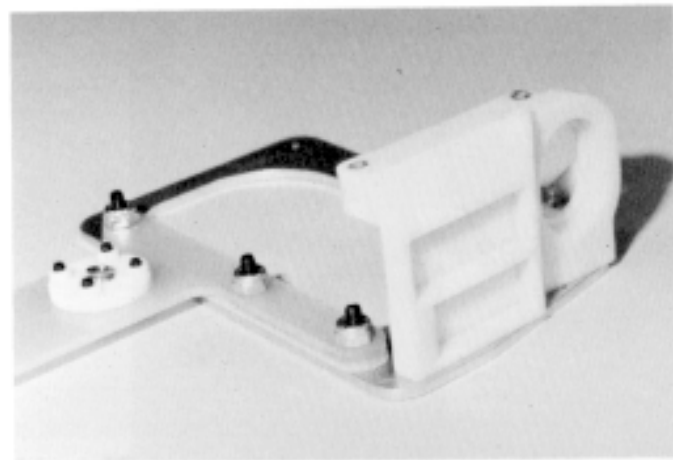
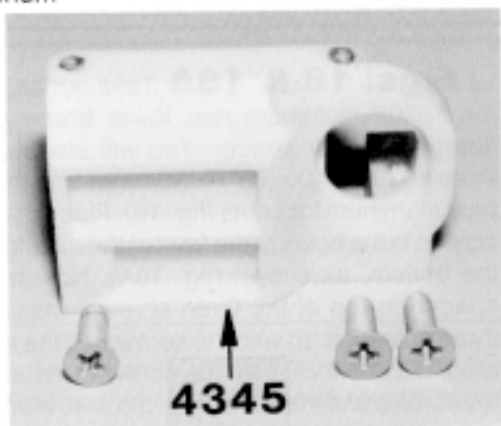

Fig. 19A

□ **Figs. 20 & 21** In the same bag 5 you will find the #4347 aluminum motor bulkhead, one #6292 4-40 x 3/8" FHSScrew and one #3324 8-32 x 1/2" aluminum FHSScrew (fig. 20). Install the #4347 aluminum motor bulkhead to the aluminum brace using both screws as shown (fig. 21). **Note:** You must be careful when threading an aluminum screw into an aluminum bulkhead. To prevent the screw from getting stuck in the bulkhead, please place a drop of oil or silicone lube on the threads of the screw. This will prevent "galling" of the screw so that it will not break when you remove the screw.

Fig. 20

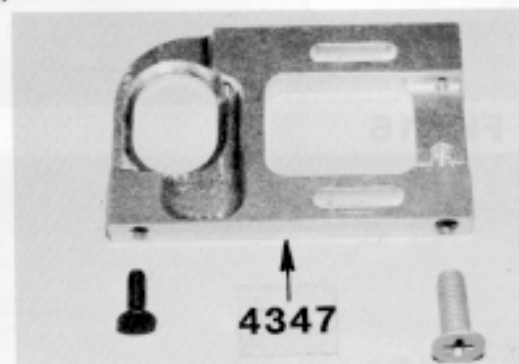
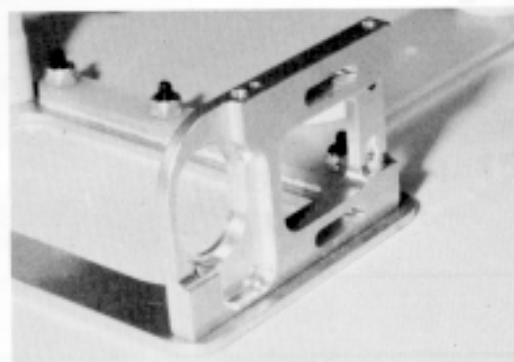



Fig. 21



 #6292
4-40 x 3/8

 #3324
8-32 x 1/2
aluminum

□ **Fig. 22** Your completed rear end and T-bar will look like this now.

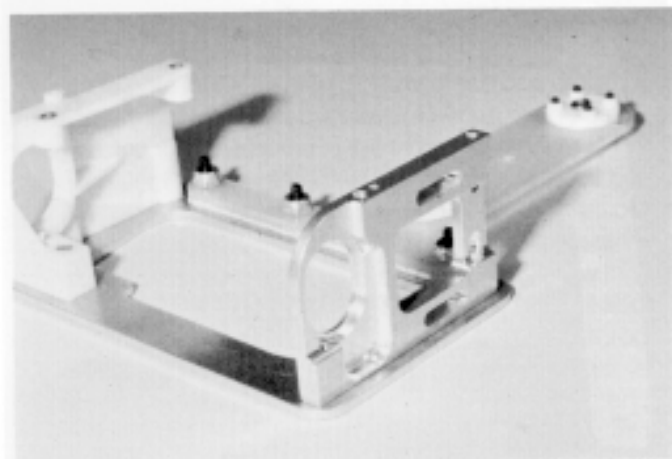

Fig. 22

□ **Figs. 23, 24 & 24A** In bag 5 you will find three sets of plastic axle bearing height adapters (#4348, #4349, & #4350). Locate the #4350 axle bearing adapters (they have a small number 2 molded on the back side). These have the bearing holes offset the farthest from the center of the adapter. Install one of the bearing adapters in each of the rear bulkheads, making sure the bearing hole is above the centerline of the adapter and not below. We want the axle to sit as high in the car as possible. In the master kit bag you will find the small, unnumbered, bearing bag. Take out two of the larger #897 1/4" x 3/8" flanged bearings and install one into each bearing adapter.

Fig. 23

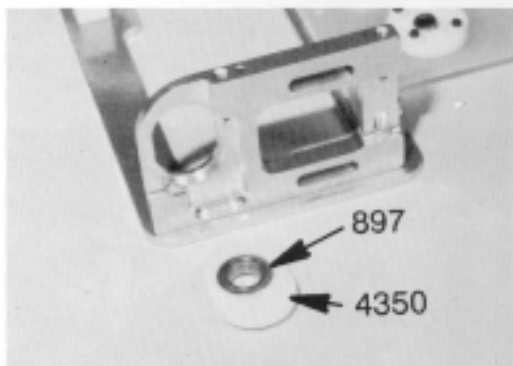
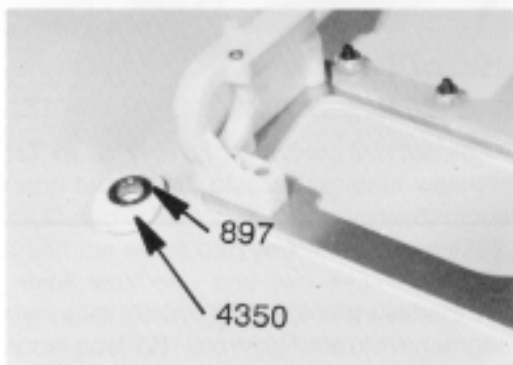

Fig. 24



 #897
1/4 x 3/8
flanged bearing

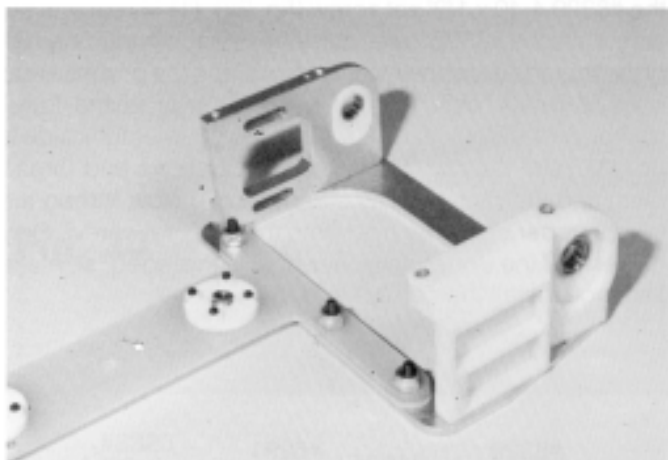

Fig. 24A

□ **Figs. 25 & 26** Now we are ready to install the rear end/T-bar assembly onto the chassis. (1) Take the #6922 4-40 x 1/2" FHSScrew from bag 3 and install it into the front T-bar mounting hole from the bottom of the chassis (second hole from the back; fig. 25). (2) Now slide the T-bar front pivot ball over the screw. Take one of the #6937 4-40 blue aluminum locknuts (from bag 3) and tighten it down onto the screw. In the same bag you will find one #6923 4-40 x 3/4" FHSScrew. Install this screw through the chassis and the rear pivot ball as shown in fig. 26.

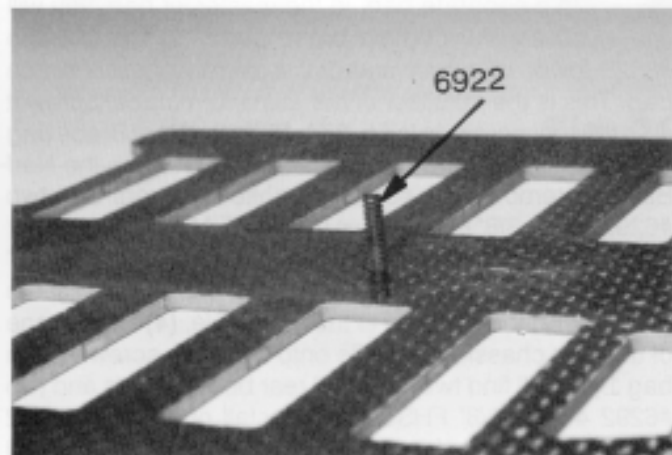



Fig. 25

 #6922
4-40 x 1/2"

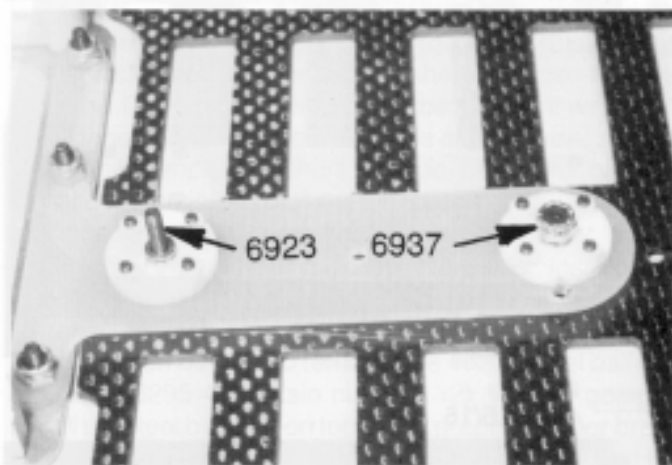

Fig. 26

 #6937
#4 locknut

 #6923
4-40 x 3/4"

□ Figs. 27, 27A, 27B & 27C Now we install the two #6932 4-40 x 5/16" SHCScrews (bag 3) as tweak screws. Next to the front T-bar pivot you will find two holes. **(1)** Thread the two 4-40 x 5/16" SHCScrews into these holes. It may be necessary to trim the sides of the front plastic pivot socket so that the 4-40 tweak screws can thread vertically into the t-bar. **Racer's Tip:** Racers glue a small piece of brass or equivalent shim stock onto the chassis where each of the two tweak screws will touch. This protects the chassis from damage and makes the tweak adjustments more consistent.

In a separate bag, in the master kit bag, you will find all of the rear chassis brace parts. **(2)** Remove the #8328 lower dampner standoff from the chassis brace bag. This is the smallest of the aluminum tubes. Screw it onto the rear screw as in fig. 27A. **(3)** In the Rear Brace bag remove two #8311 rear chassis standoffs. From the Nerf Bar bag remove two #8188 graphite nerf bars and two #6292 4-40 x 3/8" FHSScrews (fig. 27B). Mount the nerf bar to the right side of the chassis using one 4-40 x 3/8" FHSScrews, making sure that the nerf bar is on top of the chassis and the screw is in the back hole. **(4)** Thread one of the rear chassis standoffs onto the back screw. **(5)** In bag 1 you will find two #8185 3" rear body mounts and two #6292 4-40 x 3/8" FHSScrews. Install one of the #6292 FHSScrews into the front hole of the nerf bar and **(6)** thread on one of the #8185 3" rear body mounts (fig. 27C). **(7)** Now install the left nerf bar using the same steps.

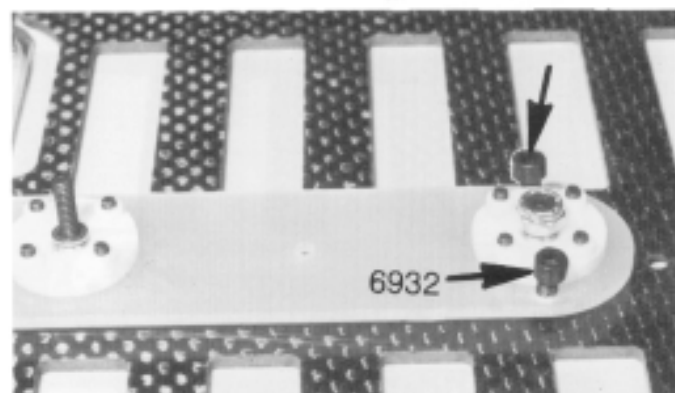

 #6932
4-40 x 5/16"

Fig. 27



 #8328

Fig. 27A

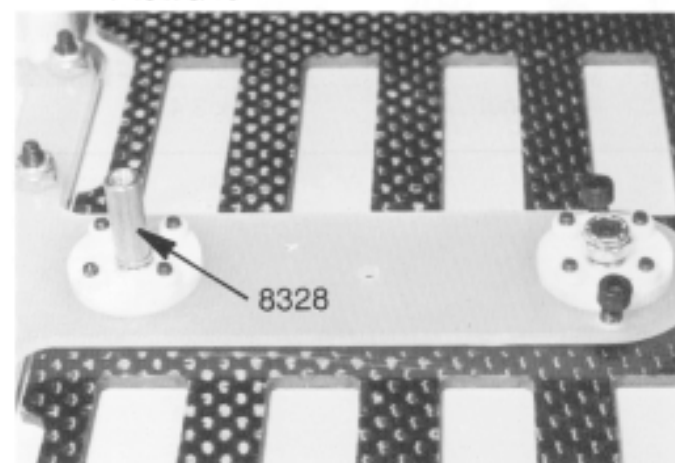
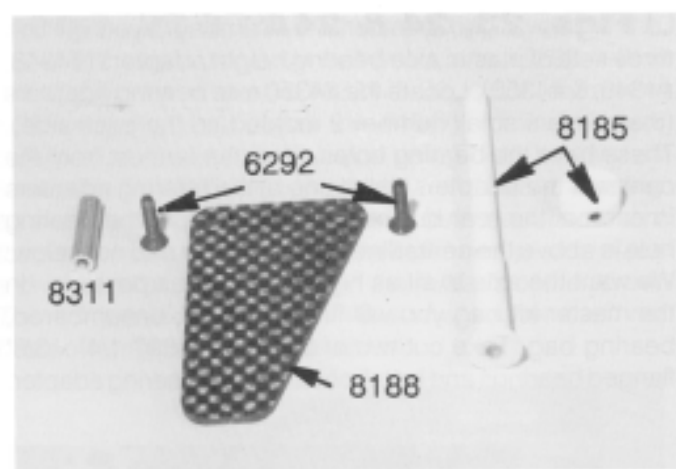

 #6292
4-40 x 3/8"

Fig. 27B

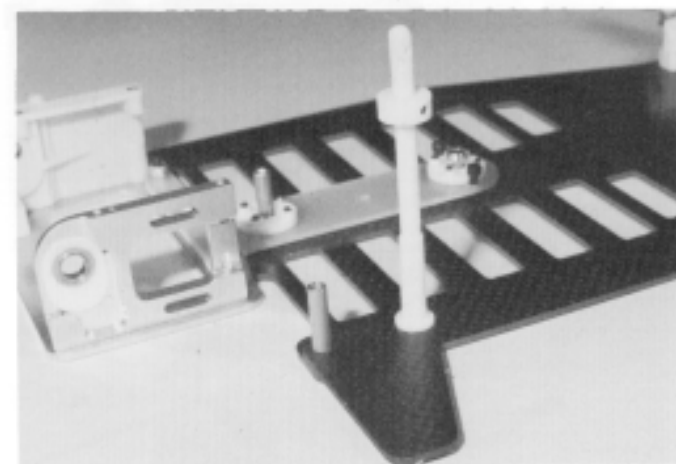



Fig. 27C

□ Figs. 28 & 29 In the Rear Brace bag you will find the #8310 graphite rear chassis brace, two #6291 4-40 x 1/4" FHSScrews, the #8329 upper dampner post, and the #8329 4-40 x 1/2" set screw (fig. 28). **(1)** Thread the set screw into the #8328 lower dampner standoff until only half of the threads are showing. **(2)** Now place the graphite rear chassis brace over the set screw that is in the lower dampner standoff. Make sure that the countersunk side is up. **(3)** Take the two 4-40 x 1/4" FHSScrews and thread them into the rear chassis standoffs. **(4)** Now thread the #8329 upper dampner post onto the 4-40 set screw. Only one end of the upper dampner post is threaded, so make sure you install the correct end.

 #8329

 #8329
4-40 x 1/2
set screw

 #6291
4-40 x 1/4"

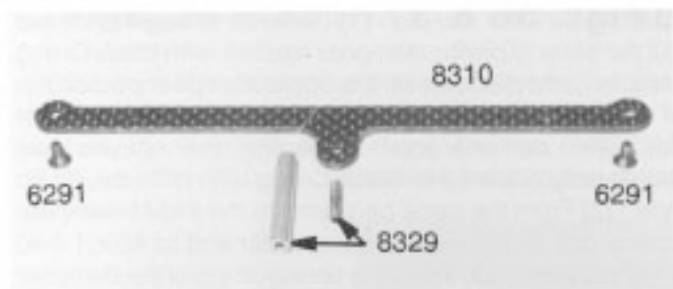

Fig. 28

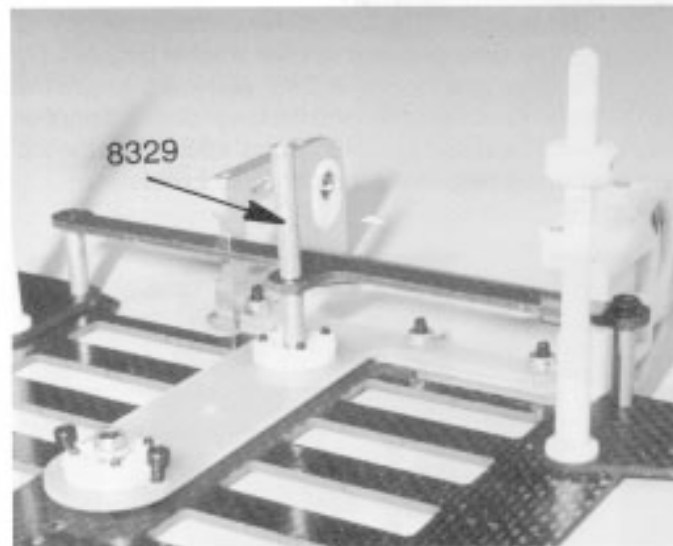

Fig. 29

□ **Figs. 30 & 31** In bag 6 you will find two #8330 black O-rings and two #4340 plastic dampner washers. Install one black O-ring in the top of each plastic dampner washer (fig. 30). In the same bag you will find two #3323 #8 aluminum thick washers, and two #4341 dampner springs. (1) Now install the two #8 aluminum washers over the upper dampner post. (2) Next install one of the dampner springs. (3) Before we install the plastic dampner washer with O-ring, coat the black O-rings with #6636 diff lube (to improve the performance of the rear pod assembly). (4) Install the dampner washer with the O-ring side facing down and the smooth side up.

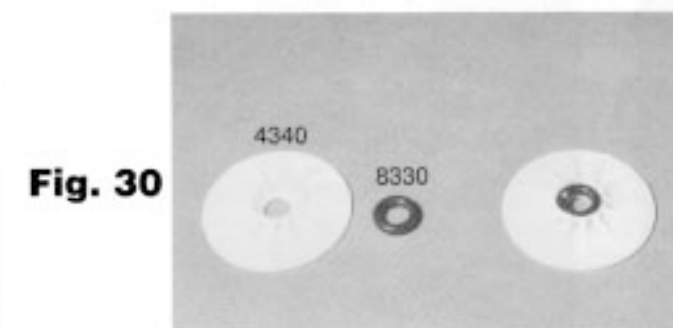

Fig. 30

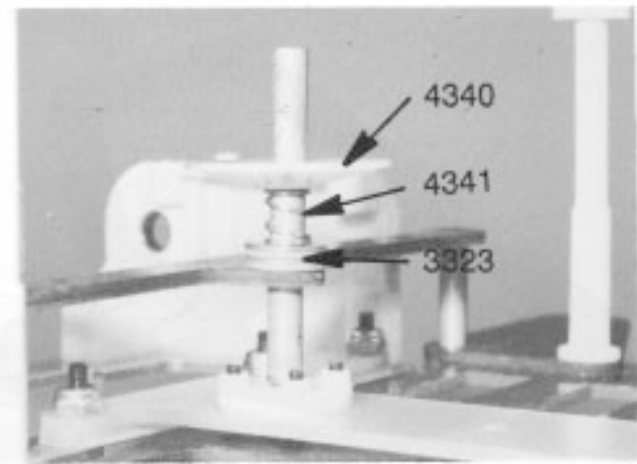

Fig. 31

CC .git 15- 14

□ **Figs. 32 & 33** Back in bag 5 you will find the #8201 graphite upper brace. The arrow in fig. 32 is pointing to the area where the dampner washers will ride. **Racer's Tip:** The Team drivers will take some #600 grit wet or dry sandpaper and sand all of the edges and surfaces smooth where the dampner washers will ride. Do this for both the top and bottom sides of the upper brace. This will help the dampner washers slide freely over the upper brace. **WARNING!** Remember to follow the earlier instructions and precautions, on page four, when working with graphite material.

Open bag 4 and remove one #6270 steel ball end and one #6295 4-40 plain nut (fig. 32). We are going to install the steel ball end on top of the graphite upper brace as shown in the photo. Now thread on the plain nut on the bottom side (fig. 33).



Fig. 32



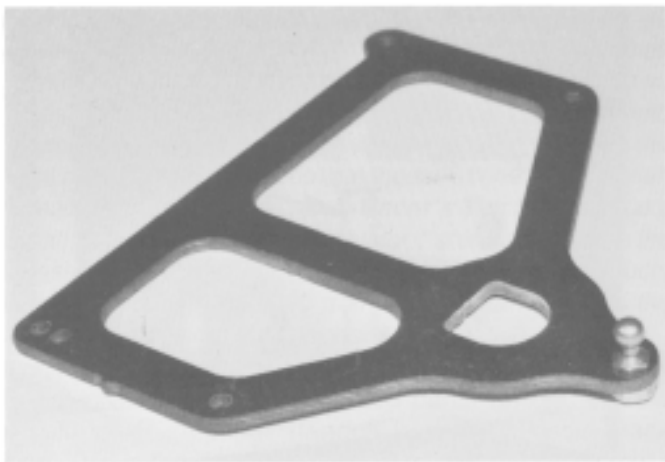

Fig. 33

□ **Figs. 34 & 35** In bag 5 you will find four #6932 4-40 x 5/16" SHCScrews. Use them to mount the #8201 upper rear brace to the rear pod assembly. Coat both sides of the brace, where the dampner washers will ride, with some of the #6636 Associated diff lube. When installed, the upper brace will fit over the #8329 upper dampner post. Fig 35 shows the upper brace and mounting screws installed.

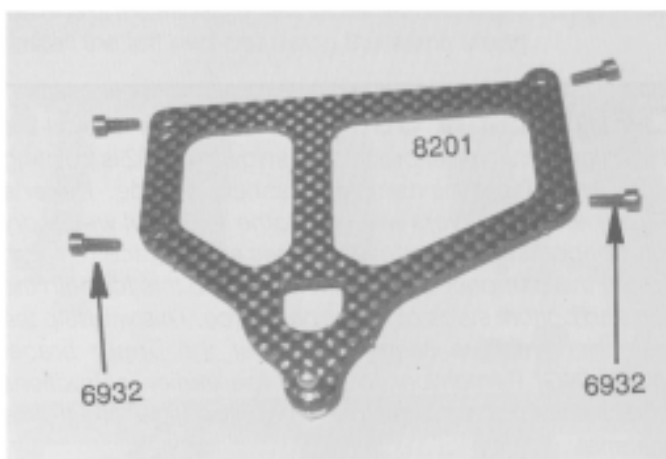

Fig. 34

□ #6932
4-40 x 5/16"

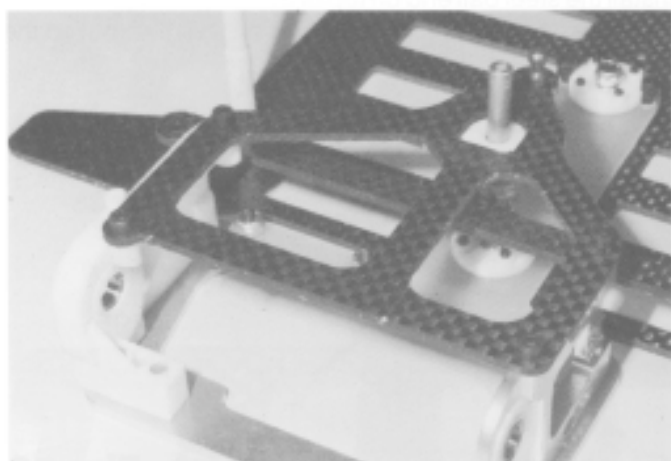

Fig. 35

□ **Figs. 36 & 37** (1) Go back to bag 6 and take out the second plastic dampner washer, with black O-ring installed, and place it over the upper dampner post on top of the graphite upper brace. Make sure the smooth side of this plastic dampner washer is facing down. (If you have not already coated this black O-ring with diff lube, do so now.) (2) From the same bag remove the #4341 dampner spring, one #4338 nylon locking collar and its #6951 4-40 x 1/8" set screw. (3) Install the spring on top of the dampner post and then (4) the nylon locking collar and (5) lightly tighten the set screw (fig. 36).

(6) Measure the spacing between the upper locking collar and the upper plastic dampner washer (Fig. 37). (7) Adjust the collar until the gap is .240". (8) Now measure the gap between the lower collar and the lower plastic dampner washer—it should also be .240". Equal spacing on the top and bottom will help make the car more consistent.

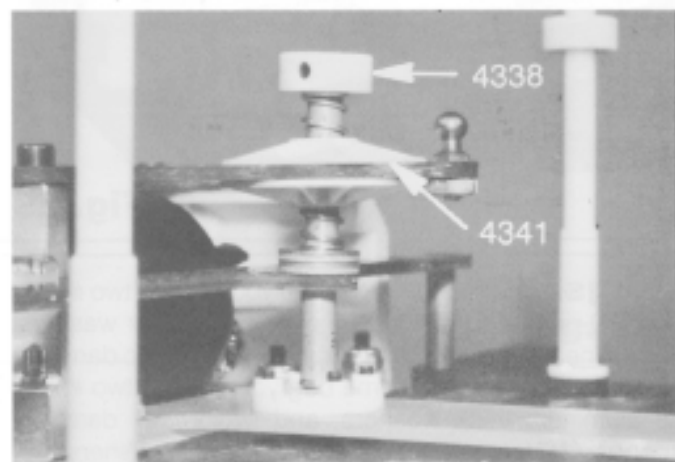

Fig. 36

□ #4341 spring □ #6951 set screw

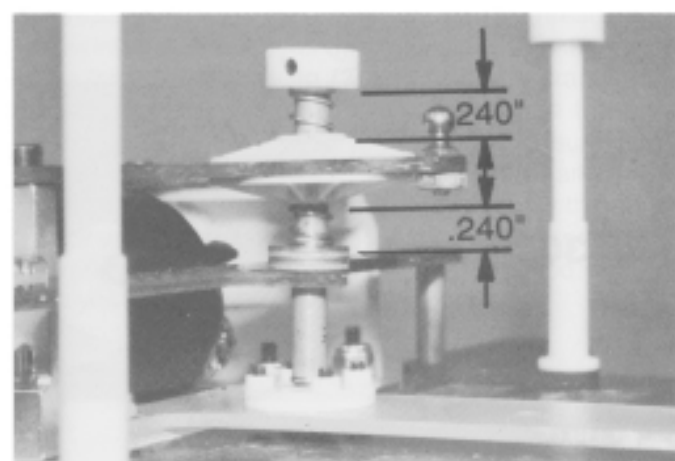

Fig. 37

□ **Figs. 38 & 39** In bag 4 you will find the #8184 shock/antenna mount and two #6922 4-40 x 1/2" FHSScrews. The shock mount has a small football-shaped, molded piece on one end; trim this off and set it aside, for we will use it a little later. Using the two 4-40 x 1/2" FHSScrews, install the shock/antenna mount on the chassis as shown.

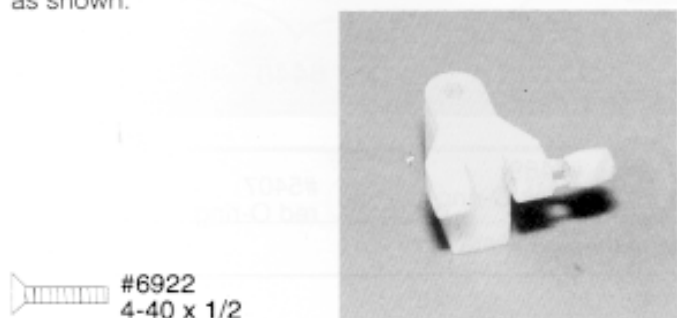

Fig. 38

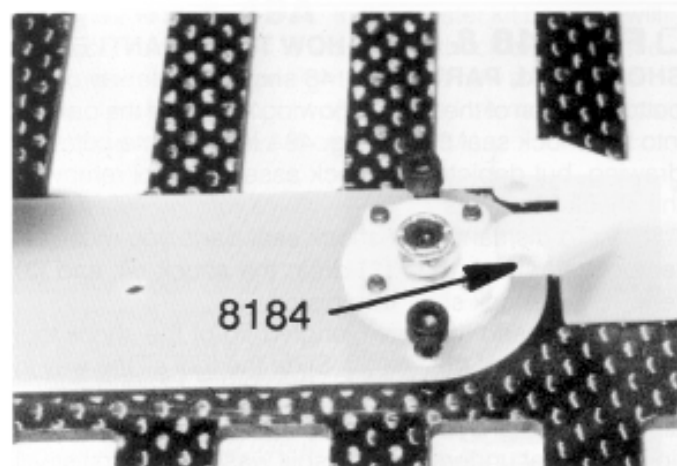

Fig. 39

Fig. 40

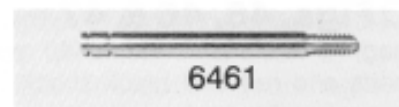
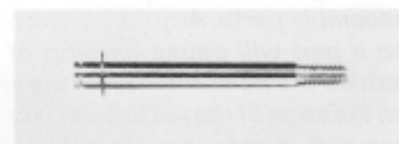

Fig. 41



Fig. 42



□ **Figs. 43, 43A & 44** In the same bag you will find the new style #6464 #1 teflon shock pistons. The new teflon pistons were carefully molded to help eliminate the possibility of burrs on the piston edge, which interfere with smooth shock action with the shock body. To properly remove the shock piston from the tree, twist the piston up as shown in fig. 43A. Twisting down will leave a rough burr on the piston, which could reduce performance of the shock. If there are any remaining burrs **carefully** remove them with a sharp hobby or X-acto® knife.

Slip the piston onto the shaft and install another E-clip in the remaining groove to hold the piston in place. Make sure both E-clips are fully seated in their grooves.

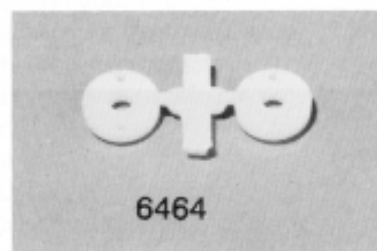

Fig. 43

#6299
e-clip
1/8" shaft

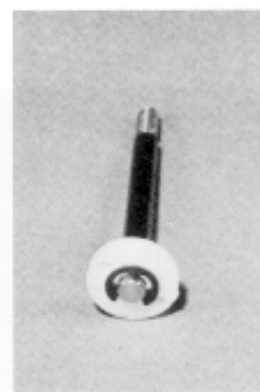

Fig. 44

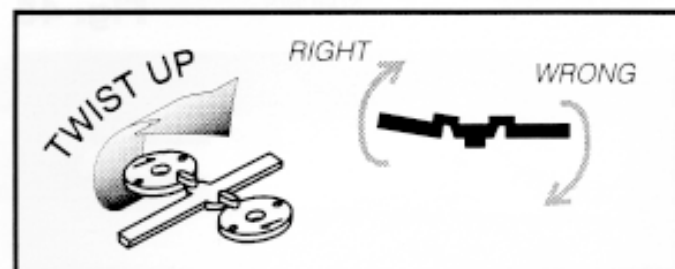
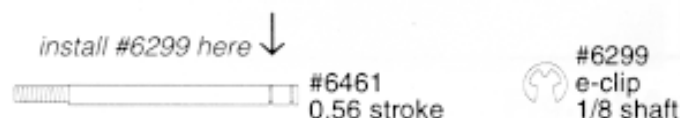

Fig. 43A

SHOCK ASSEMBLY

□ **Figs. 40, 41 & 42** Now it is time to assemble the new and improved shock for your RC10LS. In bag 4 you will find the #6461 .56 stroke shock shaft and a small roll of #6299 1/8" E-clips (fig. 42). Install an E-clip in the groove closest to the threaded end of the shaft.



☐ **Figs. 45, 46 & 47** There is another bag inside bag 4 that contains the #6440 molded shock assembly parts and red and black shock O-rings. There will be enough molded nylon parts to assemble two shocks. Fig. 45 gives the part names as they are described in the instructions. Remove two small nylon washers, one large nylon spacer, and one nylon split locking washer.

WARNING! Because of the precision tolerances of these new molded nylon parts, correct removal of the parts from the parts tree is **CRITICAL!** Using a sharp hobby knife, carefully trim each part from the parts tree. It is **EXTREMELY** important that no part of the two molding runners (on each part) be left on the shock assembly parts. Any part of the mold runner remaining on a part will cause binding of the shock shaft and reduce the performance of the shock. Use your finger on the edge of the parts to feel for burrs that you cannot see and, if necessary, carefully remove them.

In shock bag 4 you will find the #6429 shock assembly tool (fig. 46).

Remove the #5407 red and #6469 black O-rings from the same bag the molded shock parts came out of.

(1) Stand the assembly tool on end with the small tip up and install the parts on the shock assembly tool in the following order: (2) install the nylon split locking washer, (3) then one small nylon washer, (4) red O-ring, (5) large nylon spacer, (6) red O-ring, and (7) second small nylon washer. You can compare this sequence with figs. 47 and 48. Fig. 48 shows a cutaway drawing of the shock body with the parts installed.

You can skip steps 48 and 48A for now, until you need to dismantle the shock.

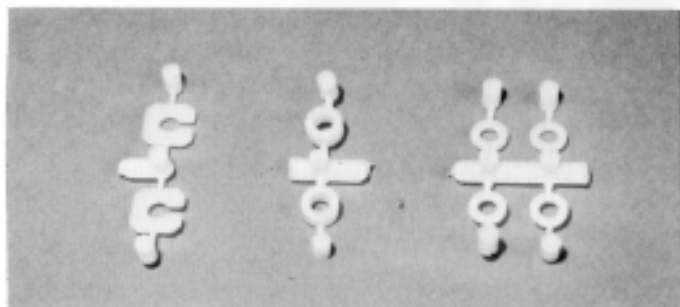

↑ nylon split locking washers

↑ large nylon spacers

↑ nylon washers

Fig. 45

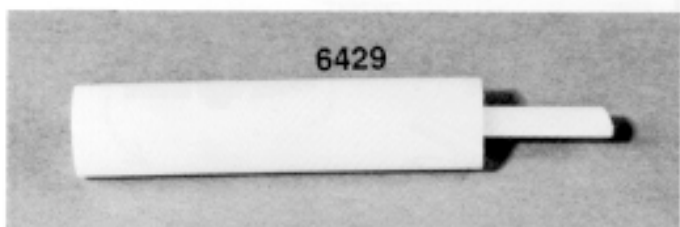
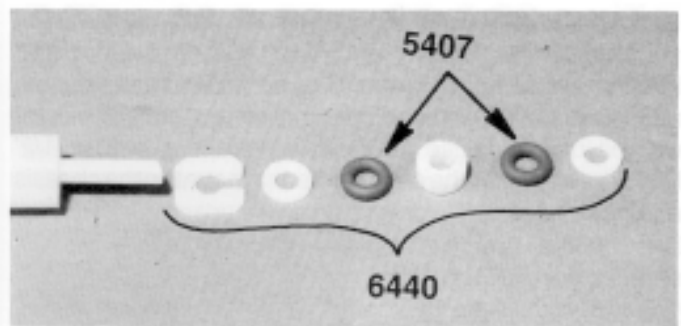

Fig. 46



○ #6469 black O-ring ⊙ #5407 red O-ring
(#6469 used in Fig. 53)

Fig. 47

☐ **Figs. 48 & 48A HOW TO DISMANTLE THE SHOCK SEAL PARTS.** Fig. 48 shows a cutaway of the bottom portion of the shock showing how all of the parts fit into the shock seal cavity. Fig. 48A is the same cutaway drawing, but depicts the shock assembly tool removing the shock seal parts.

To dismantle the shock seal parts you must: (1) remove the shock cap, (2) drain the shock oil, and (3) remove the shock shaft with piston.

(4) Insert the small, angled tip of the shock tool into the bottom of the shock. Slide the tool all the way in until the tool bottoms out against the shock body. (5) Now angle the tip slightly and slowly slide the tool down until the tip slides over underneath the split washer and first small nylon washer. (6) Now place the pointed tip of the tool under one side of the split locking washer and small nylon washer, then push firmly up until the split washer snaps out of its groove. (7) Then pull the tip of the tool down and use it to push the rest of the internal parts up and out of the cavity.

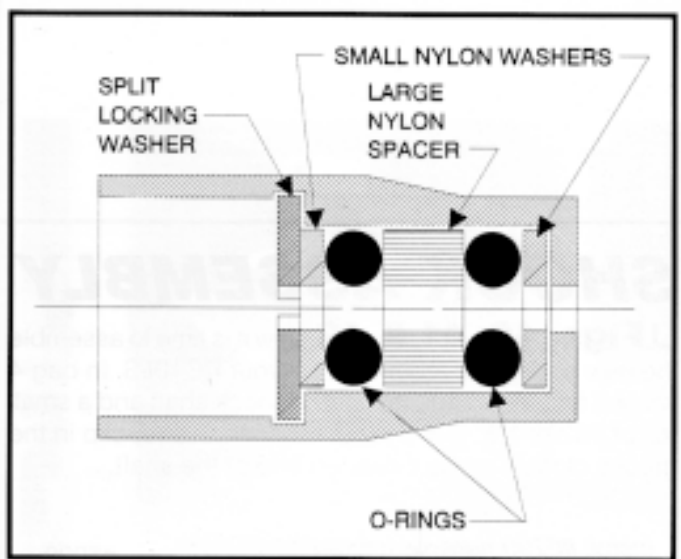

Fig. 48

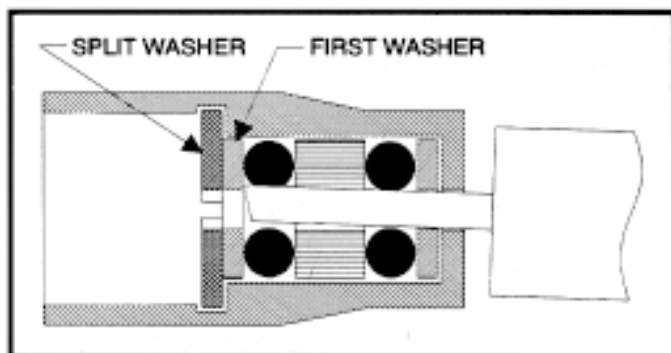

Fig. 48A

□ **Figs. 49 & 49A** In the master kit bag you will find the container of #5415 20 weight shock oil. This is the recommended starting weight oil for the new shock piston. Now apply a liberal amount of oil to the internal seal parts on the assembly tool as shown (fig. 49A).

Note: The shock oil in your kit is of high quality. But the best is Associated's #5421 Silicone Shock Oil (fig. 49), which we highly recommend. If you want to use it, then do not build the shocks with the kit oil, because the oils do not mix. This Silicone oil is one of our Speed Secrets!



Fig. 49



Fig. 49A

□ **Fig. 50** Put a few drops of oil into the bottom of the #6427 shock body. This will make installation of the internal parts easier and safer. The red O-rings are fragile, and it is very important that we do not accidentally damage them while they are being forced into the body.

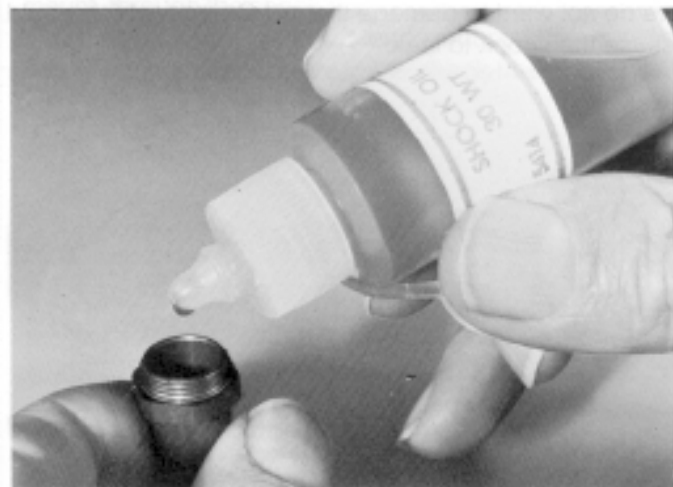

Fig. 50

□ **Fig. 51** (1) Take the shock body and the shock tool, with the internal parts on it, and slowly insert the tool into the shock body until it bottoms out and all of the parts are fitting into the cavity. If everything goes in smoothly this will allow the tip of the shock tool to be even with or just slightly out of the bottom of the shock body. If not, you may need to rotate the shock body to help it seat the parts the rest of the way into the shock cavity. (2) Now stand the shock tool on your workbench, with the shock body on top, and firmly push down on the shock body until you hear and feel the split washer snap into its groove. The new parts are of a harder material so you must push hard before it will go in. When the parts are properly installed, the end of the shock tool should be sticking out the bottom of the shock just about 1/8". (3) Once the parts have been properly snapped into place, pull the tool out. (4) Look inside the shock body for any obvious signs that the parts did not go together correctly. **MAKE SURE THE SPLIT WASHER IS FULLY SEATED IN ITS GROOVE. IF THE PARTS ARE NOT SEATED CORRECTLY, THE SHOCK WILL LEAK OR EVEN COME APART INSIDE THE SHOCK.**

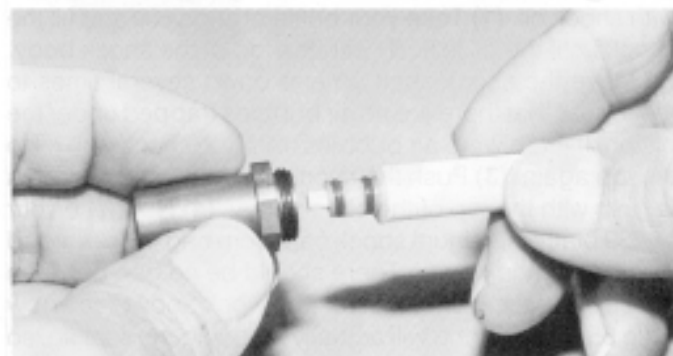

Fig. 51

□ **Fig. 52** Now we will install the shock shaft with piston. Place two drops of oil on the shock shaft and slowly insert the shaft and piston into the shock body. Pull the shaft down until the piston seats against the bottom of the shock body. We want to be careful inserting the shaft, for we do not want to damage the red O-rings, which would cause the shock to leak.



Fig. 52



Fig. 54

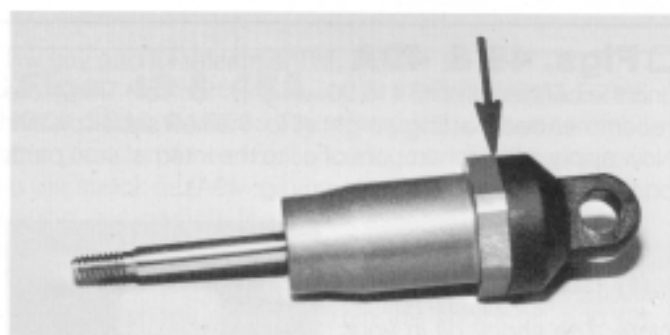

Fig. 55

□ **Fig. 53** Locate the #6469 black O-ring which we pulled out in fig. 45. Install the black O-ring over the threads on the shock body and seat it flush in the pocket at the bottom of the threads.

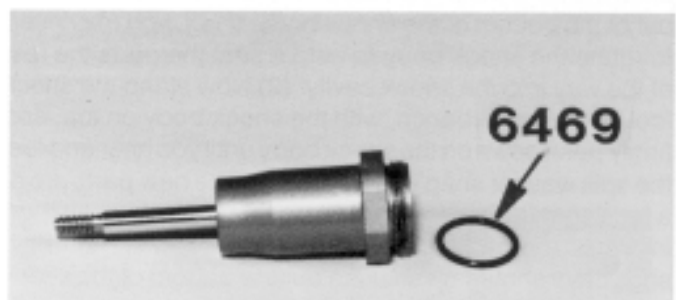

Fig. 53

○ #6469
black O-ring

□ **Figs. 56 & 57** In bag 4 you will find the #6474 spring clamp and cup parts and one #6924 4-40 x 3/8" SHCScrew. (1) The spring clamp has one hole that is slightly larger than the other. Install the 4-40 x 3/8" screw through the larger hole and then thread it into the smaller hole. (2) Now slide the spring clamp collar to the top of the shock body and tighten it just enough to keep the collar from moving (fig. 57). (3) Make sure the the side with the thin flange is away from the black aluminum shock cap.

(4) In the same bag you will find one #6274 plastic ball end cap, one nylon spacer, and one #8232 black shock spring. Slide the nylon spacer onto the shock shaft and then (5) thread the #6274 plastic ball end cap onto the shaft threads. (6) We now want to install the #8232 black shock spring and #6474 spring cup. First make sure the shaft is all the way out and that the nylon spacer is against the plastic ball end cap. (7) Slide the spring over the shock, (8) collapse it so that you can install the spring cup. When the spring cup is installed it should fit down over the nylon spacer and the end of the plastic ball end cap. (9) Collapse the shock a few times to make sure it is free and smooth (fig. 57).

(10) Now we need to adjust the tension setting on the spring and spring collar to get the correct ride height on the car. Adjust the collar so that there is a .200" gap between the collar and the hex portion of shock body. (11) Tighten down the spring clamp collar but not too tight—it just needs to keep the spring collar from moving.

□ **Figs. 54 & 55** Now we are going to fill the shock with shock oil. (1) Take your bottle of shock oil and fill the shock until the oil is flush with the top of the shock body. (2) Move the shock shaft up and down several times to make sure that there are no air bubbles trapped under the piston. If there were air bubbles, refill the shock with oil to the top again. (3) Push the shock shaft up until the piston is flush with the top of the shock body. (4) Now take your #6439 black aluminum shock cap, from bag 4, and thread it onto the shock body. There should be no gap between the cap and the hex portion of the shock body (see arrow in fig 55). The O-ring will actually be doing the sealing, so don't overtighten the cap. (5) As soon as the cap comes in contact with the body, just turn it a bit further to seat it.

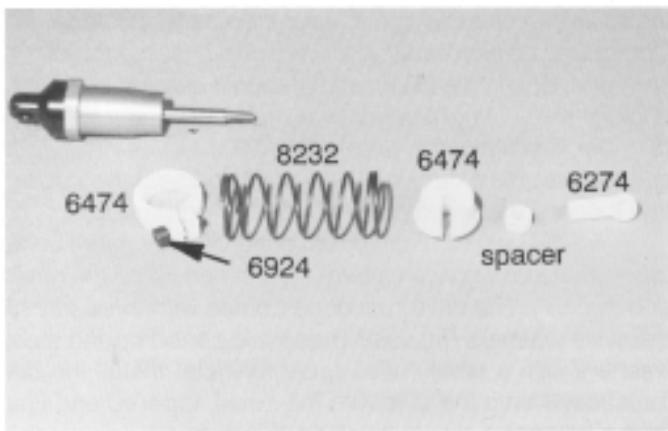

Fig. 56

#6924
4-40 x 3/8

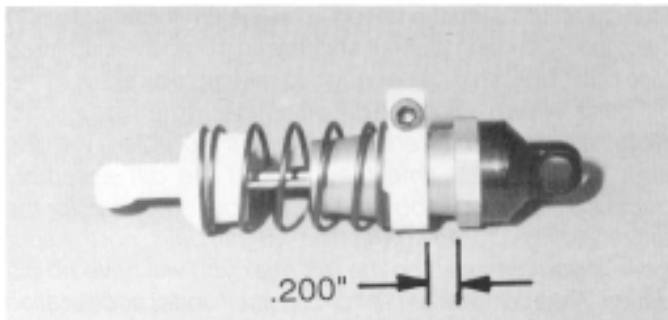

Fig. 57

□ **Figs. 58 & 59** Back in fig. 38 we removed the small shock bushing from the #8184 antenna/shock mount. Now insert that bushing inside the hole on the aluminum shock cap.

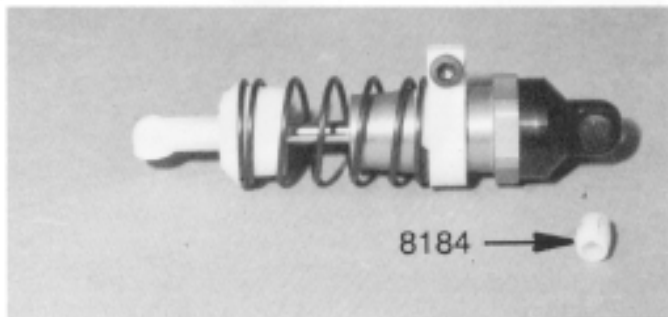

Fig. 58

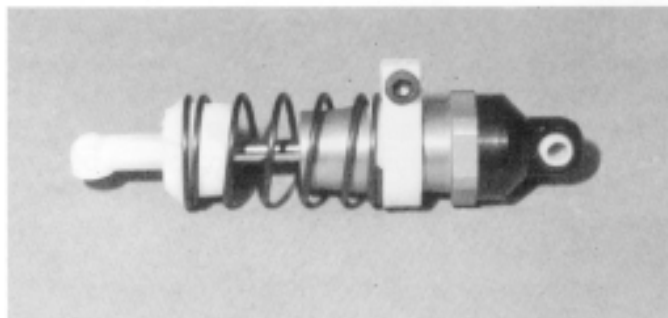

Fig. 59

□ **Fig. 60** Make sure that the shock bushing is still in the shock cap and then slip the aluminum cap end of the shock into the shock/antenna mount as shown. In bag 4 you will find the #6926 4-40 x 5/8" SHCScrew. Slide the 4-40 screw through the right hand side of the shock/antenna mount, through the shock pivot bushing and thread it into the other side of the shock antenna mount. Make sure you do not overtighten the screw; the shock has to be able to pivot freely.

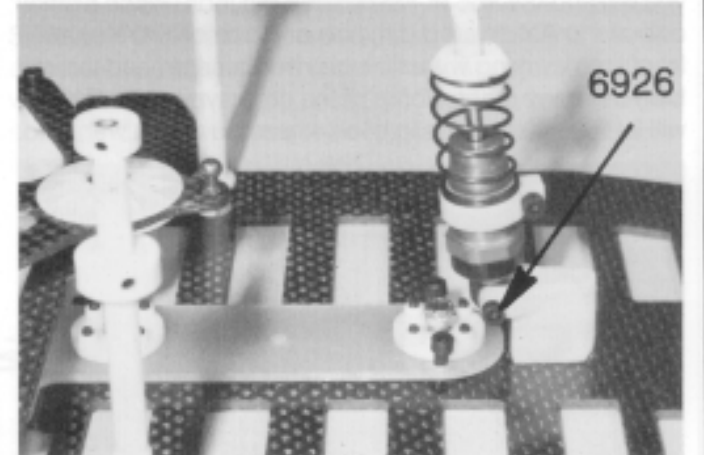

Fig. 60

#6926
4-40 x 5/8

□ **Fig. 61** Now snap the #6274 plastic ball end cap onto the #6270 steel ball mounted on the upper rear brace as shown.

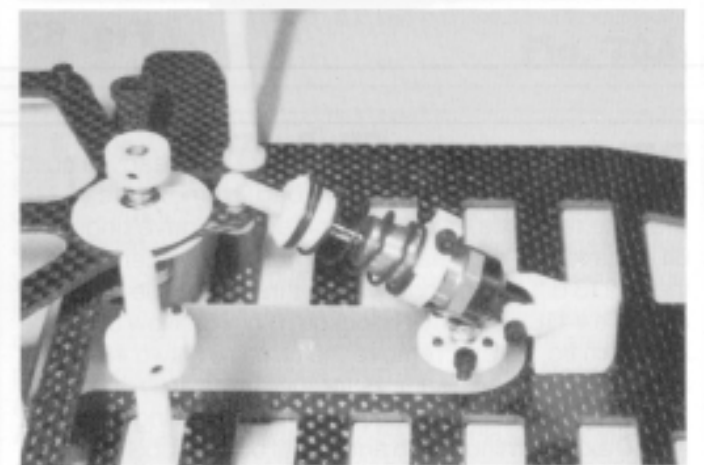

Fig. 61

REAR AXLE/ DIFFERENTIAL

□ **Figs. 62 & 63** In bag 7 you will find the #8282 81 tooth 48 pitch spur gear and the small bag containing the eight #3432 1/8" differential balls. Push each of the diff balls into the holes of the spur gear. In the kit master bag you will find the #6636 Associated diff lube. Place a small dab of the Associated diff lube on each ball. We spent a lot of time working with diff lubes and recommend this diff lube over any other. Some of the other types of diff lubes will let the differential slip even when you do not want it to.

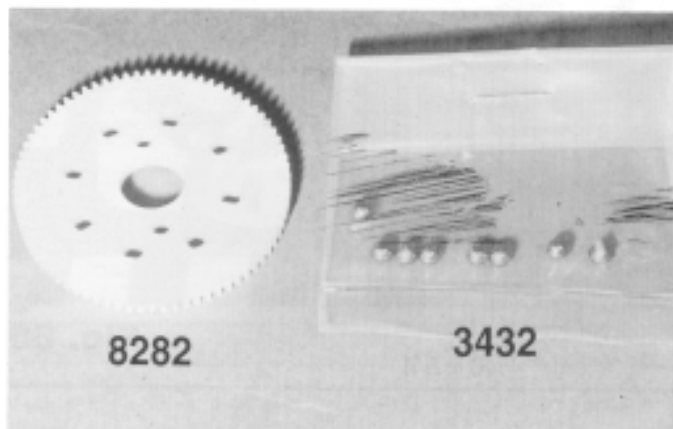

Fig. 62



Fig. 63

□ **Figs. 64, 65 & 66** We are now ready to build the rear axle assembly. (1) From bag 7 remove the #8210 graphite rear axle, two #6625 differential drive rings (fig. 64), one #8211 right hand wheel hub/diff spacer, (fig. 65) the #8213 diff thrust cone with its three belleville washers, and one #4185 8-32 nylon locknut (fig. 66). Now open the bag from fig. 23 and remove the remaining two #897 1/4" x 3/8" flanged ball bearings for the rear axle.

(2) Slide one of the #6625 diff drive rings onto the #8210 axle aluminum hub and seat it on the hub. It is easier to do if you hold the axle upright (hub side up). (3) Now dab a small amount of Associated diff lube in the center hole

the spur gear with balls and seat it onto the axle hub. (4) Center the second #6625 diff drive ring onto the top of the spur gear and balls. (5) Insert a flanged bearing into each end of the #8211 right hand wheel hub/diff spacer (fig. 65). (6) After installing the bearings, slip the wheel hub/diff spacer over the axle hub. Make sure you seat the hub so that it centers itself on the outer drive ring (fig. 66).

(7) The #8213 diff thrust cone is a aluminum cone tapered at one end with a larger recessed lip on the other end (fig. 67). The diff thrust cone comes with three #8213 belleville washers (fig. 66). These are coned spring steel washers with a small, raised, center hole. Install the diff thrust cone onto the axle with the small, tapered end first (when tightened down, it will apply pressure against the inner race of the outer ball bearing). (8) Now install all three of the belleville washers with the small, raised hole up. They must fit inside the raised lip of the diff thrust cone. (9) Take the 8-32 nylon locknut and thread it onto the aluminum axle hub. Tighten it just enough to take up any slack in the diff parts. We will adjust the diff a little later in the instructions.

Note: A lot of new racers think there is a problem with the spur gear the first time they look at the diff assembly because the gear wobbles. This wobble is normal, for the diff drive rings clamp against the 1/8" diff balls, not the spur gear. If you clamped on the diff gear you will have no diff action. The spur gear will self center itself under acceleration when you apply the throttle.

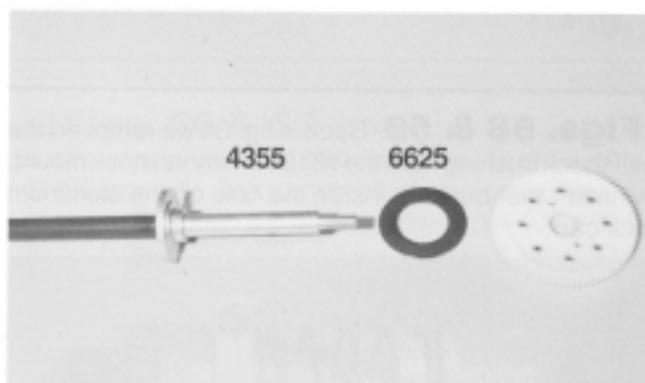
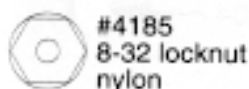

Fig. 64



#4185
8-32 locknut
nylon



#897
1/4 x 3/8
flanged bearing

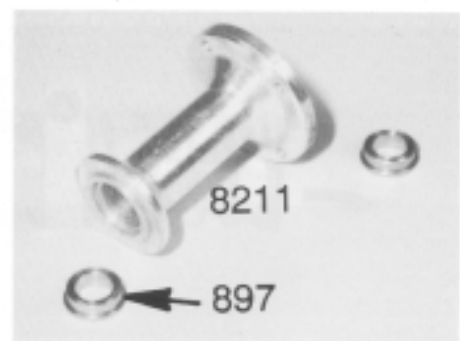
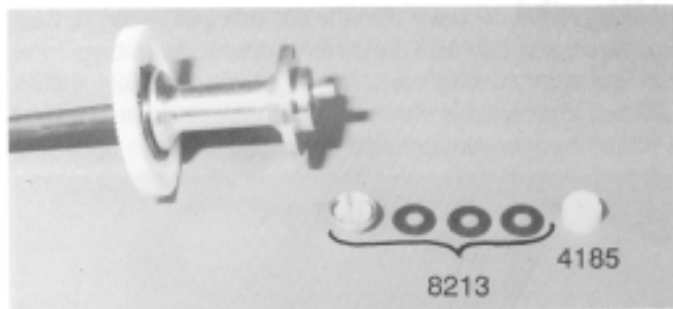

Fig. 65



#8213 diff thrust cone #8213 belleville washers #4185 8-32 nylon locknut

Fig. 66

□ **Figs. 67 & 68** In bag 7 you will find two #8321 rear axle spacers. The spacers have a stepped surface on one side which is designed to ride against the inner race of the #897 bearings. Install one of the rear axle spacers onto the graphite portion of the rear axle with the stepped side facing away from the #8211 wheel hub/diff spacer (fig. 68). Now slide the rear axle through the bearings in the rear pod assembly from the right side.

Fig. 67



8321

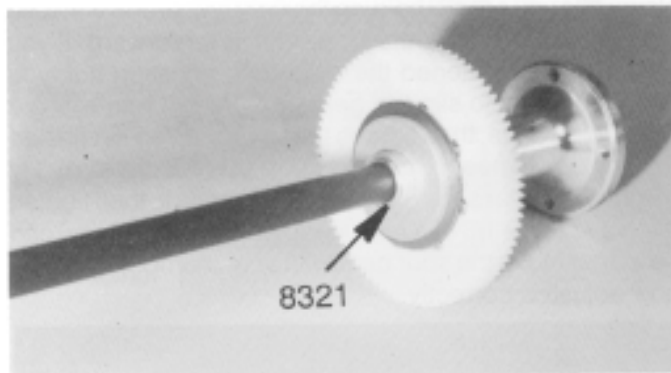

Fig. 68

□ **Figs. 69, 70 & 70A** (1) A small portion of the graphite axle will be extending out the left hand side of the rear pod assembly. Install the second #8321 rear axle spacer onto this portion of the rear axle. Make sure the stepped side of the spacer is facing the bearing in the bulkhead. (2) Back in bag 7 you will find the #8212 left wheel hub and its 10-32 x 3/16" set screw. Thread the set screw into the left wheel hub (fig. 69) and then (3) slide the hub onto the graphite axle (fig. 70). We want to tighten the set screw just lightly enough to make a mark on the graphite axle so we can just see it. (4) Now remove the left

wheel hub. (5) File a flat spot on the axle, where the mark is, for the set screw (fig. 70). This will help if you need to remove the axle again. This way the mark will be below the surface of the axle so it will allow the hub to come off easily. The flat spot also helps keep the set screw from trying to rotate around the axle—which would damage and weaken the graphite rear axle. (6) Now reinstall the #8212 left wheel hub.

(7) We need to set the end play on the rear axle to .004" to .005" (about the thickness of a piece of paper). Slide a piece of paper between the wheel hub and the rear axle spacer (make sure the set screw is correctly aligned with the flat spot on the axle). (8) Tighten down the set screw and then recheck the end play. Your installed axle assembly should look like this.

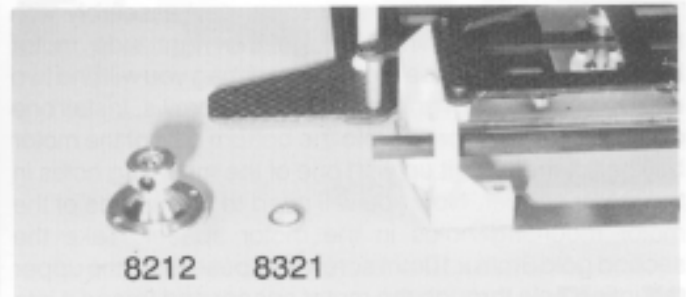

Fig. 69

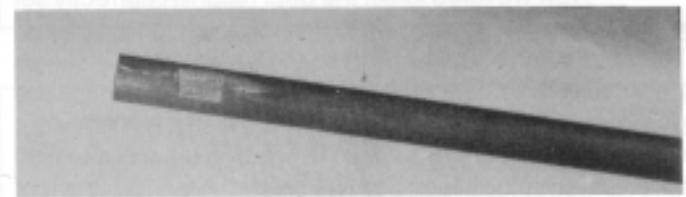

Fig. 70

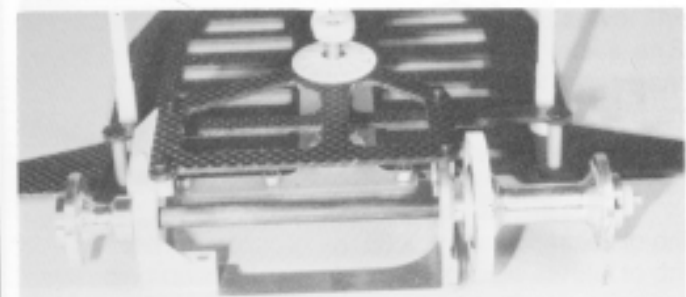

Fig. 70A

□ **Figs. 71, 72 & 73** Now we need to set up and install the motor. Your kit does not come with a motor or pinion gear. It may be helpful to talk with your dealer about what will be the right motor/gear combination for your application. Follow your speed control and motor instructions' recommendations for type and number of capacitors and/or diodes to be installed. These are to help prevent radio interference from the motor. **Note:** If you have a high frequency electronic speed control, Reedy Modifieds has an effective #745 Schottky diode for your motors; it will improve the reliability and performance of your speed control and motor. You will find more information

on this in the tuning and tips section at the end of the manual.

If you are using any type of motor connector plug to match your speed control plug, now is the time to solder it to the motor.

Push your pinion gear onto the motor shaft. (Again, if you are not sure what gearing to run, ask your dealer.) Mount the pinion gear onto the motor shaft using the set screw supplied with the pinion gear. The pinion gear should be sticking out beyond the end of the motor shaft about 1/16" (fig. 71). Now install the #8110 motor spacer (in a separate bag inside the kit box) onto the motor (fig. 71).

Note: with some of the larger pinion gear sizes, you must remove the pinion gear in order to install the motor spacer, and then reinstall the pinion gear.

Insert the motor into the rear pod assembly with the pinion gear coming through the right side motor bulkhead (fig. 72). In the Motor Spacer bag you will find two #6515 3mm x 10mm gold metric motor screws. Install one of the 3mm motor screws into the bottom hole of the motor bulkhead, then line it up with one of the mounting holes in the motor spacer. Now you will need to line up one of the motor mounting holes in the motor spacer. Take the second gold 3mm x 10mm screw and push it into the upper mounting hole through the motor spacer and thread it into the motor.

Now we need to set the gear mesh. A correctly set gear mesh is very important to a car's speed and run time. The gear mesh should be set so the gears are as close as possible without touching (fig. 73). You should check the gear mesh all around the spur gear in case it is slightly out of round. It is VERY important that you end up with a paper-thin clearance between the two gears.

Fig. 71

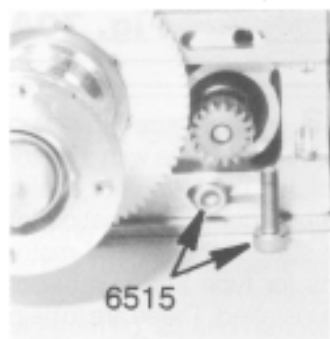
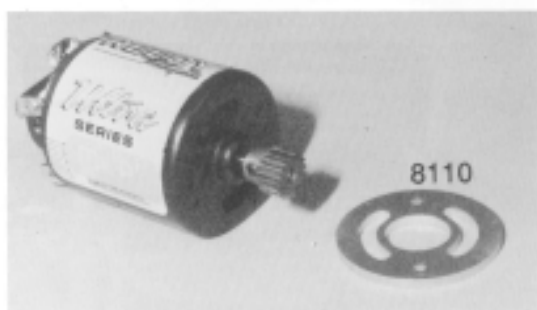

Fig. 72

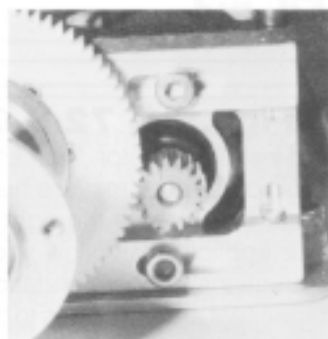



Fig. 73

 #6515
3 mm x 6 mm
metric (gold)

 #6515
3 mm x 10 mm
metric (gold)

Fig. 74 You will find the tire box inside the kit box. Remove the two #8165 rear tires and wheels. In bag 7 you will find a small bag containing the eight #6924 4-40 x 3/8" SHCScrews. Now use four of these screws to mount each of the rear wheels and tires.



 #6924
4-40 x 3/8

Fig. 74

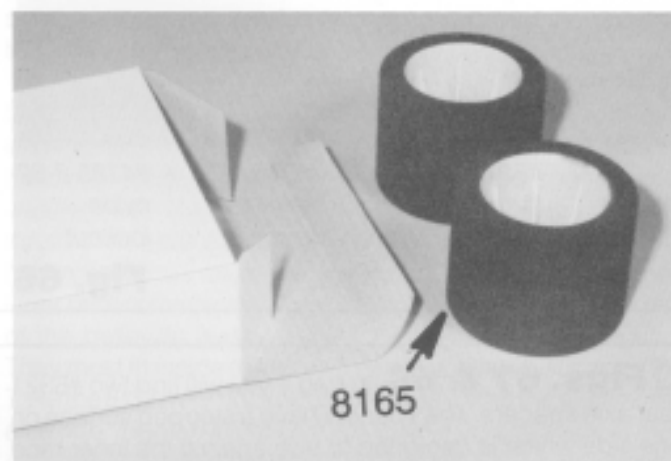
Fig. 75 Now it is time to make the final diff adjustments. Hold the left hand tire and wheel in your left hand and the right hand tire and wheel in your right hand. Now while you are still holding the right wheel and tire, take your right thumb and rotate the spur gear forward. If you have not overtightened the nylon diff adjusting nut, you should be able to slip the gear and make it rotate. If the gear does rotate, then tighten the diff adjusting nut (inside the right rear wheel) one flat of the nut (1/6 of a turn). Try to rotate the gear again. If you can still rotate it, then tighten the nut another 1/6 of a turn. Keep doing this until you can no longer move the spur gear with your thumb. Your diff is now adjusted correctly.

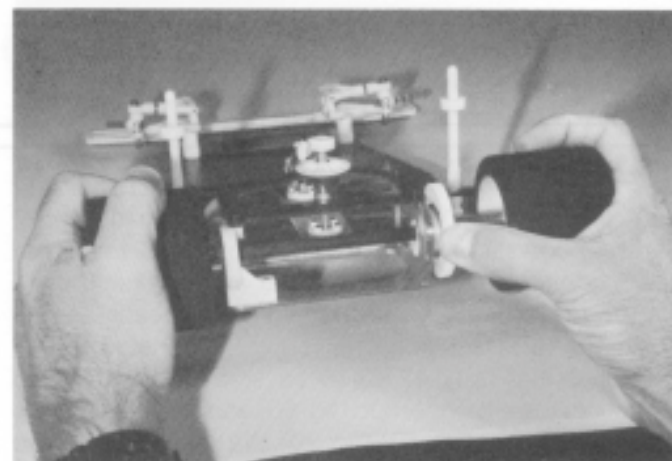

Fig. 75

□ **Figs. 76, 77 & 77A** Remove the #8141 front tires and wheels from the tire box, and four #3655 1/8" x 5/16" flanged ball bearings for the front wheels in the bearing bag. First look at the center of the front wheels (where the ball bearings are going to go). You will notice the wheel center is shaped differently on one side than it is on the other. The smooth side is the outside of the wheel and the stepped or indented side is the inside of the wheel. Go ahead and install all four #3655 bearings into the two front wheels (fig. 76).

In bag 2 you will find six #4187 nylon front axle washers and two #6299 1/8" E-clips. Install two nylon washers onto each front axle (fig. 77). Now install the front wheels and tires, making sure that the indented side of the wheels go on first. Install one more nylon washer and secure each wheel and washer with a E-clip (fig. 77A).

Fig. 76

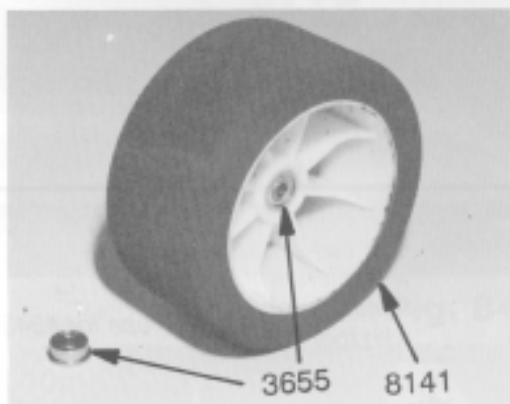
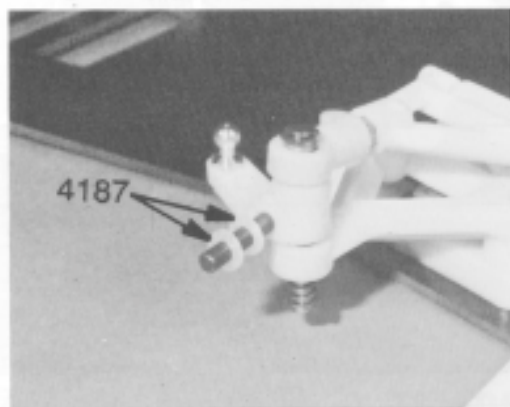

Fig. 77



○ #4187 washer

○ #3655 1/8 x 5/16 flanged bearing

⌘ #6299 e-clip 1/8 shaft

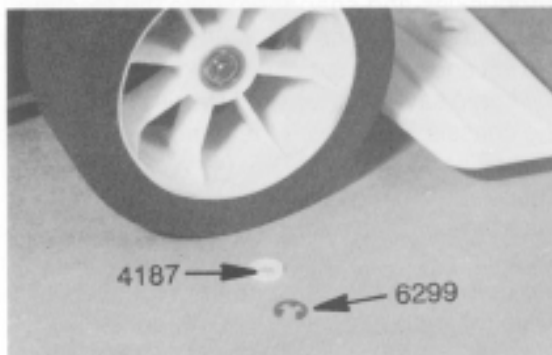

Fig. 77A

□ **Fig. 78** Now we need to install the front body mounts. Your kit comes with two different size body mounts (small #4220, and large #3320). Which mount you install will depend upon the body that you are going to run. For the photos we are going to install the #3320 body mount. The two mounts are in bag 1 along with the two #3324 8-32 x 1/2" aluminum FHMScrews. Mount the body mounts on the outside hole on each side of the front bumper using the two 8-32 screws. **Note:** If you are going to install a stock car style body onto a RC10L, you will need a #8186 rear body mounts (which must be mounted on top of the rear chassis brace), and #8304 front body mounts.

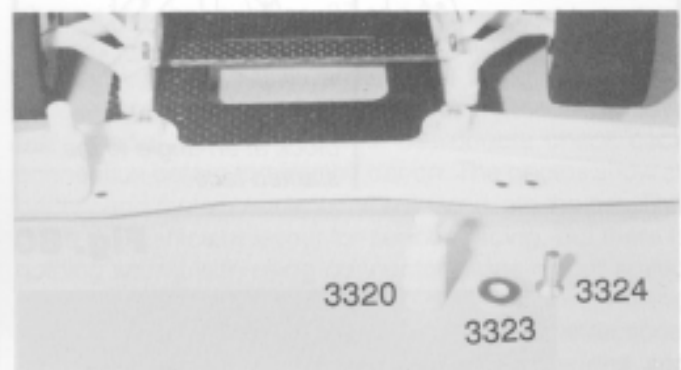

Fig. 78

⌘ #3324 8-32 x 1/2 aluminum

STEERING SERVO

□ **Figs. 79, 80 & 81** Now we need to start installation of the steering servo. For the 1/10 scale cars we recommend using a standard large size servo. This would be a 94102 (fig. 79), or 94737 from Airtronics; an S-148, 9101, or 9301 from Futaba. Now go back to bag 2 and remove the two #8435 servo mounting blocks. We are going to drill two holes into each servo mounting block using a #43 drill bit (a 3/32" drill bit will work if you are very careful).

The drawings in fig. 80 show which holes to drill depending upon your servo selection. Be careful to drill the holes at the correct angle to the block.

In bag 2 you will find four #4145 aluminum SHCScrews and four #6936 #4 aluminum flat washers. Place a #4 flat washer onto each aluminum screw, then thread the screws into the servo mount as shown in fig. 81.

Fig. 79

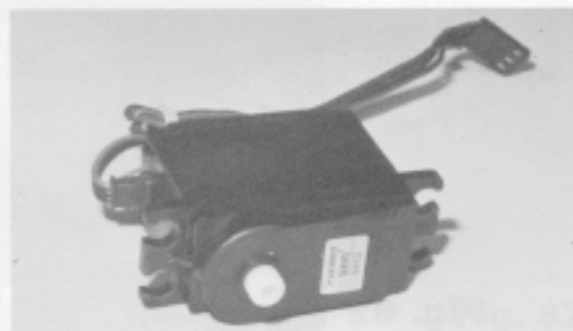

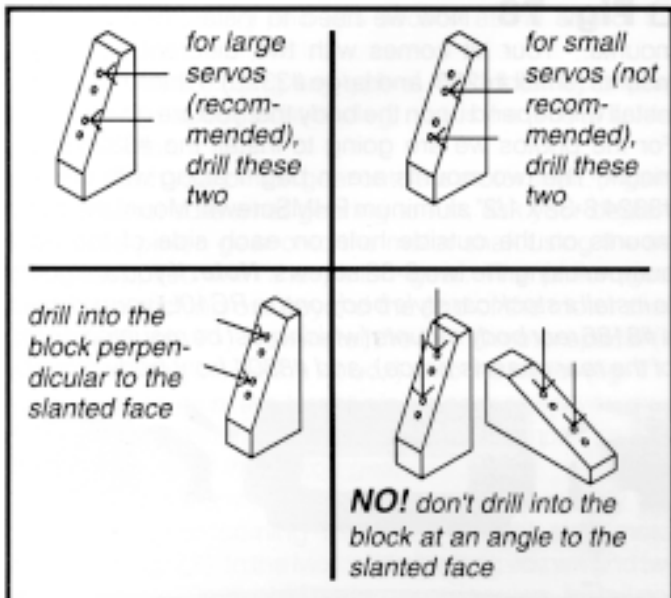
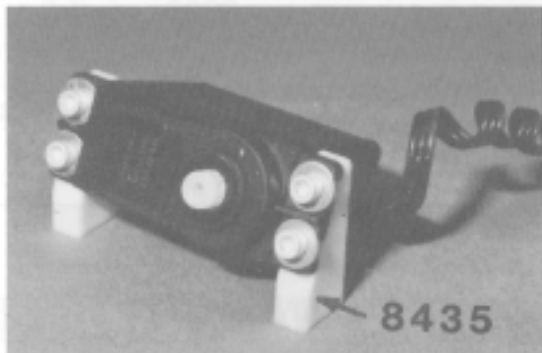

Fig. 80





-  #4145 4-40 x 5/16 aluminum
-  #6936 #4 flat washer aluminum

Fig. 81

□ **Fig. 82** In bag 2 you will also find the #8445 Kimbrough servo saver and adapter mounts and two #4448 aluminum ball ends. Screw the two aluminum ball ends into the two outside holes on the servo saver. Find the appropriate adapter for your servo and install it on the servo. Now install the servo saver onto the adapter. Do not completely tighten the servo saver mounting screw until after you have installed the radio and centered the servo trim.

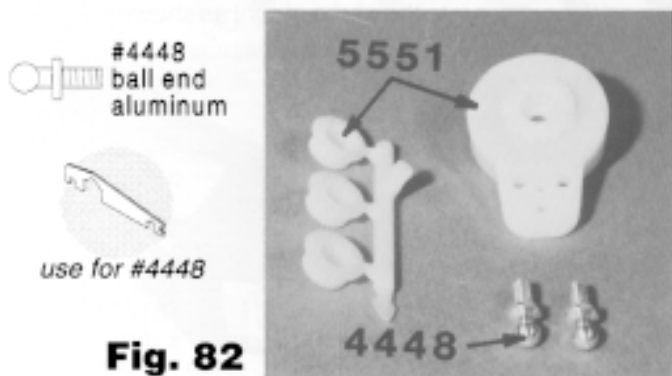

Fig. 82

□ **Figs. 83 & 83A** In bag 2 you will find two #8437 turnbuckles and four #6274 plastic ball end caps. Screw two plastic ball end caps onto each of the turnbuckles. Each of the turnbuckles has both left and right handed threads, so each plastic ball end cap will thread on in opposite directions. Match the length of the caps and turnbuckles to the actual scale drawing below.

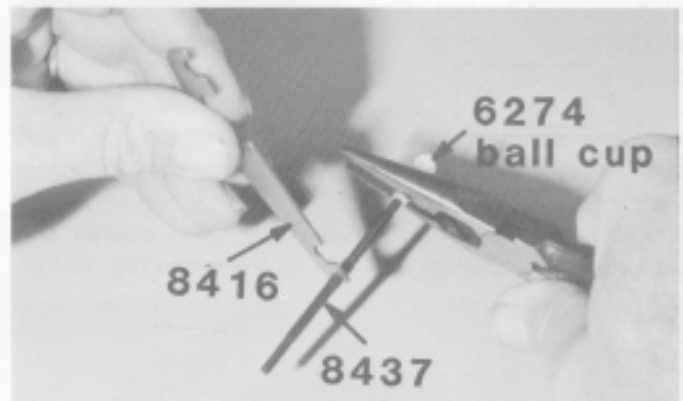

Fig. 83

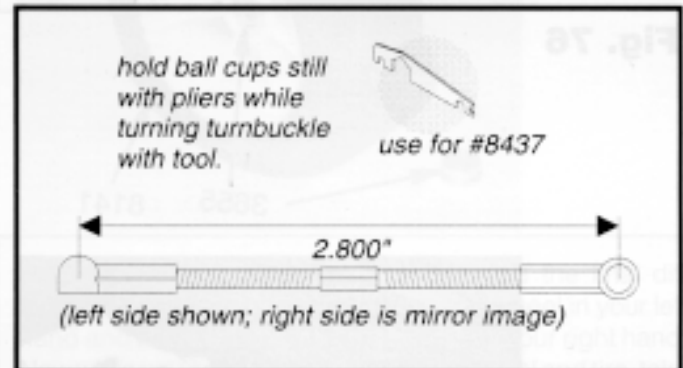

Fig. 83A

□ **Figs. 84, 85 & 86** (1) Now find the horizontal centerline of the front of the car and mark it on the chassis with a pencil (fig. 84). (2) Now take the assembled turnbuckles and snap them onto the steering block and servo saver ball ends as shown (fig. 85). (Remember there is a left and a right side turnbuckle.) (3) Align the center of the servo saver output shaft over the centerline drawn on the chassis. Make sure the turnbuckles are angled back slightly as shown in fig. 85. (4) We now need to mark the chassis to find the centers of both servo mounting blocks. Mark the front and back as well as both sides of each servo mounting block, but make sure the servo mounting blocks are both the same distance from the front of the chassis while the output shaft is over the centerline (fig. 86).

-  #6919 4-40 x 5/16
-  #6292 4-40 x 3/8

Fig. 86

(5) Now that we have the centers marked for each mounting block, drill the chassis using a #34 drill bit (a 1/8" bit will work if used carefully). (6) We include screws for both countersunk and non-countersunk holes. If you DO NOT want to countersink the holes, use two #6919 4-40 x 5/16" BHSScrews in bag 2. If you DO decide to countersink the holes, use a standard 82° countersink. For the countersunk holes we have included two #6292 4-40 x 3/8" FHSScrews, in bag 2, for you to use. Your finished front suspension with steering servo installed should look like figs. 85 and 86.

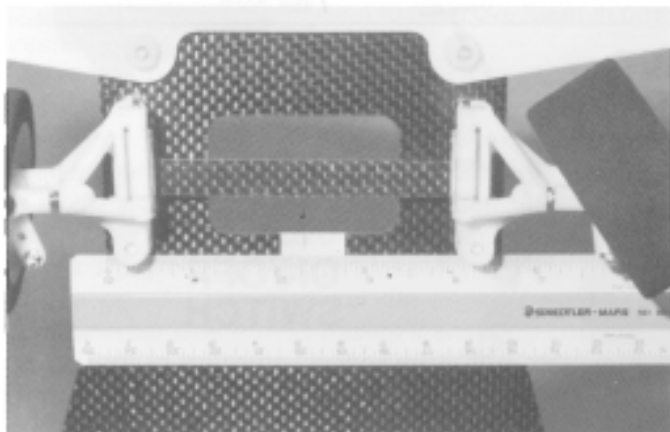
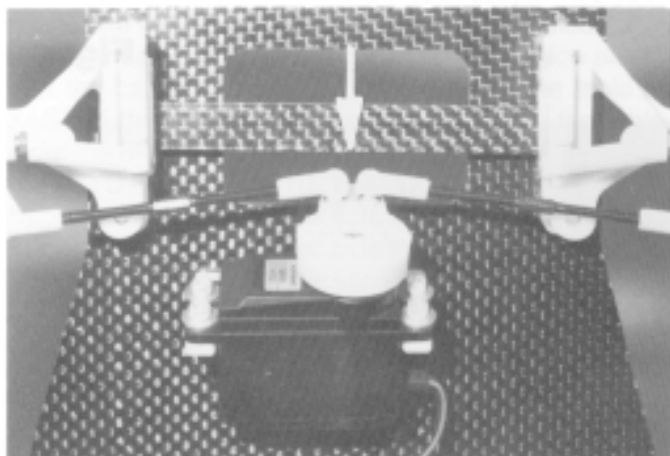

Fig. 84





 #6919 4-40 x 5/16
  #6292 4-40 x 3/8
 Fig. 85



Fig. 86

□ **Figs. 87, 88 & 89** Fig. 88 (next page) shows the layout of the batteries, speed control, receiver, steering servo, and the wiring of all electrical parts out of the chassis: This figure helps you visualize how all the different parts are connected, making the laying out of your electrical system easy. The parts used in the photos are Sanyo 1700 mah SCRC batteries, Novak HPC high frequency speed control, Novak three channel FM receiver, Airtronics 94102 standard servo, and a Reedy Mr. "A" modified motor.

Fig. 87 (this page) shows how the batteries are mounted to the chassis using fiber-reinforced strapping tape. The tape is run around the battery cells and the chassis, as shown in figs. 87 and 89.

Fig. 89 (next page) shows all the components installed on the chassis as laid out in fig. 88, with all connections functional. After all your connections have been made according to figs. 89, double check each connection before turning the car on. The photos show all battery and motor connections soldered into the car. This is the most efficient layout for serious racing, but there is nothing wrong with using connector plugs if your speed control came with them. Just pick up the correct mating plugs and connect them according to the instructions.

NOTE: Because of the many different designs and sizes of speed controls and receivers, we will not go into detail laying out all of the different components. Always go by the manufacturer's instructions for proper installation of receiver and/or speed control.

The important things to follow are to keep your battery and motor wires as short as possible (but without causing any binding) and to do your best to keep the antenna wire away from any battery or servo wires.

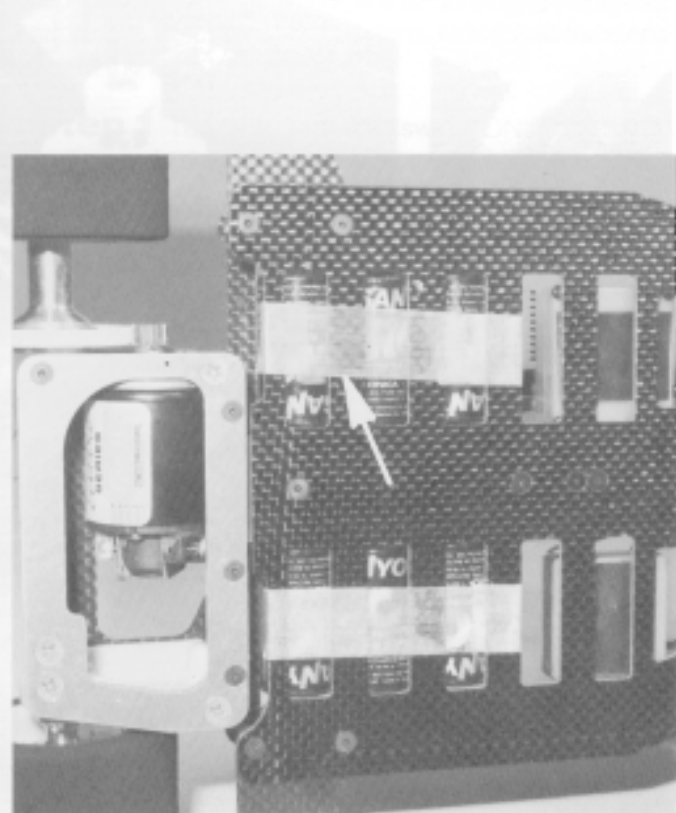
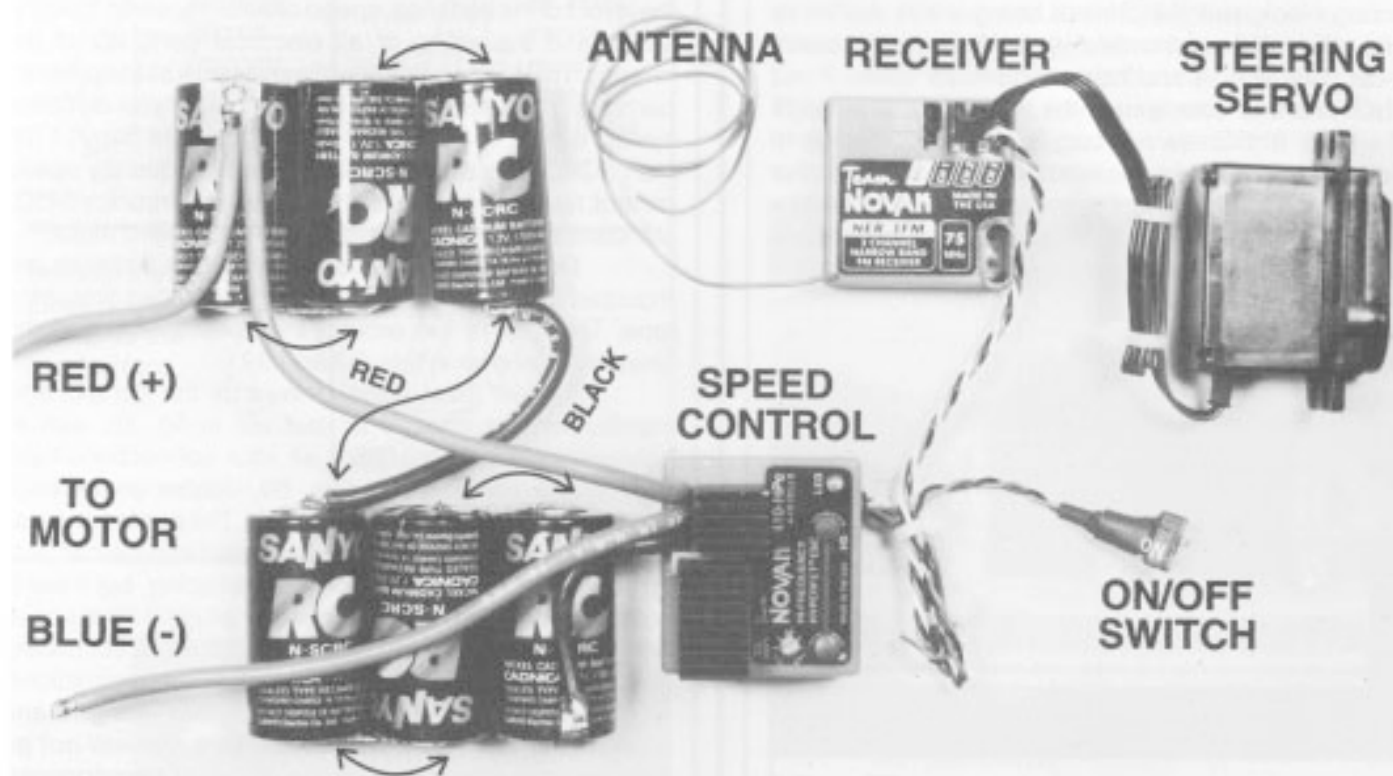

Fig. 87



 = solder battery ends here with battery strap braid in series (positive to negative).

Fig. 88

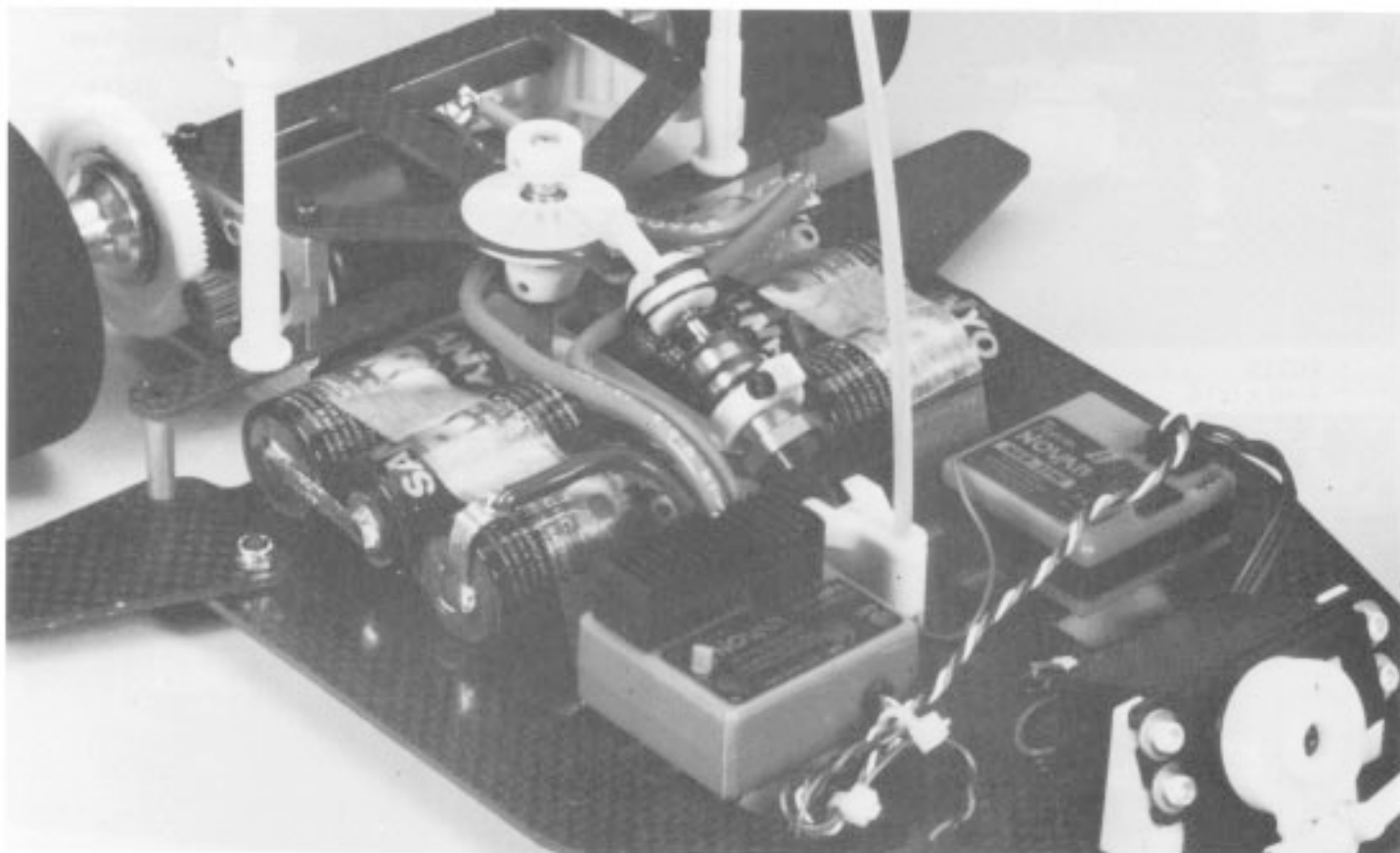

Fig. 89

Figs. 90 & 91 Now it is time to set the car "tweak". After EVERYTHING ELSE is installed on the car, including batteries, motor, speed-control, and all the radio equipment, we can set the "tweak".

TWEAK. What is tweak? It means the left front wheel should be pushing down on the ground with exactly the same amount of weight as the right front wheel. Likewise the left rear wheel should be pushing down on the ground with the exact same weight as the right rear wheel.

If this is not happening, the car is TWEAKED (or twisted). This will cause the car to spin out easily under acceleration; it will also cause it to have oversteer in one direction and understeer in the other.

TO CHECK THE TWEAK, take a ruler and measure from the outside of the left hand rear wheel to the outside of the right hand rear wheel (fig. 90). Now take exactly half of that amount and mark the exact centerline of the car on the #8202 aluminum lower brace. You can just scratch a mark on the bottom of the brace with an X-acto® knife.

Racers Tip: Team drivers will take a small drill bit and make a countersunk mark on the center point of the aluminum rear brace. This makes it easier to put the X-acto® blade in the same location every time they want to check the tweak.

Now place the car on a flat level table or surface. Take the X-acto® or hobby knife blade and put the edge of the blade underneath the bracket exactly where your mark is and very slowly lift up the car with the blade until the rear wheels are just off the ground (fig. 91). Now slowly lower the car. Both rear tires should touch the table at EXACTLY the same time. If one tire touches the table before the other tire, the car is tweaked.

TO CORRECT THE TWEAK, refer back to fig. 27 where we installed the tweak screws. Now **loosen** 1/8 turn the tweak screw on the tire side that touched **last**, then **tighten** 1/8 turn the tweak screw on the tire side that touched **first**. Recheck the tweak. Continue to make adjustments until both rear tires touch at EXACTLY the same time. When they do, then you have adjusted the tweak correctly. **Note:** Always loosen one screw before you tighten the other screw the same amount.

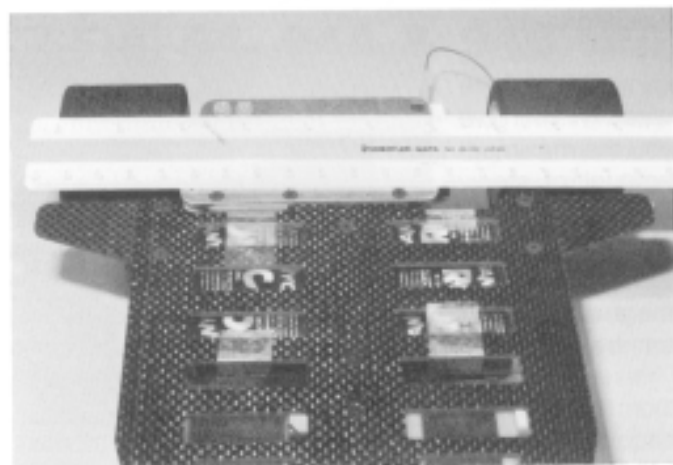

Fig. 90

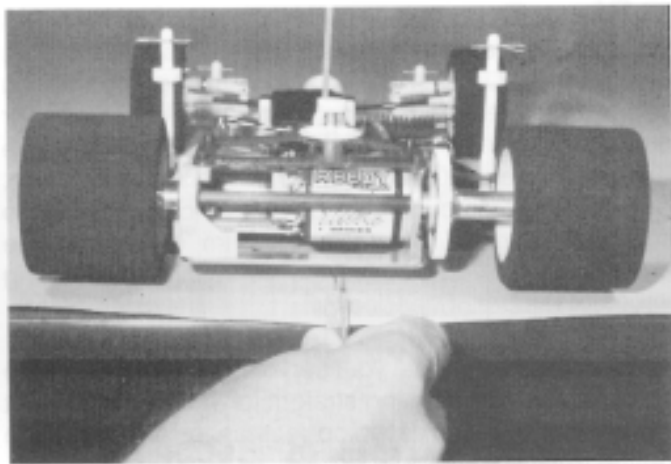

Fig. 91

FINAL ADJUSTMENTS

BATTERY CHARGING. Charge your transmitter batteries if they are Ni-Cads. This will require an overnight charge.

Next, charge your car's battery pack according to your charger manufacturer's recommendations. Make sure all the speed control connections are according to the speed control manufacturer's specifications. Now follow the steps below in the listed order.

Step 1 Turn the transmitter switch ON. Does it give you a good reading on the power meter? If it does, then go on to the next step. If the reading is low, let the batteries charge longer, or check the radio instruction manual for trouble-shooting instructions.

Step 2 If you are using plugs, unplug the motor connector. If the motor connections are soldered (referred to as "hard wiring"), then unsolder at least one of the connections. Make sure the unsoldered wire does not short out on the chassis or any other parts of the car.

Step 3 If your batteries have plugs, plug them into the speed control battery connector.

Step 4 Turn the car switch (this will normally be the speed control on/off switch) ON.

Step 5 Move the steering control (stick or wheel) to the right. See if the front wheels also turn to the right. If they turn to the left, you will have to move the steering servo reversing switch to its other position. Follow your radio system instructions on how to do this. Recheck to make sure both the radio and front wheels turn to the right.

❑ **Step 6** Now you need to check the centering on the steering servo saver. Is the servo saver pointing straight down? If not is it only a couple of degrees off? You can use the steering trim feature to trim the servo saver until it is centered. If the trim is off by more than a couple of degrees then you will need to remove the servo saver, center it, then remount it. Before you re-center the servo saver, remember to center the trim control on the transmitter. Now check out the centering again, using your trim feature, if needed.

❑ **Step 7** Now that your servo saver is centered, are your front wheels pointing straight forward? If not, adjust the steering turnbuckles to correct the problem and line up the front wheels.

❑ **Step 8** Now you need to set the speed control according to the speed control manufacturer's instructions. Most manufacturers now recommend doing adjustments with the motor disconnected, but if your manufacturer's recommendations are different, then you will need to turn the car switch off first and then the transmitter switch off. Reconnect the motor and turn the switches back on in the reverse order of how you turned them off. When you are done adjusting the speed control, you will need to reconnect the motor (if it is not already). Turn off the switches as specified above, connect the motor, then turn the switches back on.

❑ **Step 9** A word of caution before we start this step: make sure the car is sitting on a block or car stand so that the rear wheels cannot touch anything. Now recheck the speed control operation with the motor connected.

❑ **Step 10** When you are done setting the speed control and checking the motor, turn the car switch off.

❑ **Step 11** The transmitter switch must always be the **FIRST SWITCH TURNED ON** and the **LAST SWITCH TURNED OFF**.

YOUR CAR IS NOW READY TO RUN!

TUNING AND RACING TIPS

YOUR FRONT END

The new Dynamic Strut front end on your RC10LS gives you the ability to make fine-tuning adjustments much easier and quicker. This means you can try different settings in less time than before; you will have more time to attempt new combinations to fine tune the car. Many of the adjustments in this section are general and will apply to all radio controlled cars, while some are unique to only

a few. Try to be methodical when making adjustments and keep notes. Remember it is normal to have a slightly different setup for each track you drive on.

An important point to keep in mind when making adjustments to your car: you rarely get something for nothing. When you gain on one characteristic you will normally sacrifice on another characteristic, to some extent. The trick is learning to balance the gains in relation to the losses.

You have several different adjustments on your RC10LS, some of which can be used to tune the car for different track conditions.

❑ **Figs. 92 & 92A** **CAMBER** is a word describing the angle at which the tire and wheel rides relative to the ground when looked at from the front or back (figs. 89 & 89A). This is one of the most important adjustments on the car. Negative camber means that the tire leans inward at the top, putting it closer to the centerline of the car than the bottom of the tire. Positive camber means just the opposite, the top of the tire is further away from the centerline of the car than the bottom of the tire.

Negative camber will take away traction but increase stability. Positive camber will also take away traction but decrease stability. A tire's maximum traction is achieved when it is perpendicular to the ground (straight up and down).

We suggest a starting point of 0° or 1° of negative camber. This can be adjusted by turning the upper arm turnbuckle in the appropriate direction.

After driving the car, check and see if your front tires are wearing flat. If they are not, adjust the camber for flat tire wear. This will give you the maximum amount of steering. If slightly less steering is desired, add 1° or 2° more of negative camber.

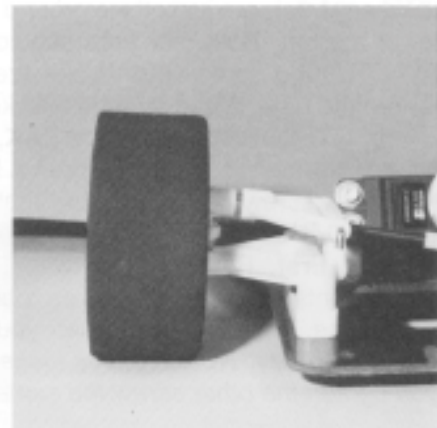

negative camber

Fig. 92

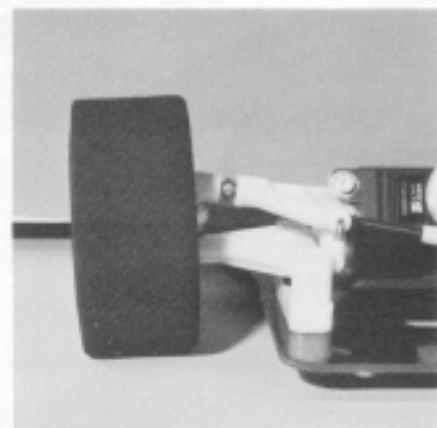

positive camber

Fig. 92A

□ Fig. 93, 93A & 93B CASTER

describes the angle of the kingpin, in relation to the vertical plane, when looked at from the side of the car. As an example, 0° of caster puts the kingpin in a vertical line. Positive caster means the kingpin leans rearward at the top.

Caster has several effects. The easiest way to see its effects is to compare it to the casters on the bottom of a shopping cart. When the cart is pushed forward, any misalignment of the casters will cause a side load on the wheels and thus cause the wheels to realign in the direction of travel.

Increasing the positive caster on your car will increase the steering turning into a corner and slightly increase understeer coming out of the corner. Reducing the positive caster (0°) will decrease the amount of steering you have going into a corner and increase the amount of steering you have in the middle of and exiting the same corner.

Caster is adjustable in increments of 2° by moving the small teflon shims as shown in the following three diagrams:

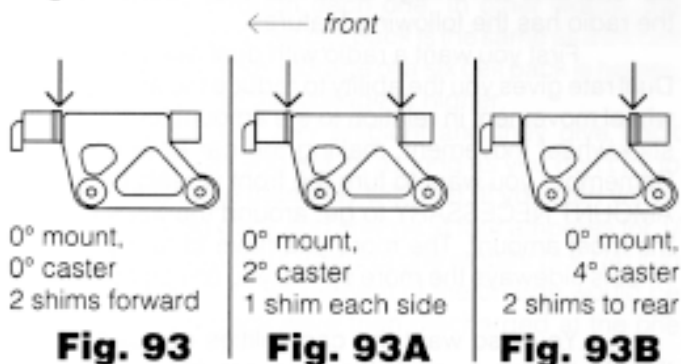

□ Fig. 94, 94A & 94B CASTER

CHANGE is relatively new to the R/C industry and is also an important adjustment possible with the new front suspension. There are two types of upper arm mounts. One has no angle change, when mounted (fig. 93) in relation to the lower suspension arm, and the other has a 10° angle, when mounted (fig. 94) in relation to the lower suspension arm. This angle provides caster change during suspension movement. The caster will change 2° during full suspension travel. Your car will steer more aggressively when using this option. Static caster is changed in the same manner as the zero angle arm mount (see figs. 94, 94A, & 94B). We suggest using this option only for road course applications (not oval), and only if an aggressive steering feel is desired.

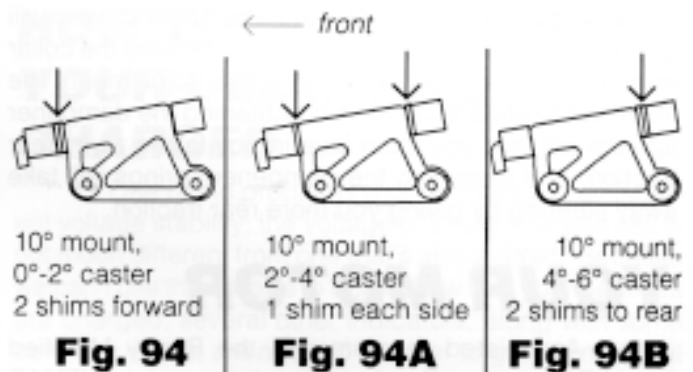

□ Figs. 95 & 95A TOE-IN AND TOE

OUT is a very helpful adjustment. Adding toe-in to the front tires helps stabilize your car under acceleration, but at the same time it removes a small amount of turn-in steering. Toe-out will allow the car to turn quicker in to a corner, but will reduce stability exiting the corners and going over bumps. Both toe-in and toe-out will scrub speed so try to use as little as possible of either.

Toe-in can be changed by adjusting the steering tie-rod turnbuckles.

FRONT SUSPENSION SPRINGS are available in four different wire sizes. They are: #8427 (.018); #8429 (.020); #8431 (.022 kit); #8433 (.024).

In general, a softer spring will provide more steering and a firmer spring will decrease steering. Oval racing will usually require a slightly firmer spring than road course racing.

Fig. 95

toe in

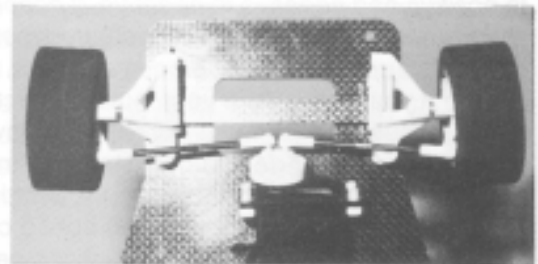
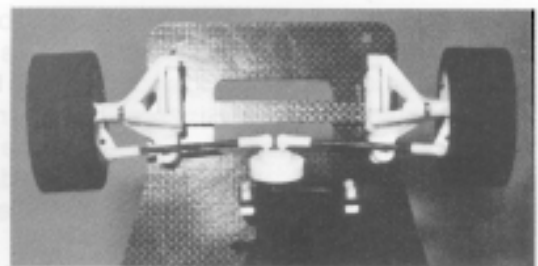

Fig. 95A

toe out



REAR DAMPENER ADJUSTMENTS

The rear dampener is a very important part of the car's overall handling. You want to keep the spring tension on the rear dampener washers as light as possible; this will help keep the back of the car moving freely. You also want equal pressure or spacing on both the

upper and lower spring. Many of the Team drivers will shave down the lower locking collar or replace the collar with washers to be able to make this adjustment. The main rule to understand is that tightening the dampener springs will give you more steering by taking away rear traction, and loosening the dampener springs will take away steering by giving you more rear traction.

YOUR MOTOR

Associated recommends the Reedy Modified line of R/C motors. Reedy motors have won ten IFMAR World Championships. No other motor manufacturers have come close to this record. Check your 1/10 scale catalogs for the various types of motors available.

A new development for motors and speed controls is an add-on device called a SCHOTTKY diode. This diode is being used by many speed control and motor manufacturers to improve the performance of both components. The diode is supposed to keep the braking MOSFETs cooler to improve your braking performance and reliability, help prevent integrated circuit lockup (which can occur with some of the new higher-performance motors used with high frequency speed controls), and improve the regeneration ability of the speed control. The diode, by reducing the high voltage spikes that could reach your speed control, will reduce wear and tear on your speed control, which would then in turn reduce wear and tear on your motor. Reedy Modifieds sells these diodes (#745) which contains two diodes. **Caution:** *The diodes are polarized, so make sure that you hook positive to positive and negative to negative. If connected backwards, the car will act like it has a shorted motor when the throttle is applied until the diodes short out.*

If you take care of your motor correctly, it will not only last much longer but it will run faster over a longer span of time. Never deliberately stall your motor. If your car is stuck in the wall, do not punch the throttle; you could end up burning out your motor and speed control.

The following helpful instructions came directly from a Reedy Modified Motor Maintenance instruction sheet: Between runs, inspect the brushes to insure they are moving freely in the brush holder. This is done by carefully removing the spring and sliding the brush in and out of the holder. If there is any resistance or rough spots, remove the brush and carefully clean the brush with "Reedy-in-a-Can" Power Spray (Associated #750). This will clean off any build-up and lubricate the brush so it slides smoothly in the brush holder.

After every 3 to 5 runs, remove the brushes from the holders and inspect the tips for wear and/or burning. If there is a noticeable amount of wear, replace the brush with a new pair. To inspect for a burnt tip, look at the side of the brush on the contact end. If it appears a burnt blue color, then the lubricant in the brush has been burnt away and new brushes should be installed. These steps are important, for worn or burnt brushes can cause irreparable damage to the commutator.

After 2 or 3 runs you should carefully clean the motor. One recommended method is to connect the motor to an old battery pack and while it is running, spray a motor cleaner such as "Reedy-in-a-Can" Motor Cleaner (Associated #751) directly on the brush commutator area. Run the motor for approximately 15 seconds and apply the spray several times for 2 to 3 seconds. Disconnect the motor and spray again, making sure the run-off is clear and clean. If the run-off is still dirty, repeat the spraying action until clean. After completing the cleaning, apply a small amount of lightweight oil on the bushing or bearing for lubrication. Be careful not to apply too much oil, for this will pick up dirt and contaminate the commutator and brushes.

Never overgear your car (large pinion and/or spur gear). Overgearing can cause excess heat and can damage the motor.

YOUR RADIO

Your car will work with any standard 2 channel surface radio system but you will find it easier to adjust the car and take advantage of its maximum performance if the radio has the following features.

First you want a radio with dual rate capabilities. Dual rate gives you the ability to reduce the amount of car wheel movement in relation to the amount for transmitter stick/wheel movement, making the car easier to drive. Remember you want to turn the front wheels the LEAST AMOUNT NECESSARY to get around the track fast, not the most amount. The more you have to turn your front wheels sideways the more speed you are going to scrub off.

You also want the capabilities of adjusting the throttle trigger or stick for a seventy/thirty ratio. This means you can adjust the throttle so that 70 percent of the entire travel is used for forward throttle and thirty percent is used for braking.

YOUR BATTERY CHARGER

Almost all of the current quick chargers on the market do the same thing—supply a charging current of about three to six amperes. They differ in the power source they use (either 12 volts D.C. or 115 volts A.C.) and in additional features. Your basic charger is normally an AC/DC timer charger. If you are racing some of the new features like constant current charging, pulse charging, or voltage peak detection may be beneficial. Naturally the more features the more expensive the charger becomes. For serious racing we recommend Novak or Tekin automatic battery chargers but there are other good manufacturers on the market now.

YOUR NI-CAD BATTERIES

It is important to understand the characteristics of the battery pack in your car, because how you use it will greatly affect both its performance and its life. With proper care your pack will give you top performance for hundreds of cycles.

For 1/10 scale racing the R.O.A.R. (Radio Operated Auto Racing) or N.O.R.R.C.A. (National Organization for Racing Radio Control Automobiles) legal battery is composed of either four or six "sub-C" size cells with a maximum rated capacity of 1.7 amp/hrs. This means that the cell will supply 1.7 amperes one hour, or .85 amperes for two hours, etc. This capacity rating drops to about 1.5 amp/hrs at high drain rates. For instance, at twelve amperes (a typical average current drain for a 1:12 scale modified electric car) the cells would discharge in 1/7 of an hour (just over eight minutes). This charge capacity is the same regardless of the number of cells in the pack because the cells are connected in series and the same current passes through each one. In other words, the charge capacity of a four cell pack is the same as a six cell pack. The total energy storage of a six cell pack is higher, of course, because the voltage is higher.

Ni-Cads are very efficient and they give back almost as much as you put in, as long as you don't try to put in more charge than they will hold. If you start with a completely dead pack and charge at four amperes for 1/4 hour, you will have put a total of one amp/hr ($4 \times 1/4$) into the cells. More than 95 percent of the charge would be recovered if the pack were then discharged at the one hour rate.

HOW TO TELL WHEN YOUR CELLS ARE CHARGED

One of the problems with Ni-Cads is their inherent voltage stability; the voltage of a fully charged cell is not much different from one that's about dead. Because we can't use the voltage to detect how well your batteries are charged, several other indicators, along with some common sense, are needed in order to get the most out of your batteries. The following is a list of indicators you should use to detect full charge.

TEMPERATURE METHOD This works only if you start with a cool battery pack. As the pack charges, frequently check its temperature by feeling the cells directly. As soon as you notice an increase in temperature, stop charging. If the cells become too hot to hold onto, your cells are overcharged. Let them cool.

TIME CHARGE METHOD This works only if you have confidence in the timing accuracy of your charger. Many chargers on the market only approximate a constant charging current; they may vary from six amps when you first start charging, all the way down to two amps if the Ni-Cad pack is nearly charged and the voltage of the charging source is low. If the charging current varies, it becomes difficult to estimate the average current. However, if your charger is reasonably dependable, you can use the following method.

Cycle your pack several times using the "temperature method" above. After you run the car the last time, let the pack cool. Charge again using the temperature method, but this time keep track of the time required to reach full charge. Once you have established the time, you can use it as a setting for the timer on your charger. To be safe use a setting about one minute less than what you established. This method allows you to charge without constantly monitoring the battery temperature.

CELL-CHARGING SUMMARY:

Method	Procedure
Temperature	Feel the cells by hand periodically while charging; at increase of temperature, stop charging.
Timed Charge	Charge several times as in Temperature method above, keeping track of time you stopped charging. Set charger to that time, minus one minute.
Voltage	Connect digital voltmeter across terminals of Ni-cads or throttle control resistor when pack is less than half charged. Start charging and don't change it's rate. Stop charging at point when rapid voltage climb stops and begins to slow.
Slow Charge	Charge at between 0.05 and 0.12 amperes 15 to 40 hours for full charge, depending on your charger.
Full Discharge	Discharge overnight with a clip-on resistor before charging.
Topping-Up	Charge the last minute or two of your charge time just before the race starts.

If you charge a battery that is still hot from running, reduce the time about 20 percent. Then, after the pack has cooled, finish charging with the temperature method.

VOLTAGE METHOD

As mentioned earlier, voltage is a poor indication of a cell's state of charge. The change in voltage from 10% charged to 100% charged is usually less than 0.1 volt per cell. In fact, other factors like temperature, current drain, and "cell memory" have a greater effect on voltage than the state of charge does. However, if current flow and temperature are held constant, it is possible to see the cell voltage gradually climb during the charging process. The absolute value of this voltage isn't of much use; how the voltage changes is an excellent indicator.

To use this method, you will need a digital voltmeter or an expanded scale voltmeter capable of resolving 0.01 volts on the 10 volt range. Connect the voltmeter across the Ni-Cad pack, preferably right at the cell terminals, or, if that is not possible, across the speed control battery lead pins. Don't try to read the voltage at the output of the charger because you'll end up reading the voltage drop through all the connectors and cables between the charger and the Ni-Cad pack, which can sometimes distort the effect you're looking for.

You should start with a Ni-Cad pack that is less than half charged. Connect your charger and begin charging at four amps. If your charger is adjustable, set the current now; do not try and change it later. A constant current charger is preferable here, but if yours gradually drops off during charge, that's still permissible, as long as it doesn't drop below three amps.

Watch the voltage as the pack charges. Notice that the voltage at first climbs rapidly and in the middle of the charging cycle more slowly. This voltage will most likely be in the range of 8.5 to 10 volts for a six cell pack. As the pack approaches full charge, the voltage will begin to climb more rapidly; and as it goes into overcharge, the climb will slow down and then stop. Stop charging at the point where the voltage stops climbing. If you left the charger on, the voltage would begin to fall as the pack went deeply into overcharge and started to heat up. The maximum voltage reached will probably be in the nine to ten volt region; the actual value is unimportant.

Do not try to use a conventional voltmeter. Even a good quality VOM with a large, taunt-band, mirrored-scale meter movement is not adequate; by the time you could see that the voltage has stopped rising, it would be too late.

SLOW CHARGE METHOD Slow or "overnight" charging is a method you are not likely to use very often. However, it is a good way to bring the pack to absolutely full charge. The charging current must be between 0.05 and 0.12 amperes. If less current, the pack will never reach full charge; any more and the pack will overheat. The time required to reach full charge ranges from 15 to 40 hours depending on the current used. The charger can be left on for a much longer time without harming the

cells; however, the output voltage of the pack will be temporarily lowered by an extremely long overcharge. The voltage returns to normal after a discharge\charge cycle.

GETTING MAXIMUM VOLTAGE TO THE MOTOR

The tips that follow are really for the benefit of the serious racers, since these tips deal with factors that influence the voltage and available power of a Ni-Cad pack. We're talking about a difference of maybe 15 percent at the most, so if you're just out having fun, don't worry about it. Instead, skip ahead to the body section. The output of a fully charged pack can vary considerably, depending on the temperature and recent activity of the pack. These effects are listed below.

HIGH TEMPERATURE contributes its bad effects by lowering the output voltage under load. Less voltage means less speed. At normal 130° Fahrenheit, the voltage of a six cell pack can be almost a volt less than normal. Since a lot of heat is produced in the pack while the car is running, it's important to allow air to circulate around the batteries to keep them cool. Therefore, before the start of a race, keep your car out of the sun and off the hot asphalt.

MEMORY can also affect the output voltage. The first memory effect is caused by overcharging. The cells "remember" that they were overcharged and put out less voltage near the end of the discharge cycle. This is particularly noticeable if the pack is slow-charged for too long a time.

The second memory effect is caused by repeatedly not using up all of the battery's stored charge before recharging. The cells "remember" that they were not fully used and let the voltage drop off about one volt at the point where discharge usually stops. An example would be where you run a series of five minute heats, recharging between each heat, and then try to run an eight minute heat. The battery voltage will be low for the last three minutes of the race. The cure is to fully discharge the pack before recharging. "Full discharge" means the point where the first cell goes dead. Never discharge beyond that point.

The third memory effect is the "topping-up" effect of recent charging. The cells remember that they were recently charged and will produce a little more voltage early in the discharge cycle. Racers take advantage of this by putting the last minute or two of charge into their pack just before the race starts.

YOUR TIRES

The Associated RC10L series car has been one of the most dominant vehicles in the country. In the following we will explain some of the characteristics of a little-discussed factor for Associated's RC10L championship winnings: its tires. This section supplements the information given on page 4 in our *Tires & Wheels* catalog. These tips can help you choose the best tire for your application, whether for play or racing.

FRONT TIRES

#8130, \$4.50 pair, unmounted

Green-rated compound. Domestic foam rubber. This is the most common compound used by any tire or car manufacturer. It's commonly used for carpet racing or for more steering on asphalt. Will work with almost any type of liquid traction additive (sauce) for improved traction, but will slightly increase tire wear. Just over one inch wide.

#8131, \$4.50 pair, unmounted

Black rated compound. Domestic foam rubber. This is Associated's kit front tire compound. Our black compound is a little firmer than our green, but softer than a blue compound. We have found this to be an excellent compound for asphalt racing with good steering, but better wear than a green compound. Will work with almost any type of liquid traction additive (sauce) for improved traction, but will slightly increase tire wear. Just over one inch wide.

#8132, \$14.00 pair, unmounted

Atlantic Gomme M-104 compound. Imported foam rubber. This is our highest traction and longest wearing front tire compound. We have not found a compound to compare with this one for traction or wear. Works well on prepared or unprepared asphalt surfaces. May be too much steering for carpet racing. Some liquid traction additives will give this tire increased traction and steering, but with almost no increase in tire wear. Just over one inch wide.

#8133, \$7.00 pair, unmounted

Atlantic Gomme M-106 compound. Imported foam rubber. This compound is similar in characteristics and wear to an Ufra Black Dot compound. It has less traction and slightly higher wear characteristics than the M-104 compound, but considerably better wear and traction than the domestic foam rubbers. Works well on prepared or unprepared surfaces. Some liquid traction additives will give this tire increased traction and steering, but will only slightly increase tire wear. Just over one inch wide.

REAR TIRES

#8155, \$8.50 pair, unmounted

Green rated compound. Domestic foam rubber. This is Associated's kit rear tire compound. We have found this to be an excellent compound for both carpet and asphalt. Will work with almost any liquid traction additive (sauce) for improved traction, but with slightly higher tire wear. Two inches wide.

#8156, \$15.00 pair, unmounted

Atlantic Gomme M-800 compound. Imported foam rubber. This is our highest traction and longest wearing rear foam tire. We have not found a compound to compare with this one for traction or wear. Works well on prepared or unprepared asphalt surfaces. May be too much traction for a carpet track. Some liquid traction additives will give this tire increased traction and steering, but with almost no increase in tire wear. One and three quarters of an inch wide.

#8157, \$10.00 pair, unmounted

Atlantic Gomme M-1200 compound. Imported foam rubber. This compound is similar in characteristics and wear to an Ufra Black Dot compound. It has less traction and slightly higher wear characteristics than the M-800 compound, but considerably better wear and traction than the domestic foam rubbers. Works well on prepared or unprepared surfaces. Some liquid traction additives will give increased traction and steering, but will only slightly increase tire wear. Two inches wide.

TIRES SUMMARY:

Front tires	part #	type	applications
less traction ↑ ↓ more traction	8131	black	carpet & asphalt
	8130	green	carpet & asphalt
	8133	M-106	asphalt
	8132	M-104	asphalt
Rear tires	part #	type	applications
less traction ↑ ↓ more traction	8155	green 2" wide	carpet & asphalt
	8157	M-1200 2" wide	asphalt
	8156	M-800 1 3/4"	asphalt

YOUR BODY

SELECT and purchase your 1/10 scale on-road body from the many available on the market. The car's body design will influence the car's performance. Associated has many tough Lexan bodies designed for racing; see the Body section of the Associated catalog included with your kit.

MARK the body mount and antenna holes accurately by mounting the body before painting it.

CUT OUT the holes you marked as well as the body shape. The bottom edge of the body, when cut out, should be even with your chassis.

PAINT your body by masking off the inside of the body with regular automotive masking tape according to your paint scheme. Follow the tips that come with your Associated Lexan body. The best body paint to use is Pactra, available in almost all hobby stores.

YOUR WING

You probably won't need a wing if you run on carpet, but if you run on asphalt, try the car with and without a wing to see which works best on your track.

Good luck! We hope to see you at the race track!

SHOW YOUR STUFF! ORDER FORM



Mail orders to:
Associated Electrics, Inc.
3585 Cadillac Ave.
Costa Mesa, CA 92626 USA

NAME _____

ADDRESS _____

Total amount of order
(in US funds):

\$ _____

ORDERING INSTRUCTIONS

DO NOT SEND CASH. NO CREDIT CARD ORDERS ACCEPTED.

California residents add sales tax: 7.75% in Orange County, 6.25% elsewhere.

Add shipping fee of \$4.00 to all orders except Blue Label. Extra charge for faster Blue Label service.

C.O.D. fee is \$4.50 (C.O.D. = "Cash On Delivery": paying purchase price directly to shipper upon delivery instead of prepaying us.)

All international orders must be prepaid by Inter-national Money Order in U.S. funds.

SHIPPING CHARGES SUBJECT TO CHANGE WITHOUT NOTICE.

DECALS

All decals are Mylar peel-and-stick.

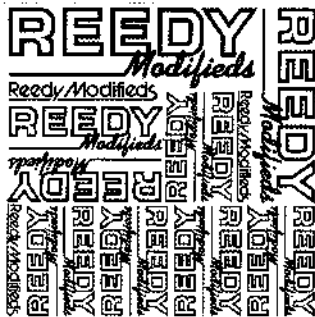

REEDY MODIFIED decals.
Several sizes, fluorescent pink.
712 2.00

REEDY MODIFIED decals.
Several sizes, blue.
713 2.00

REEDY MODIFIED decals.
Several sizes, red.
714 2.00

REEDY MODIFIED decals.
Several sizes, black.
715 1.50

REEDY MODIFIED decals.
Several sizes, white.
716 1.50



LARGE TEAM ASSOCIATED
decal. 7.5" length, black.
2812 5 logos 2.50

LARGE TEAM ASSOCIATED
decal. 7.5" length, white.
2813 5 logos 2.50

TEAM ASSOCIATED decals. 5"
length, black.
3818 6 logos 1.00

TEAM ASSOCIATED decals. 5"
length, white.
3819 6 logos 1.00



"RC10" DECALS. Fluorescent
red & yellow.
3807 2.00

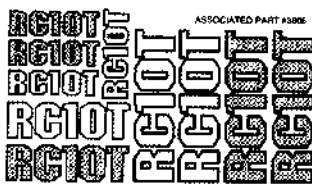

"RC10T" DECALS. Fluorescent
red & yellow.
3808 2.00



"RC12L" DECALS. Fluorescent
red & yellow.
3809 2.00



"RC10L" DECALS. Fluorescent
red & yellow.
3810 2.00



"RC10GT" DECALS.
Fluorescent red & yellow with
"GT" in white smoke.
3811 2.00



DECAL SHEET. 6 1/2" X 6 1/2",
5 colors; misc. sponsors.
6196 2.00

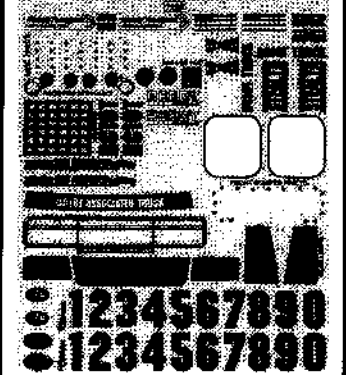

7195 SHOWN

RC10T TRUCK DECAL SHEET.
For the #6122 body.

7195 4.00

RC10T TEAM TRUCK DECAL
SHEET. For the #6130 body.
7196 4.00

RC10GT GAS TRUCK DECAL
SHEET. For the #6131 body.
7197 4.00

BUMPER STICKERS



TEAM ASSOCIATED BUMPER
STICKERS. 1 large, 1 small.

Red, white, blue.
3817 4.00

WHEEL DOTS

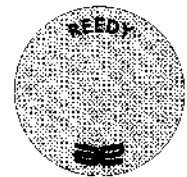

Mylar Wheel Dots are adhesive-
backed to cover the outside of
wheels. Fits buggy and truck
wheels. Can be reused.

WHEEL DOTS. Fluorescent
pink.
6855 4 Dots 2.00

WHEEL DOTS. Red.
6856 4 Dots 2.00

WHEEL DOTS. Green.
6857 4 Dots 2.00

WHEEL DOTS. Yellow.
6858 4 Dots 2.00

*non-standard discount item.

RC10LS

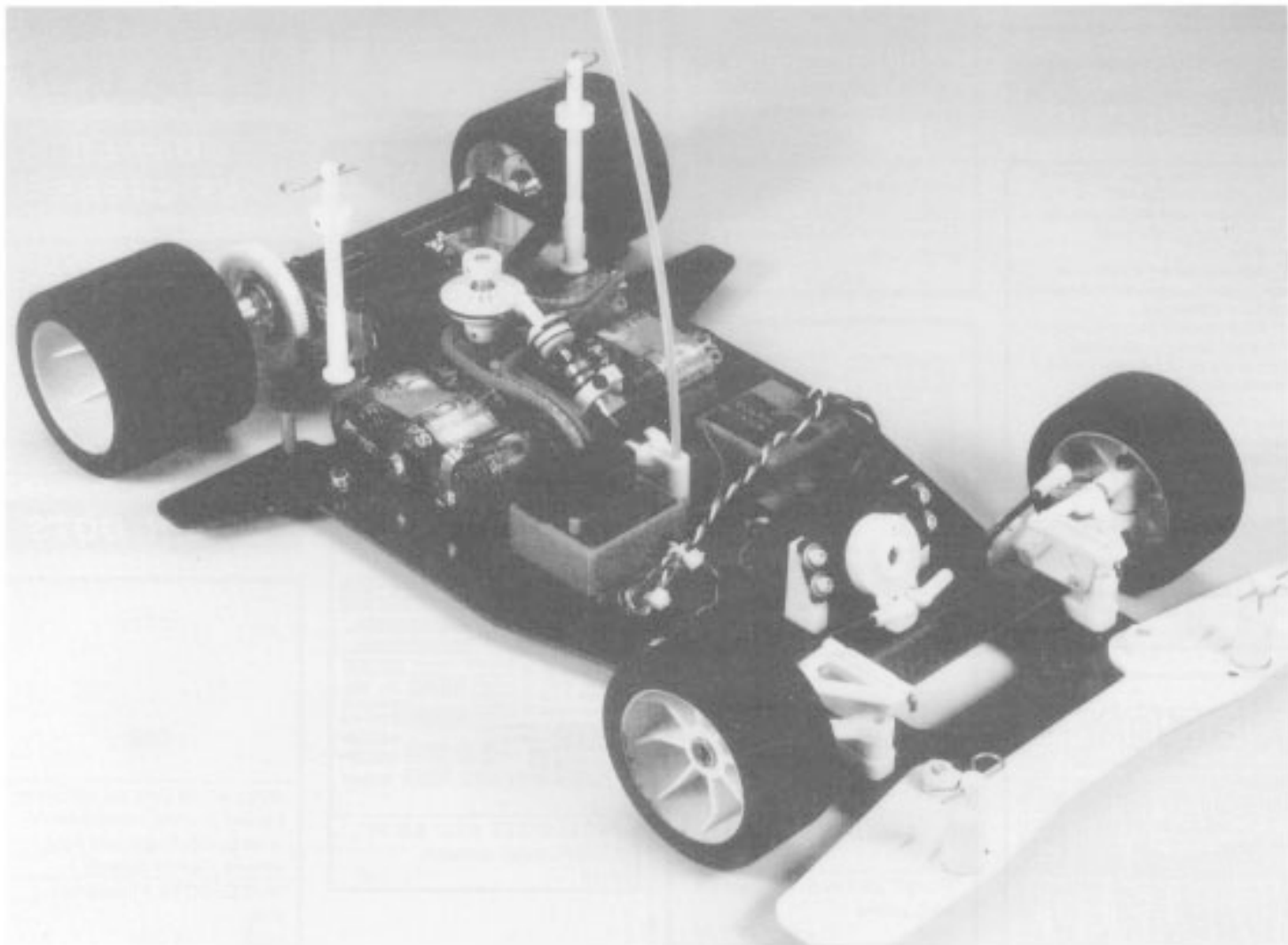

Associated Electrics, Inc.
3585 Cadillac Ave.
Costa Mesa, CA 92626

AE TEAM ASSOCIATED 