

FIRST, A WORD ABOUT THE NEW RC12LC

CONGRATULATIONS!! You have purchased the production version of the car that Masami Hirose used to win the 1996/97 IFMAR 1/12 scale On Road World Championships. This latest generation of the RC12L series car gives you more improvements and features to enhance your performance. Associated started in electric R/C with the original RC12E which won numerous National Championships. This progressed into the RC12I which won the very first 1982/83 1/12 scale IFMAR World Championships held in Anaheim, California. It then won the next 1984/85 IFMAR World Championships held in Denmark. The RC12L, the next generation, dominated the 1986/87 Las Vegas, Nevada World Championships by taking 1st through 5th as well as Top Qualifier honors. This car was again used to win the 1988/89 World Championships in Baarn, Holland.

For the 1990/91 World Championships, in Singapore, we redesigned the RC12L. The RC12LW as it was known, won the 1990/91 Worlds and backed that win up by winning the 1992/93 World Championships in Grand Rapids, Michigan. We then added our Dynamic Strut front suspension. This was given the name RC12LS. It was also the car to own until we won the 1996/97 Worlds with your new RC12LC. The designation RC12LC stands for **C**liff Lett who designed the car.

The proven features that come with the RC12LC include our Dynamic Strut front suspension (with our optional caster change feature), Delta shock, S2 rear axle assembly, and dished one piece wheels. The new rear axle allows you to change the right wheel without having to readjust the diff each time. To go with these successful features, Cliff Lett and the rest of our design team have relocated the dampener pivot post for more consistent performance. You also have dampener inserts to limit roll movement for quicker directional changes. We added a front suspension cross brace and used a new front suspension material. This makes the front suspension more rigid and more precise. The batteries were moved closer to the centerline, and a fiberglass roll over antenna was added to the new light weight antenna/shock mount. A new rear chassis brace and symmetrical T-bar were designed and a graphite T-bar brace was added. It also comes with a new precision lightweight left rear bulkhead for accurate bearing alignment. The redesigned upper and lower pod plates along with the left bulkhead make it easier to install, remove and solder in the motor. What you end up with is a car that is easier and faster to get dialed in to the track conditions. The 1996/97 IFMAR Worlds was the first race for the new 12LC. How did it fare? In the A-main the 12LC finished in the top five positions and took seven out of ten places. Your new car will show you why Associated has won all but one of the 1/12 IFMAR World Championships ever held!!

PLEASE READ THIS BEFORE YOU BEGIN

We feel that our instruction manuals are the best in the hobby. This is due to the number and quality of photos plus the written information that explains each assembly. While it is possible to assemble your kit only from the photos, we do not recommend this. There is important facts or tips in the written instructions that will help you to assemble your car for its best performance and to prevent any delays due to assembly errors. On road cars, while easier to assemble are more sensitive to improper adjustments. So if you want to make your car the best assembled car possible you will follow both the photos and written instructions.

STEP 1 Open each parts bag when the instructions indicate, not before. This is to help prevent parts from one bag getting mixed up with parts from another bag. This kind of mistake will cost you time and frustration while assembling your car.

STEP 2 Check each parts bag for supplementary instructions. Associated is always working on new designs and materials to improve our products. This means that we will occasionally make updates or changes to our kits. These changes cannot be made immediately to the manuals, so we use supplementary instructions to note changes. **1)** Inspect each bag upon opening it for the first time. Look for any pieces of paper than have part and drawings showing what is being changed. **2)** When you do find one, locate the section of the manual and parts list where these changes apply. **3)** Note the parts changes on the parts list then attach the supplement to the appropriate assembly step in the manual. This will help prevent delays in looking for the incorrect parts. It will also reduce the chance of losing time taking something apart that was assembled incorrectly due to use of the wrong parts.

STEP 3 Keep your parts separate. While building your car it will be necessary to have more than one parts bag open at a time. In order to prevent confusion we recommend using large paper plates (especially picnic plates with partitions) to keep parts from each bag spread out so that you can find them easily. Mark each plate with the bag number or description before you place the parts in them. When you have used all the parts from one bag. You can then re-label the plate so that it can be used for another bag.

STEP 4 Additional items needed to operate your car:

- 2 channel R/C, surface frequency, radio system (only one servo is required). Because of limited space a small size servo is recommended.
- Battery pack (6-cell) needs to be assembled into a saddle pack layout.
- Battery charger, (we recommend the use of a peak detection charger).
- Electronic Speed Control (also referred to as an ESC).
- R/C electric motor (will accept both stock and modified motors).
- Pinion Gear (48 pitch); size to be determined by type and wind of motor you will be using.

STEP 5 Tools. This kit contains the shock turnbuckle wrench and the three Allen wrenches you will need to assemble your car. In addition you will need to supply the following tools and supplies:

- #2 Phillips screwdriver (#SP-76).
- Needlenose pliers.
- Hobby knife, such as an X-acto knife with a #11 pointed blade.
- File (double cut, smooth is your best choice)
- Electrical tape, Associated #6312 clear chassis protective sheet or similar adhesive insulating material.
- #242 Blue Loctite or #271 Red Loctite
- Fiberglass reinforced strapping tape.
- Drill motor with a #43 (2.3mm) and a #34 (2.8mm) drill bits. If you cannot find these numbered drill bits you can use a 3/32" drill bit to replace the #43 bit and a 1/8" drill bit to replace the #34 bit.
- Soldering iron (40 to 50 watts, with a small amount of rosin (**not acid**) core 60/40 solder. We have found from experience that a pencil type soldering iron works better than the more common soldering guns. While the guns generate a lot of heat, they have a hard time keeping the heat at the tip.

Your kit can be assembled easier and faster with the following Associated tools or their equivalents:

- Allen drivers (straight Allen wrenches with hex shaped aluminum handles) such as the following Associated items:
 - #6957 .050"
 - #6958 1/16"
 - #6959 3/32"
 - #6591 2.5mm
- 3/16" nut driver will make installing the aluminum ball ends and small pattern 4-40 nuts easier and faster (#SP-86)
- 11/32" nut driver for adjusting the nylon diff nut on the rear axle.

WARNING! We **DO NOT** recommend the use of a power screwdriver to install screws into the nylon or composite parts. The rotation speed is too high causing the screws to heat up. This can cause the screws to break or the screw hole to strip out.

FINAL NOTES: (1) Experienced builders or racers: **please build the car according to the instructions first!!** The RC12LC setup came from our design team. What they have given you will be remarkably fast right out of the box for most track conditions. Start with the standard setup. This will give you a solid performance base to use for comparison for any changes you will then want to make. If you do not do this you will have no way of knowing if your changes will actually improve the cars performance. **(2)** At the beginning of each step you will find a box (□). When you have finished that step put a check mark in the box. When you stop for any reason during assembly it will be easier to find where you need to continue from.

(3) Occasionally an actual size drawing will accompany the photo to help you identify certain parts. You can place the part on top of the drawing to be sure you have picked up the correct part. Also you will most likely end up with a few extra fasteners or parts, so do not worry. **WARNING! Only the drawings at the bottom of the photos are true to scale.**

None of the photos are actual size. Even though you may see dimensions marked on the photos, the photos are still not to scale or actual size.

(4) The following types of special instructions, in *oblique* will be used throughout the manual:

Racer's Tip: This is a trick used by some of the Team Drivers to improve their car's handling, performance or maintenance.

Note: Alternate ways to assemble the kit, including tips for smoothing out difficult assemblies.

WARNING! This alerts you to be careful in order to prevent damaging the parts, and warns you against using wrong parts or doing an incorrect assembly that could damage or reduce the parts performance.

SAVE THIS MANUAL! This manual is more than an instruction manual. It is also a handy supplement to the Associated 1/12 scale catalog. You can use the manual photos to help identify part numbers and descriptions when ordering parts. *In addition, the manual can be used during a technical assistance call to our factory if you are having assembly problems or have any questions.* **Contact Customer Service at 714-850-9342.**

Please remember, it's not a race to see how fast you can put your car together, rather, it's how well you put your car together that will determine how well you race. **Please Take Your Time!**

Now clear off your work bench, line up some paper plates and let's start!

FRONT SUSPENSION ASSEMBLY

□ **Figs. 1 & 2** We now want to take out the #4504 .084" RC12LC Graphite chassis. Look at both sides of the chassis. The bottom will be the side with the countersunk holes. Before we can assemble the car we need to prepare the chassis by filing the battery slots. Use your file to bevel the battery slots on the top of the chassis (so that the edges are at an angle). This is done to prevent the battery cells from resting on a sharp edge which could cut through the battery sleeve (shrink wrap) and could cause the battery to short out on the chassis.

If you are going to only run four cell races you will only need to file the edges on the two back slots on each side of the chassis. If you are going to run six cell as well you will need to file three slots on each side of the chassis. The final step in preparing the battery slots will be to file the edges where the strapping tape, holding the batteries, touches the chassis. Just round the edges so they cannot cut the tape. Now dip a piece of #280 or #320 grit wet or dry sandpaper into some water to smooth all edges of the chassis.

WARNING! Graphite dust can be extremely harmful to your health. For proper safety make sure you are working in a well ventilated location. Use all proper safety precautions. When you have finished, wash off the chassis with running water and dry it with paper towels. Now wash your hands off with soap and cold water to remove the graphite dust. (Hot water will enlarge the pores of your skin and would allow the dust to get into your skin). Carefully

dispose of the graphite filings or dust.

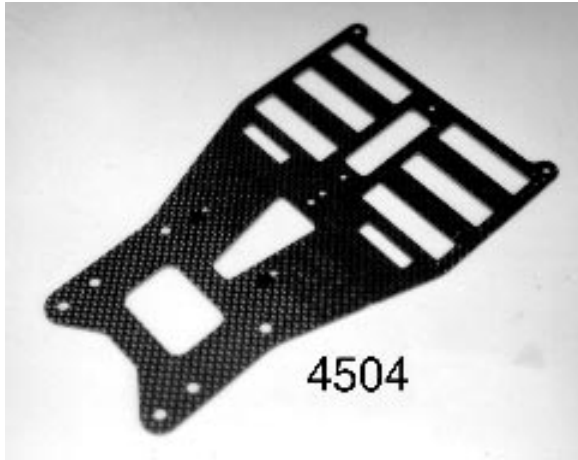

Fig. 1

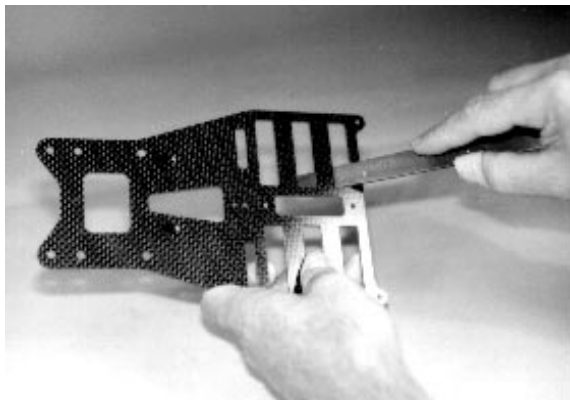

Fig. 2

Fig. 3 Because graphite conducts electricity somewhat like metal, we have to take some precautions. What we want to do is insulate the battery slots so the battery cells cannot short against the chassis. While the shrink wrap on each cell is an insulator, we still want to take extra precautions. We need to wrap the battery slot segments with electrical tape where the batteries will touch. **WARNING!** It is also important to make sure that none of the solder connections can touch the chassis anywhere on the car.

Racer's Tip: Team drivers will use a small piece of our #6312 clear chassis protective coating in place of the electrical tape. Cut a piece slightly larger than the battery area on each side of the chassis. Apply the adhesive coating over the battery area, cut out the slots, and then firmly smooth out any trapped air bubbles.



Fig. 3

Fig. 4 Before we start the assembly we need to locate the tools that come in your kit. Inside the Master kit bag you will find the #6950 tool bag. In this bag you will find three Allen wrenches. The information about each Allen wrench is indicated in the photo. Now open up bag #1. Inside you will find the #8416 gold colored shock/turnbuckle wrench. We will be using these supplied tools many times during the assembly of the kit.

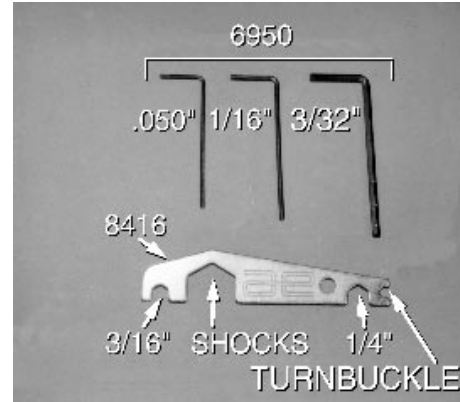

Fig. 4

Fig. 5 Go back to bag #1 and remove the #8407 front upper arm mount parts tree. There are two separate sets of mounts on the tree. Notice that one side of each mount has two "dome shapes" with holes drilled through the middle. Now locate the right side mount as shown in the photo. For road racing remove the 10° mounts. If you are going to try oval racing you will want to start with the 0° mounts.

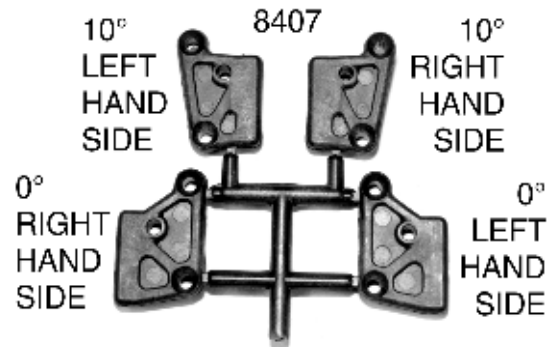

Fig. 5

Figs. 6, 7 & 8 From bag #1 remove the #8419 front lower suspension arms. These are normally connected by a molding runner. Also remove four #8409 4-40 x 1/2" aluminum shoulder FHMScrews. Go back to the #6950 tool bag we opened in fig. 4 and remove the 1/16" Allen wrench.

Start with the right hand side suspension assembly. To make sure you have the correct suspension arm, place the arm in front of you with the ball socket facing to the right. On the right arm the back arm mounting hole will have a slanted top surface.

Look at the back of the lower arm. You will see two recessed domes that will match up with the two domes on the

#8407 upper arm mounts. Place the upper arm mount against the lower arm so the domes interlock. Make sure that the slant is facing down and to the front as shown in the photo. Secure the mount to the arm with two #8409 4-40 aluminum screws. Go ahead and assemble the left arm and mount following the same steps. **Note:** be sure the Allen wrench is fully seated into the socket of the #8409 aluminum FHMScrew. If the Allen wrench is not all the way in it can cause the aluminum screw head to strip out before it is completely installed.

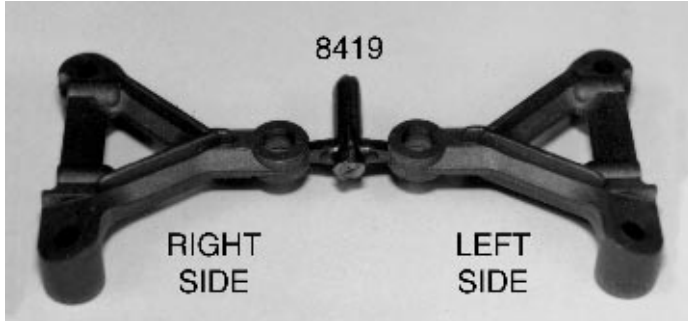

Fig. 6

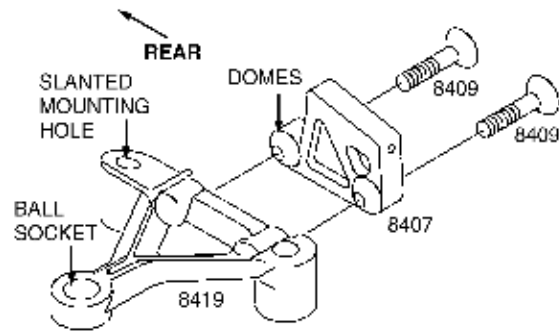

Fig. 7

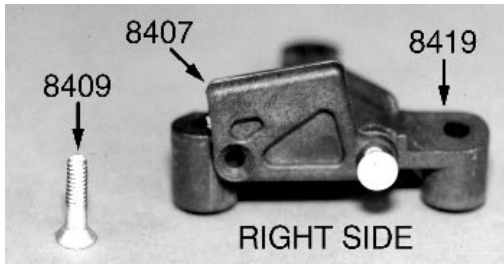

Fig. 8

Fig. 9 Also in bag #1 you will find a smaller bag containing the four #8417 plastic pivot balls. We will remove two for now. Look at the pivot ball. You will see that one side of the ball has a shoulder. Before we install the pivot balls look closely at the center hole from both sides. If you see any burrs remove them with a sharp X-acto knife.

To properly install the ball in the lower arm we want the shoulder facing up or on top. Place the pivot ball on the work bench then place the lower front arm over the pivot ball. Now snap the arm onto the ball using your thumb. This can take a fair amount of effort to accomplish, so you can also place a 1/4" nut driver on the arm over the pivot ball and then use your hand to

impact the tool until it snaps into place. **Note: always install the pivot balls from the bottom of the lower front arm. We do not recommend the use of pliers to install the pivot balls since they can cause the balls to deform.** Now go ahead and install the second pivot ball into the left lower front arm.

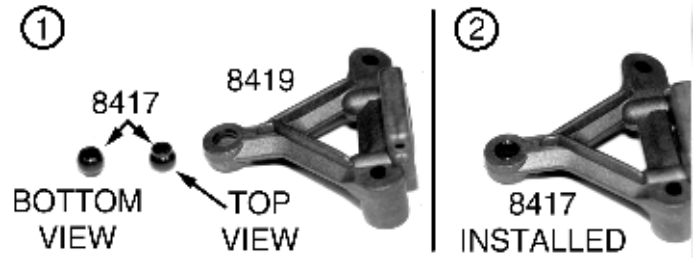

Fig. 9

Fig. 10 In bag #1 you will find four #8439 8-32 x 5/8" FHMScrews and four #3323 #8 thick aluminum flat washers. Line up the right arm assembly with the two matching holes on the right front of the chassis. Install two #8439 screws through the bottom of the chassis. Now place one #3323 aluminum washer over each screws on top of the chassis as shown. Use your #2 Phillips screwdriver to secure the arm to the chassis. Do not completely tighten the screws just yet. Now repeat the above steps to install the left arm assembly.

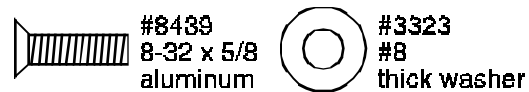
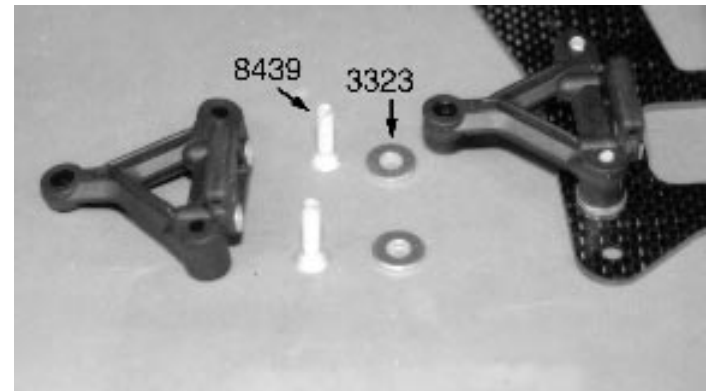
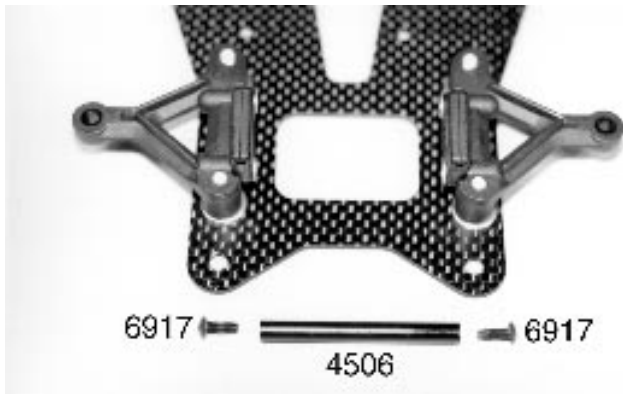

Fig. 10

Figs. 11 & 12 Still working with bag #1 remove the #4506 aluminum front suspension brace and two #6917 4-40 x 3/8" BHSScrews. Look closely at each of the upper arm mounts. You will find a hole in each mount just above where the mount attaches to the lower arm (see photo). Place the brace tube between the arm mounts. Line each end up with the hole in the mounts. Now secure the brace tube to the mounts using the two #6917 screws. Go ahead and tighten the screws. Go back to fig. 9 and tighten the four #8439 screws.



 #6917
4-40 x 3/8

Fig. 11

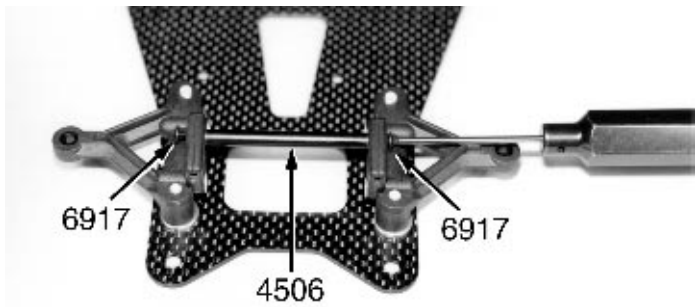
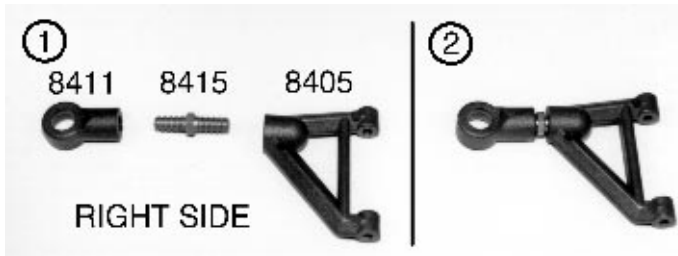

Fig. 12

Fig. 13 Remove two #8411 nylon upper arm eyelets, two #8415 upper arm turnbuckles, and two #8405 upper suspension arms. The upper suspension arms are the same until they have been assembled. We are still working with bag #1. Now we will start with the right side. Thread one of the #8411 nylon eyelets onto one end of the #8415 turnbuckle. Now hold the center section of the turnbuckle with the #8416 wrench. While holding the wrench, thread on one of the upper suspension arms until the threads bottom out.

The photo shows the right arm parts laid out and then correctly assembled. Look at the outer edge of the upper arm eyelet. On one side the outer edge is rounded and the other is more sharp or square edged. Make sure the square edge is facing down. Now assemble the left arm which will be a mirror image of the right arm but make sure the sharp or square edge of the eyelet is facing down as well.



 #8415
turnbuckle

Fig. 13

Figs. 14 & 15 Remove the two remaining #8417 plastic pivot balls. Place one of the balls on the work bench shoulder side down. Place the square edge side of the upper arm eyelet over the pivot ball. Again use your thumb to snap the eyelet onto the pivot ball. If you are having trouble doing this you can use your 1/4" nut driver to make the assembly easier. We do not recommend using pliers for this installation.

Now locate the two #8413 upper arm hinge pins and the small bag with the four #8413 PTFE caster shims that will be in bag #1. We are going to install the right upper suspension arm to the right arm mount. Make sure you have the right upper arm by checking the eyelet to see that the square edge side is down. Also make sure that the angled side of the arm is to the front. Slide the #8413 upper arm hinge pin through the upper arm and arm mount. Make sure one of the #8413 PTFE caster shims is installed on each side of the arm mount. Go ahead and install the left upper suspension arm. **Note:** Changing the location of the PTFE caster shims will give you different caster settings. See tuning section at the end of the manual for more details.



Fig. 14

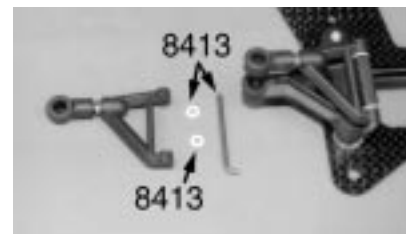
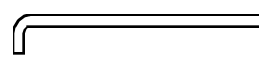



Fig. 15

 #8413  #8413
teflon shim

Figs. 16 & 17 Next we need the #8421 nylon steering blocks in bag #1. You will see a line molded into the steering block between the two holes. This is the top side of the steering block. The photo will show which is the right and left steering blocks. The steering blocks were designed to fit both our 1:12 and 1:10 scale cars. For the one 1:12 scale car we need to cut the steering block at the mold line as shown. After you have cut the steering blocks you will want to round the corners where you cut. You can use your file or sandpaper to accomplish this.

Also in bag #1 you will find the #4448 aluminum ball ends and the #4449 4-40 small aluminum locknuts. Remove two of each for this step. You will also need to remove the two #3213 front axles and two #6299 1/8" E-clips. The E-clips are held together by white tape. They are so small it is easier to look for the white tape than to look for the E-clips.

Thread one #4448 ball end into each steering block and then thread the #4449 4-40 small aluminum locknut onto the end of the ball end threads. We want the ball end on top and the nut on the bottom of the steering block.

Now take the #6299 E-clips and install one onto one end of each front axle. We can now push the axle into the steering block so the E-clip will be on the back side as shown.

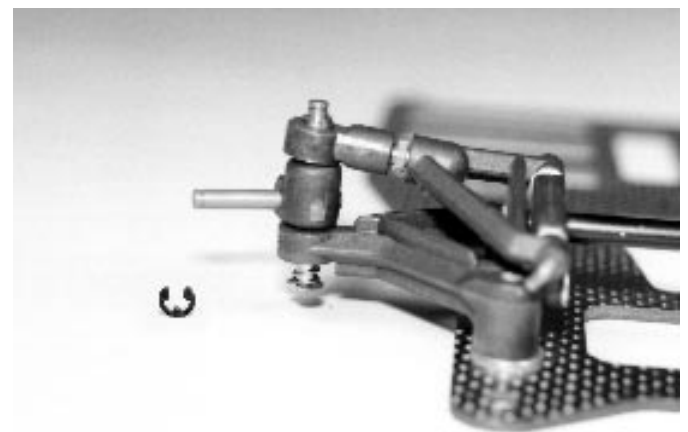
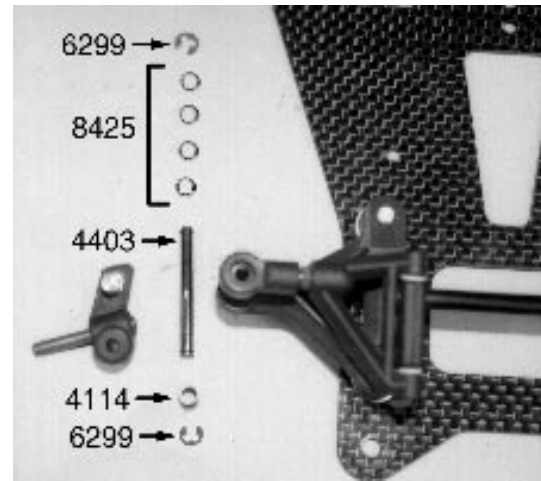
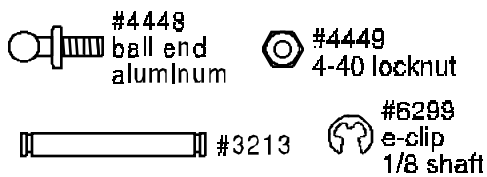
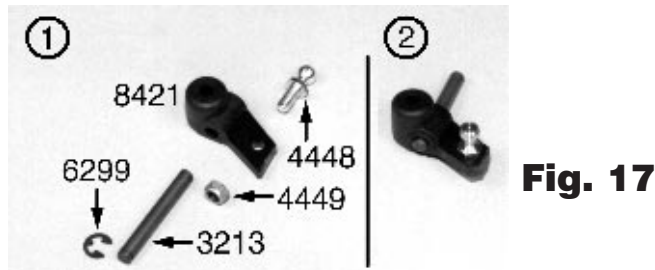
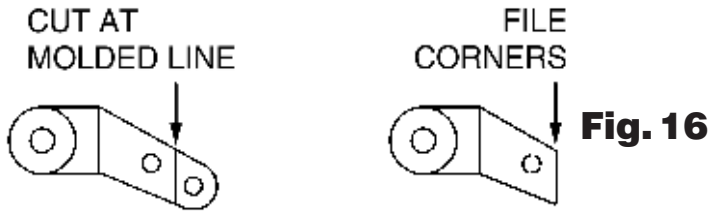

Fig. 18 & 19 Take out the two #4403 kingpins, two #4114 .018" springs, four #6299 1/8" E-clips, and the eight #8425 steel kingpin shims. All of these parts will also be in bag #1. First install one #6299 E-clip onto each #4403 kingpin. Next install one of the #4114 springs onto the kingpin and let it rest on the E-clip. We will start with the right side arm assembly and steering block. Push the kingpin up through the pivot ball in the lower front suspension arm. Install the kingpin from the bottom of the pivot arm. Now install the steering block onto the kingpin over the lower suspension arm. Check that the ball end is on top and the flat side of the steering block is on the bottom. Push the steering block down against the lower suspension arm pivot ball. Finally, align the kingpin with the pivot ball in the upper suspension arm and push it through.

Place four of the #8425 kingpin shims over the end of the kingpin on top of the upper arm pivot ball. Now secure the shims in place with another #6299 1/8" E-clip. Go back and repeat the process for the left assembly. **Note:** Check that the raised shoulder on both the upper and lower pivot balls are making contact with the steering block.

Fig. 20 Using your thumb, push down on the top of the kingpin so that any free play in the kingpin will be taken up on the spring side of the kingpin.



T-BAR ASSEMBLY

Fig. 21 Now we can open bag #2. Start by taking out the two #4335 plastic pivot sockets. There are two halves to each socket. Take one upper and lower portion of the pivot socket. This will become the front pivot socket. Look at the photo, you will see how much you must trim from each side of the two halves. We only have to do this for the front pivot socket.

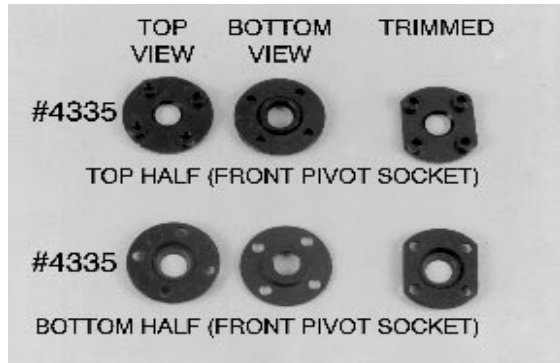
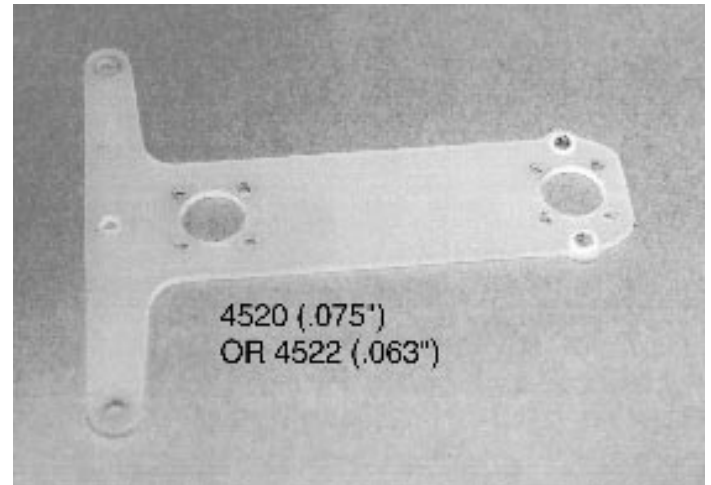

Fig. 21



#4334
2-56 x 5/16

#4336
steel pivot ball

Fig. 22

Figs. 22, 23 & 24 In bag #2 you will find one #4520 .075" fiberglass T-bar and one #4522 .063" fiberglass T-bar. The .075" and .063" refer to the thickness of the T-bar. If you are going to be racing on asphalt you will want to start with the #4522 .063" T-bar. If you are going to race on carpet we recommend starting with the #4520 .075" T-bar. There is no top or bottom on the T-bar until the pivot sockets have been installed.

Now remove two #4336 steel pivot balls and eight #4334 2-56 x 3/16" BHSScrews from the same bag. We will start with the front pivot socket assembly which we modified in fig. 21. Look at the lower half of the pivot socket. There is a raised portion that will match the hole on the front of the T-bar. Place the socket into the hole and line up the trimmed sides as shown. This will leave the tweak screw holes exposed. Now take one of the #4336 steel pivot balls and snap it into the center of the lower pivot socket. Place the upper portion over the steel pivot ball. Be sure to line up the trimmed sides on both halves. Holding the socket parts in place with your fingers, turn the T-bar and socket parts upside down. Now use your .050" Allen wrench from your tool bag and four of the #4334 2-56 screws to secure the socket to the T-bar. This will place the heads of the screws on the bottom of the T-bar and the socket and ball parts on top. **Note:** It is very important to make sure the Allen wrench is fully seated into the socket portion of the screw or they will strip out.

Now repeat the above assembly for the second pivot. For this pivot the ball must pivot freely in the socket while not being loose. If the ball is not pivoting freely, you can equally unscrews all four #4434 screws 1/8 to 1/4 turn. However the best way to make the ball pivot freely is to remove the pivot ball and polish it. You can do this by placing the ball on a long 4-40 screw and securing it with a 4-40 nut. You would then mount the screw in a drill press, hand drill, or a Dremel tool, then polish the ball with crocus cloth or 600 grit wet or dry and paper. Clean the ball off and reinstall it and check the movement. Keep doing this until the ball pivots freely, but is not loose.

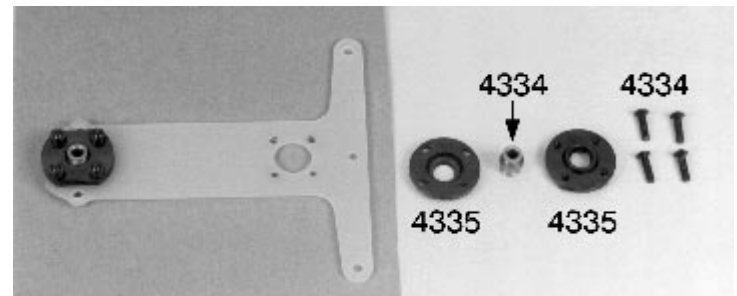

Fig. 23

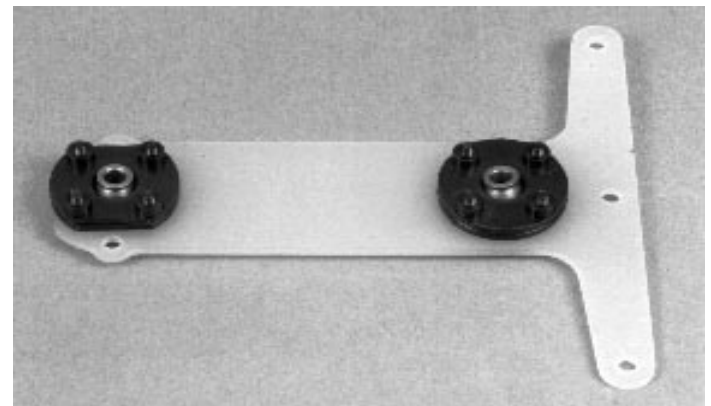

Fig. 24

Fig. 25 In the same bag you will find two #4436 4-40 x 5/16" socket set screws. Install the two set screws into the two holes next to the front pivot socket as shown. The holes for the set screws are not threaded so take your time when threading them in. You will again be using your .050" Allen wrench with these screws.

#4436
4-40 x 5/16
Allen screw

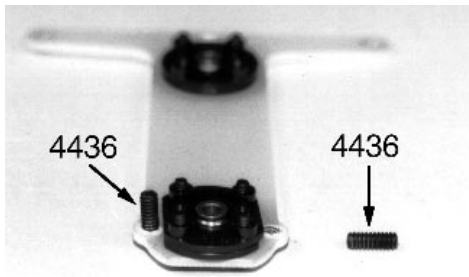

Fig. 25

Fig. 26 & 27 Still working with bag #2 remove the #4524 graphite T-bar brace, one #4519 4-40 x 9/16" FHSScrew, one #6915 4-40 x 5/8" FHSScrew, one #4449 4-40 small aluminum locknut, and the #4515 aluminum dampener center post. From the bottom of the chassis install the #4519 screw into the front T-bar mounting hole and the #6915 screws into the back T-bar mounting hole. Place the T-bar assembly over the two screws as shown. Now place the #4524 graphite T-bar brace over the two mounting screws. Thread the #4449 locknut onto the front mounting screw to secure the front T-bar pivot to the chassis. Now take the #4515 center post and thread it onto the #6915 screws coming up through the rear pivot ball. Go ahead and tighten both pivot balls against the chassis. **Note:** You may want to hold the #4515 aluminum center post with your needlenose pliers while you tighten the #6915 rear mounting screw.

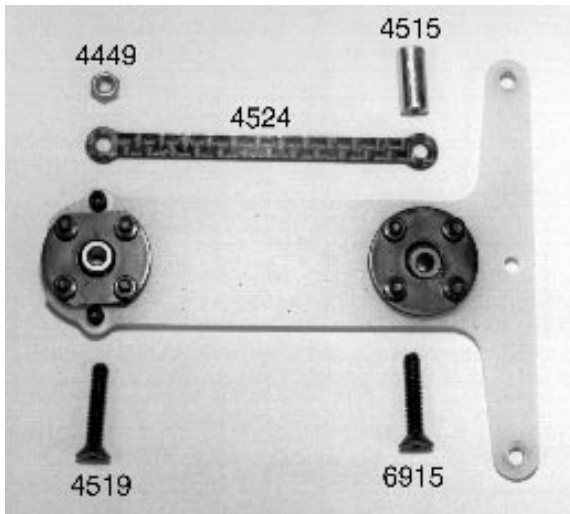

Fig. 26

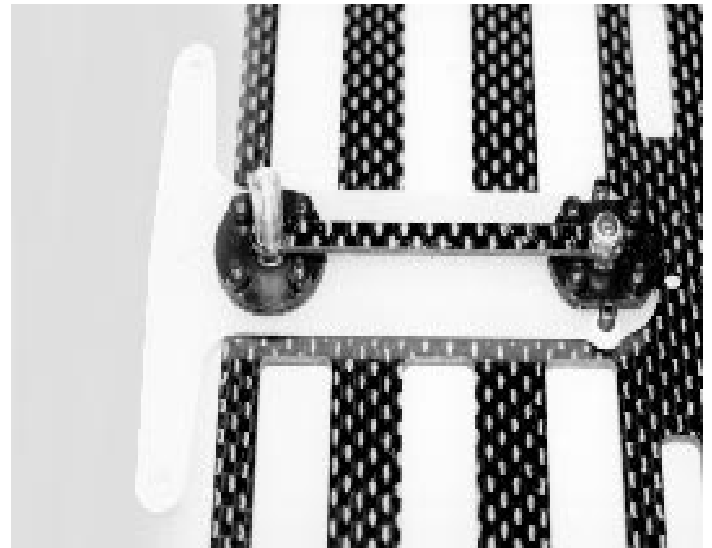
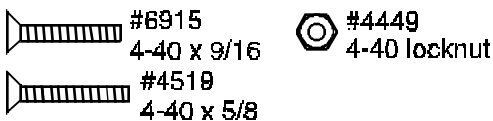

Fig. 27

REAR CHASSIS BRACE & DAMPENER ASSEMBLY

Fig. 28 Now find and open bag #3. Start by removing the two #4442 aluminum chassis brace standoffs and two #7673 4-40 x 5/16" FHSScrews. You will be using the two #7673 screws to secure the #4442 standoffs to the back corners of the chassis.

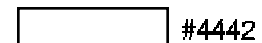
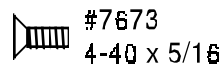

Fig. 28

Fig. 29, 30 & 31 Take out the #4534 graphite rear chassis brace. Also remove the #4516 plastic dampener post and one #6917 4-40 x 3/8" BHSScrew. Look at the chassis brace. There are two holes at the center area. One along the bar portion and the other on a small section protruding from the center. Secure the plastic dampener post to the hole in the bar portion of the brace using the #6917 screw. Use #242 Loctite to secure the damper post to the screw. This way it cannot come unthreaded when you remove the top screw in the post for normal maintenance or adjustments.

Now remove three #6917 4-40 x 5/16" BHSScrews from bag #3. Place the rear chassis brace on top of the three aluminum tubes as shown. Line up the three mounting holes and use the three #6917 4-40 x 5/16" BHSScrews to fasten the brace down to the tubes.

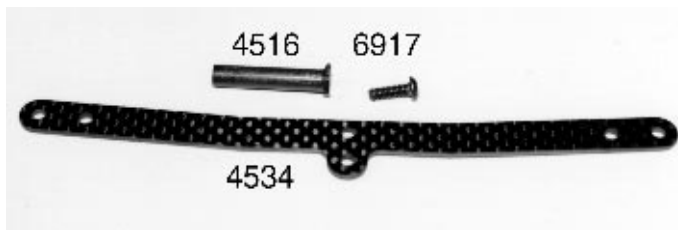

Fig. 29

#6917
4-40 x 3/8

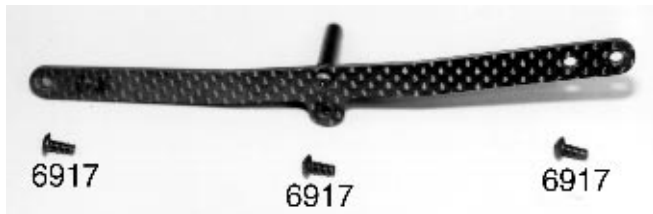

Fig. 30

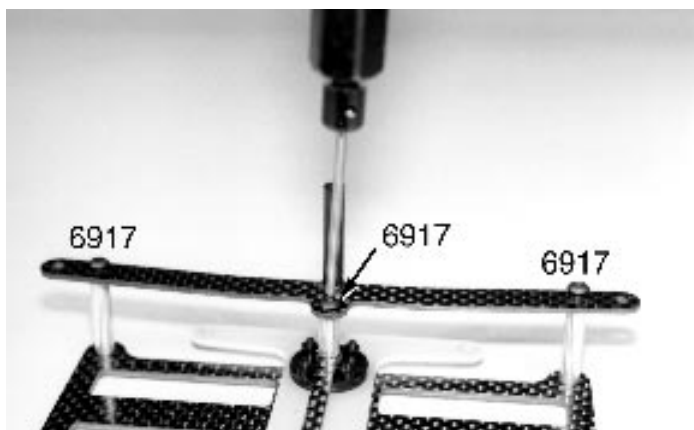

Fig. 31

Fig. 32 & 33 Now remove one #4517 dampener spring, one #4340 plastic dampener washer, and one #8330 black O-ring. Place the #4517 spring over the #4515 plastic dampener post. Now insert the #8330 O-ring into the center cavity of the #4340 plastic dampener washer. Install the plastic dampener washer over the plastic dampener post O-ring side first. This will leave the flat smooth side facing up. **Racer's Tip:** Team drivers will use some of their diff lube to coat the Black O-rings. This will reduce the friction between the O-ring and the dampener post improving the car performance. Set the rest of bag #3 aside for now. We will come back to it later. **Warning!!:** Make sure the #6917 center screw and the #6915 screw do not touch when both are tightened up. Contact will allow the pivot ball to move excessively reducing the performance of the T-bar and rear end assembly.

#8330
black O-ring

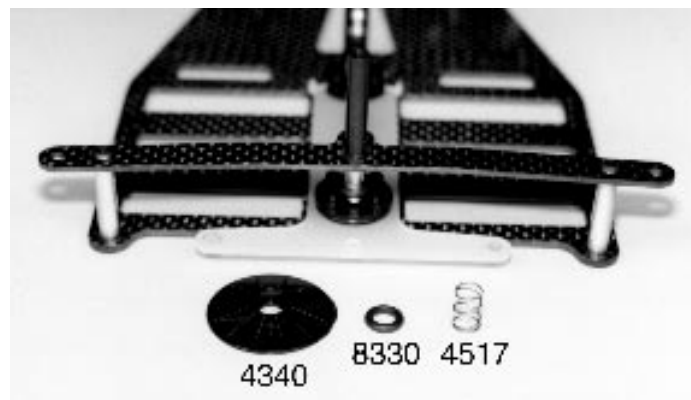

Fig. 32



Fig. 33

REAR END ASSEMBLY

Fig. 34 & 35 Open bag #4 and remove the #4532 graphite lower pod plate, #4536 molded left side rear bulkhead, and three #6292 4-40 x 3/8" FHSScrews. Line the left rear bulkhead up with the three mounting holes in the lower pod plate as shown. Use the three #6292 screws to fasten the bulkhead to the lower pod plate.

Now remove the #4537 right side aluminum motor mount and two #6292 4-40 x 3/8" FHSScrews. Line the right side motor bulkhead up with the mounting holes on the lower pod plate, as shown. Use the two #6292 screws to fasten the bulkhead to the lower pod plate.

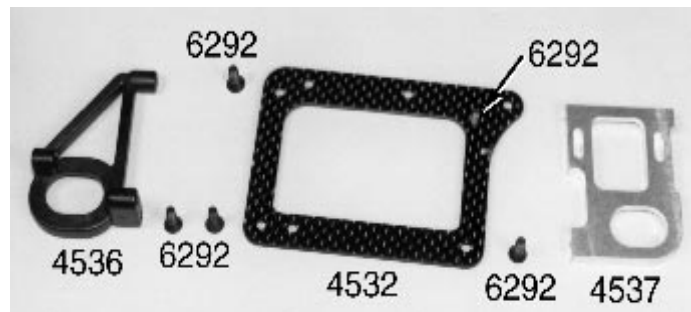

Fig. 34

#6292
4-40 x 3/8



Fig. 35

☐ **Figs. 36 & 37** In the same bag you will find three #4526 plastic T-bar spacers and three #6292 4-40 x 3/8" FHSScrews, and three #4449 4-40 small aluminum locknuts. For the standard assembly we will only need two of each. Install two #6292 screws in the two outer T-bar mounting holes of the lower pod, as shown. Place one of the #4526 plastic T-bar spacers over each screw. Line the screws up with the two outer mounting holes on the back of the T-bar. Now slide the T-bar over the screws and secure the assembly with the two #4449 4-40 small aluminum locknuts. *Racer's Tip: You can stiffen the front to rear flex of the T-bar for different conditions. Install the third #4526 T-bar spacer, #6292 4-40 screw and #4449 4-40 small aluminum locknut into the center hole of the T-bar mounting holes. We will discuss this in more detail in the tuning section at the end of the manual.*

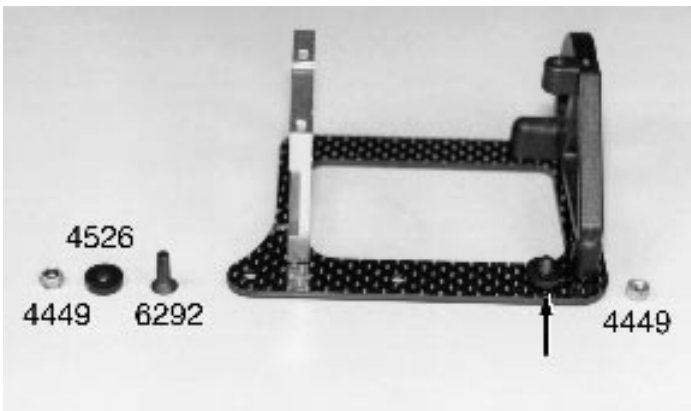

Fig. 36



 #6292 4-40 x 3/8
 #4449 4-40 locknut
 #4526 spacer



Fig. 37

☐ **Fig. 38** Now remove the #4530 graphite upper dampener plate, one #4448 aluminum ball end, and one #4449 4-40 small aluminum locknut. Layout the dampener plate as shown. Now install the #4448 aluminum ball end into the front hole and thread the #4449 4-40 small aluminum locknut onto the threaded end. Make sure the ball end is up and the cutaway side is to the left as shown.



Fig. 38

 #4448 ball end aluminum
 #4449 4-40 locknut

☐ **Figs. 39 & 40** Take out two #6919 4-40 x 5/16" BHSScrews, and one #6917 4-40 x 3/8" BHSScrew. Place the #4530 dampener plate assembly on top of the rear pod assembly. The cut away side of the dampener plate will be to the left or drivers side and the plastic dampener post will be coming through the dampener hole as shown. Use the #6917 screw to secure the dampener plate to the left molded bulkhead and the two #6919 screws to the right side aluminum motor plate as shown.



 #6919 4-40 x 5/16
  #6917 4-40 x 3/8

Fig. 39

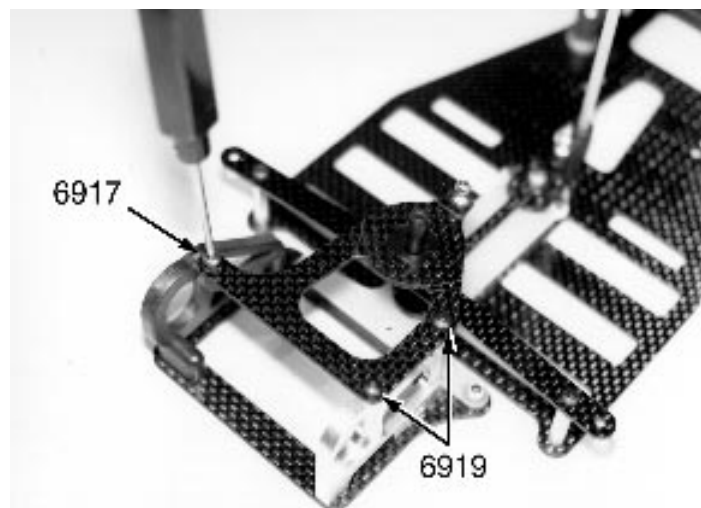





Fig. 40

Figs. 41, 42 & 43 Now go back and get the remainder of bag #3 we set aside earlier. Take out one #4340 plastic dampener washer, one #8330 black O-ring, one #4517 dampener spring, one #6920 4-40 x 3/16" BHSScrew, and one #6466 1/32" plastic washer. Push the #8330 O-ring into the center cavity of the #4340 plastic dampener washer. The Team drivers use diff lube on the O-ring to improve the performance of the dampener system. Now place the plastic dampener washer over the dampener post smooth side down. Next install the #4517 dampener spring over the post. Finally insert the #6920 screw into the #6466 washer and then thread it into the top of the dampener post.

In the same bag you will find the two #4518 plastic dampener roll stop inserts. Take them out and look at them so you will know what they look like. Now put them in your tool box. We will discuss using these later in the tuning section of the manual. We do not use them for the standard setup.

 #8330 black O-ring
  #6920 4-40 x 3/16
  #6466 1/32" spacer

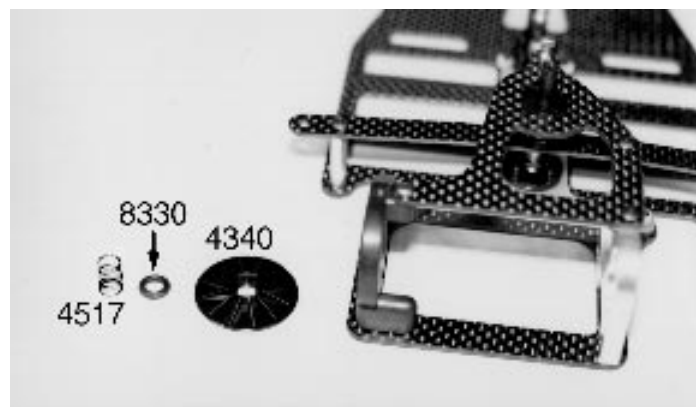

Fig. 41

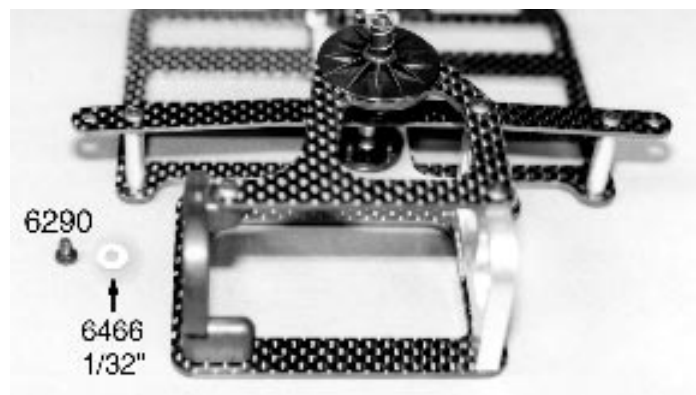

Fig. 42

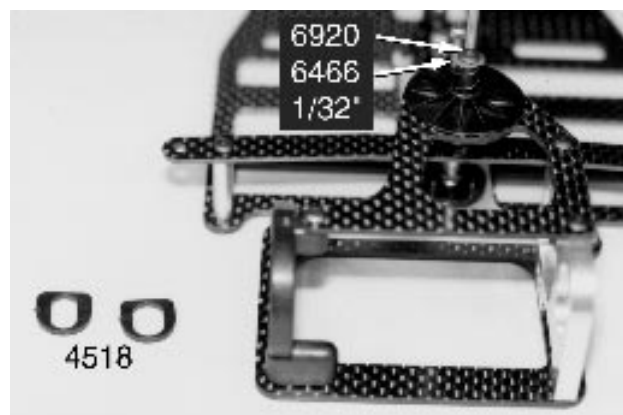

Fig. 43

Figs. 44 & 45 Remove the two parts trees that contains the #4348 zero offset (this one is marked with three dots), 4349 #1 offset, and #4350 #2 offset rear axle bearing height adapters. For this kit use the #4350 #2 adapters. Remove them from the parts tree and insert one adapter into the right side aluminum motor bulkhead. Now install the second adapter into the left molded bulkhead. When installed, the bearing hole offset should be closer to the ground as shown.

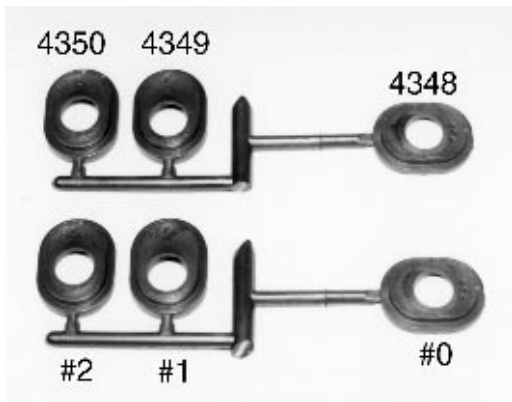

Fig. 44



Fig. 45

Fig. 46 & 47 Go back to the kit master bag and remove the bearing bag. Inside the bearing bag you will find one #7359 1/4" x 3/8" unflanged ball bearing, four #897 1/4" x 3/8" flanged ball bearings and four #3656 1/8" x 5/16" unflanged ball bearings. Take two #897 bearings and insert one into each #4350 adapter as shown.

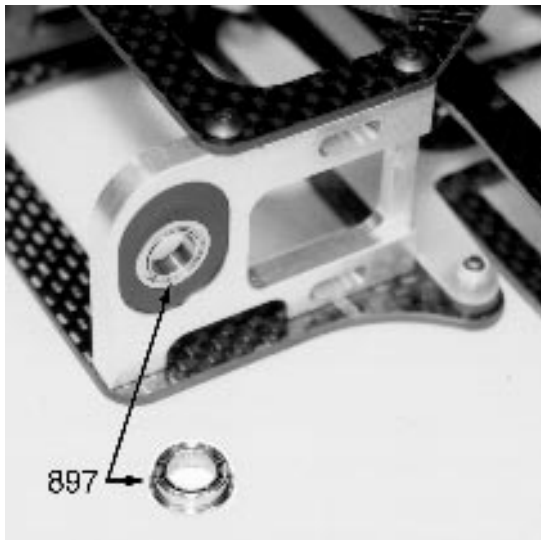

Fig. 46

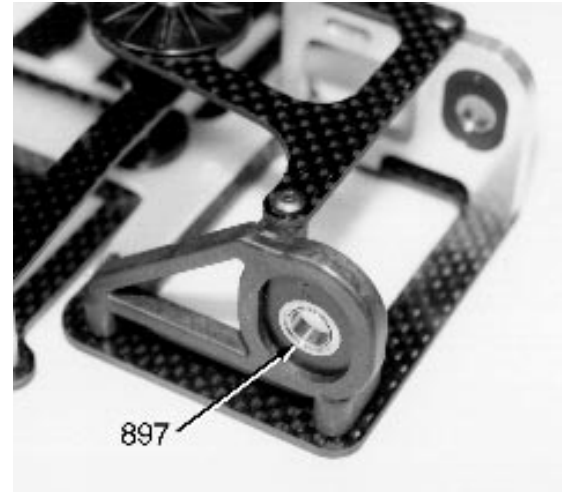
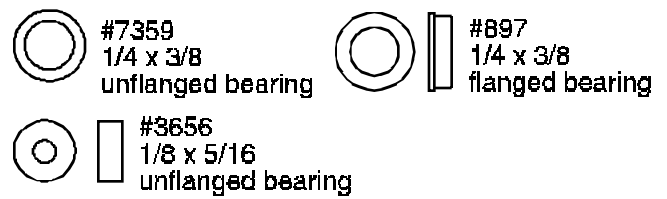

Fig. 47

REAR AXLE ASSEMBLY

Fig. 48 Open bag #5 and remove the #4460 75 tooth 48 pitch spur gear and the bag containing the six #3432 1/8" diff balls. Now go to the master bag and remove the tube of #6636 Associated diff lube. Look at the center of the spur gear. You will see two rings of holes. Use the inner ring of holes and fill each of the six holes with #6636 diff lube. Now press the #3432 balls into the same six holes. Use your finger to push the diff lube that pushed out back into the hole.

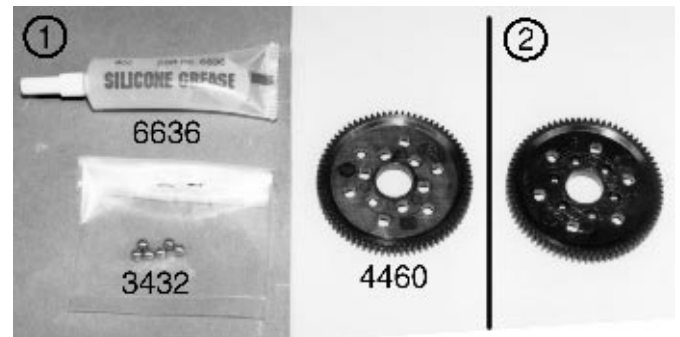

Fig. 48

Fig. 49 Now we can assemble the rear axle. Take out the #4456 S2 graphite rear axle, two #6579 tranny drive rings, and the #4458 S2 right diff hub spacer. The #4459 S2 Belleville washer, and the #4185 8-32 nylon locknut from bag #5. From the bearing bag remove the #7359 1/4" x 3/8" unflanged ball bearing.

To make the assembly easier, stand the axle on end so that the threaded end is facing up (we have laid the parts down to make the photo easier to shoot). Now take one of the #6579 drive rings, put a thin coat of diff lube on it and slip it over the end of the axle. Center it on the diff hub. Next slide on the #7359 ball bearing. This is followed by the #4460 spur gear and diff balls we assembled in fig. 48.

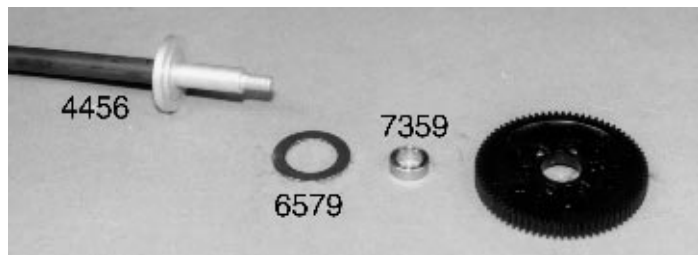

Fig. 49



Fig. 50 Take the two remaining #897 1/4" x 3/8" flanged ball bearings and install one into each side of the #4458 diff hub spacer.

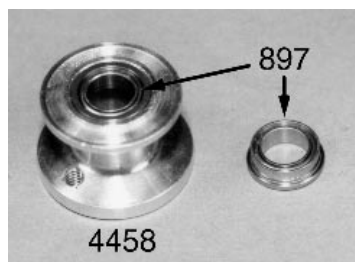

Fig. 50



Figs. 51, 52 & 53 Now install the second #6579 drive ring. This is followed by the #4458 diff hub spacer (with bearings). Each side of the diff hub spacer is flanged. On one flange there are two threaded holes. This will be the wheel side. Slide the diff hub spacer on so the unthreaded side goes on first. Now center this hub onto the #6579 drive ring.

Look at the #4459 Belleville washer. Slide this washer over the threaded end of the axle with the raised outer edge facing out. This will put the load on the inner race of the outer #897 ball bearing. Finally, thread on the #4185 8-32 nylon locknut and snug it down. Fig. 51 shows the #4458 without the #897 bearings from fig. 50 installed. We will adjust the diff at the end of the assembly manual. Go ahead and set aside the four #3656 ball bearings that remain in the bearing bag. We will not need them until later in the manual.

Go back to bag #5 and remove the #8321 aluminum rear axle spacer (fig. 52). One side of the axle spacer has a raised lip. Slide the axle spacer over the graphite portion of the axle with the raised lip facing away from the diff assembly. Now take the axle assembly and install it into the rear pod assembly from the right or passenger side. Slide the axle through the bearing in the right motor plate and then out through the bearing in the left bulkhead.

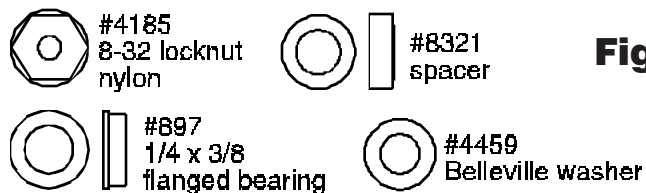
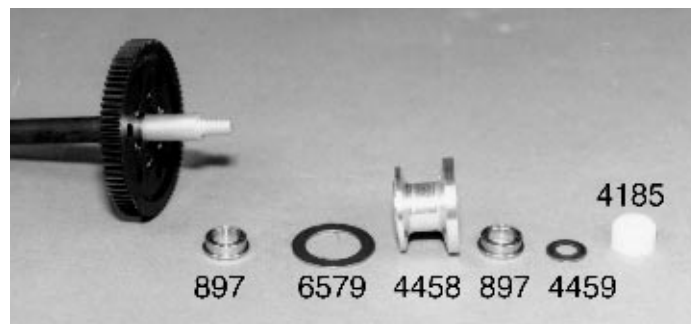

Fig. 51

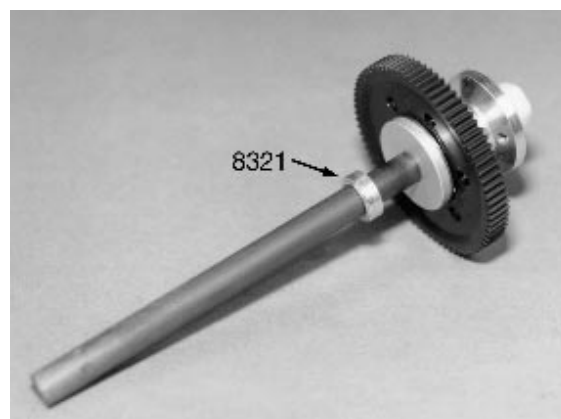

Fig. 52



Fig. 53

Figs. 54 & 55 Remove the #4540 left wheel hub and the #4436 4-40 x 5/16" socket set screw (bag #5). Thread the set screw into the left wheel hub. Look at the wheel hub. You will see that one side has a larger raised circular area and the other is a smaller circular area that is beveled on the outer edge. Now slide the wheel hub onto the left side of the rear axle. We want the smaller circular side to go on first. Seat the hub against the bearing and tighten the set screw. Do not force the hub against the bearing; we want to have a couple of thousandths of end play on the axle. The only screws remaining in bag #5 will be the four #6932 4-40 x 5/16" SHCScrews that are for mounting the rear wheels. Set these aside; we will use them later.

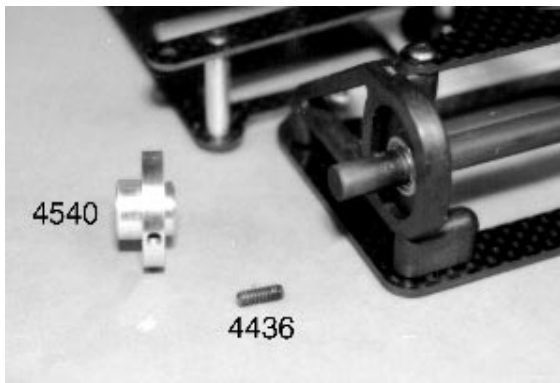

Fig. 54





 #4436
4-40 x 5/16
Allen screw

Fig. 55

SHOCK ASSEMBLY

Figs. 56 & 57 Open bag #6, the shock bag, and remove the #4511 molded front shock/antenna mount, one #4448 aluminum ball end, and two #7673 4-40 x 5/16" FHSScrews. Look closely at the #4511 shock/antenna mount. One side is flat. This will be the bottom of the mount. Now look at the top. One side is larger than the other. Thread the #4448 aluminum ball end into the small side. Now go to the master bag and remove the #4510 fiberglass antenna rod. The plastic end cap will already be installed. Push the exposed end of the antenna rod into the hole in the large side of the shock/antenna mount.

In front of the T-bar you will see the two mounting holes for the shock/antenna mount. Use the two #7673 4-40 screws from the bottom of the chassis to secure the mount to the chassis.

 #4448
ball end
aluminum

 #7673
4-40 x 5/16

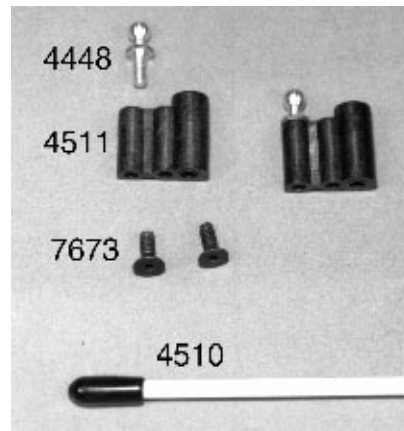

Fig. 56

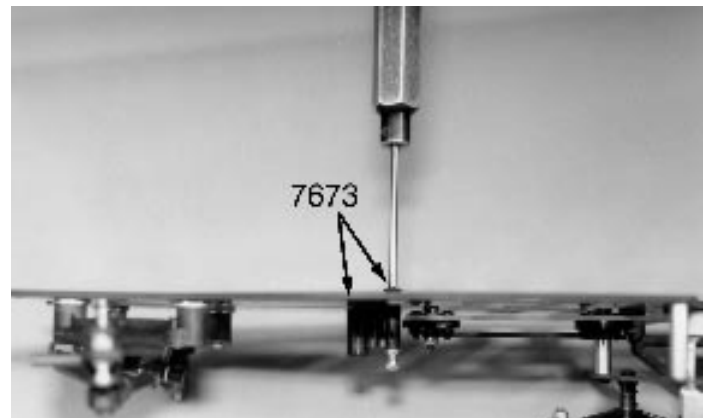



Fig. 57

Figs. 58, 59 & 60 Now we can begin assembly of the Delta shock. **Note:** Associated does not have individual replacement parts for the Delta shock, unless you see an Associated part number indicated in the photos and written instructions. We will start by removing the #4445 small red O-ring, the Delta shock piston/shaft assembly and the small brass washer. Slide the #4445 O-ring onto the piston/shaft assembly followed by the brass washer. Push them down against the shock piston. Next remove the Delta aluminum shock body, the black nylon spring adjusting collar and one #6274 plastic ball end cup from bag #6. Thread the black nylon spring adjusting collar onto the shock body. Make sure the hex portion is away from the large end of the shock body. Thread it on just enough for all the threads on the adjusting collar to be on the shock body. Now thread the #6274 plastic ball end cup onto the small threaded nipple of the shock body. Again thread it down to the end of the threads.

From the same bag remove the black plastic shock end cap and the shock internal spring. Look at the plastic shock end cap. If your cap has any flashing on the side away from the threads it must be trimmed off flush as shown in fig. 60. Now insert the internal spring into the end of the plastic end cap.

 #4445
red O-ring

 #6274

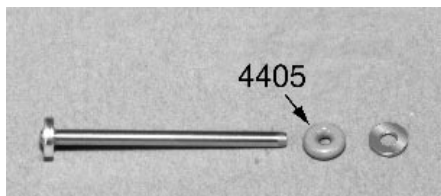

Fig. 58

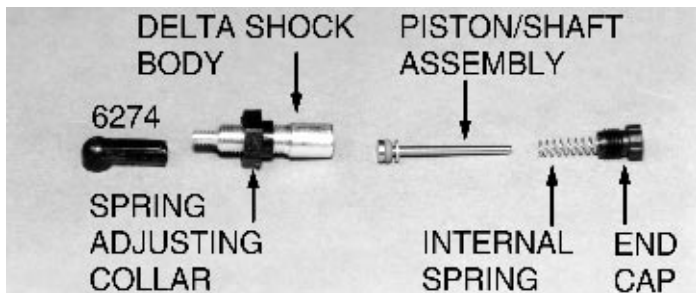

Fig. 59

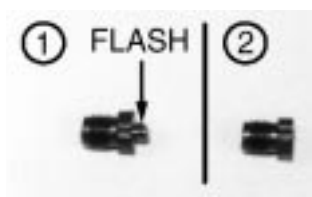

Fig. 60



Fig. 61



Fig. 62

Fig. 61, 62 & 63 From the master kit bag remove the bottle of #5415 20 weight shock oil. Now hold the shock body at a slight angle. Slowly add shock oil to the body. Let the oil run down the inside wall of the shock body to prevent air bubbles. Fill the shock body with oil to the **BOTTOM** of the threads. Be sure to keep the shock upright after the oil has been added. **Note:** We do not recommend the use of Silicone shock oil in the Delta shock. The shock volume is too small to use Silicone oil.

Pick up the shock piston/shaft assembly and slowly push it down into the shock body. Be careful not to create any air bubbles or lose any oil. Now slide the shock internal spring and black plastic end cap over the end of the shock shaft.

Slowly screw the plastic end cap into the shock body two turns. Now we must bleed the shock. **THIS IS THE MOST IMPORTANT PART OF THE SHOCK ASSEMBLY.** It will take several minutes. Push the shock shaft in very slowly. We want the shaft to go all the way in and touch the bottom of the shock. If there is too much oil in the shock the shaft will not go all the way down. If you find there is too much oil in the shock you will need to bleed some out. To do this unscrew the cap. Now slowly push the shock shaft all the way down. You can now thread the plastic end cap back in two threads. Recheck the shock piston travel. If it is still not right repeat the process. If everything is OK thread the plastic end cap all the way down. **WARNING! Do not use a wrench!** Now do a final recheck to make sure the shock shaft goes all the way down. If not readjust as indicated above. We want the shaft to go all the way in and feel smooth but the shaft should also come out all the way by itself. Now move the shaft in and out. If you feel any small jerky motions, you have air inside the shock and you will have to add oil. Do not try to rush this job. When this is accomplished the shock is correctly assembled.



Fig. 63

Fig. 64 & 65 Now we can remove the #4446 Delta shock spring, the aluminum shock shaft end cap, one #6951 4-40 x 1/8" socket set screw, and one #6274 plastic ball end cap. We can start by threading the #6951 set screw into the shock shaft end cap. Then we need to thread the #6274 plastic ball end cap all the way onto the nipple of the aluminum shock shaft end cap.

Slide the spring onto the shock body and down against the spring adjust collar. While holding the spring collapsed, slide the aluminum shock shaft end cap onto the shock shaft and securely tighten the #6951 set screw against the shaft. Now go ahead and tighten the spring adjust collar all the way down. Fig. 65 shows the completed shock assembly.

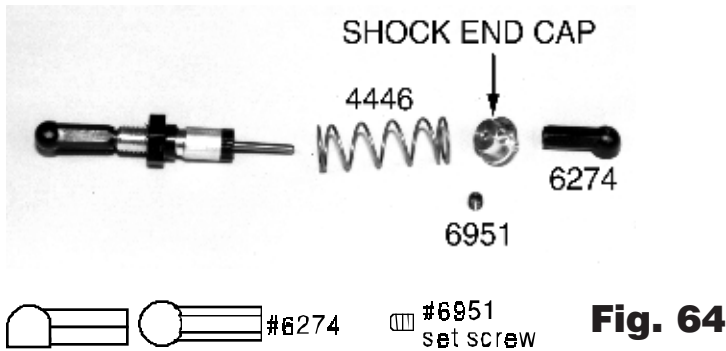

Fig. 65

Fig. 66 Now attach the shock to the aluminum ball ends that are located on the shock/antenna mount and the rear dampener plate. Make sure that the spring adjusting nut side of the shock is closer to the shock/antenna mount.



Fig. 66

BODY MOUNT ASSEMBLY

Fig. 67 Open bag #7. We will start by installing the rear body mounts. Remove two #4513 rear mounts, two #6917 4-40 x 3/8" BHSScrews, two #7320 nylon body washers, and four #6332 body clips. Now we install the rear mounts on the ends of the rear chassis brace using the two #6917 4-40 screws. Place the body mount on top of the chassis brace and thread the #6917 screw in from the bottom. Go ahead and install the other side. Make sure the holes in the mounts point across the chassis. For now install one body clip in the bottom hole of each rear body mount. Now slide the #7320 body washers over the rear mounts so that they rest on the body clips. Install a second body clip into each mount over the body washer. Right now it does not matter which hole.

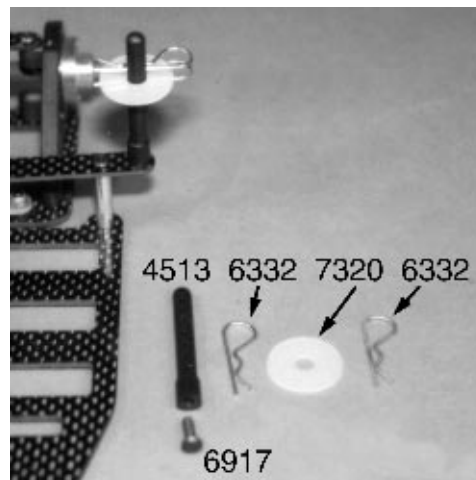

Fig. 67

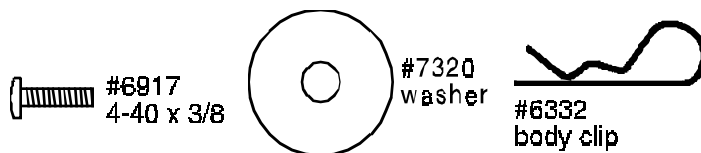

Fig. 68 Now remove two #3320 front body mounts, two #3324 8-32 x 1/2" aluminum FHMScrews, and two #3323 #8 thick aluminum flat washers. Install the two #3324 screws through the bottom of the chassis as shown. Slide the #3323 #8 thick washer over the screws and thread on the #3320 front body mounts. Line up the holes in the body mounts so they point across the chassis just like the rear mounts. *Racer's Tip: It can be hard to hold the body mounts when they are being tightened down. To give you something to hold onto you can either insert a body clip or your .050" Allen wrench into the hole. This will help to prevent the body mount from turning as you are tightening down the screws.* Go ahead and install the two remaining #6332 body clips into the front mounts.

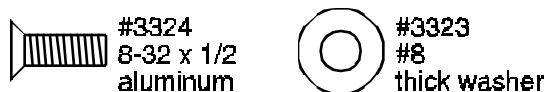
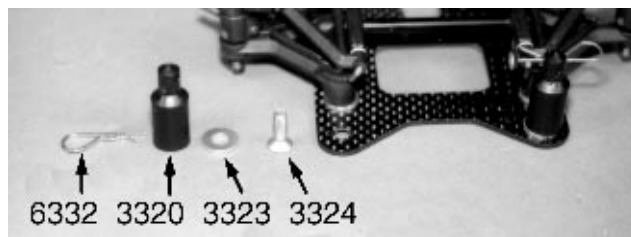

Fig. 68

MOTOR ASSEMBLY & INSTALLATION

Fig. 69 Your kit does not come with a motor or pinion gear, so if you have not picked one out yet now is the time to do so. We recommend Reedy motors for both stock and modified class racing. Reedy Motors have won seventeen World Championship titles. This is more than all other motor manufacturers combined. The major portion of all of our electric World and

National titles were also won with Reedy motors. If you are not sure which motor to get check with your local dealer or you are welcome to contact Associated at 714-850-9342 and we will do our best to assist you.

We will start by installing the capacitors onto the motor. Some motors come with one or two capacitors installed. We want to end up with a total of three. The following drawings show the more common soldering locations for both stock and modified motors. Please check your speed control manual to make sure you have the right type and quantity of capacitors. Most speed controls use .1mfd (micro farad) capacitors rated at 25 volts.

STOCK MOTORS

front

rear

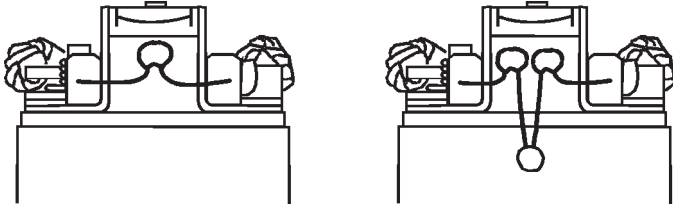

MODIFIED MOTORS

front

rear

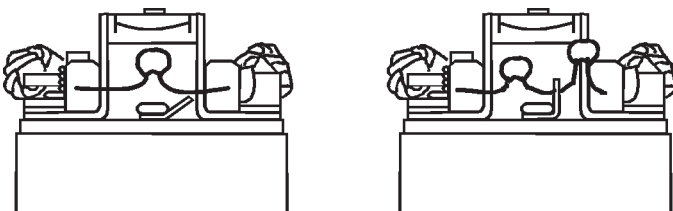

Fig. 69

Fig. 70, 71, 72 & 73 In the master kit bag you will find the small bag that contains the two #6515 3mm x 10mm gold colored SHCScrews, and two #7337 gold colored steel washers. Slide one of the #7337 washers onto each screw. Now turn the chassis up on it's right side. Pick up your motor and insert it through the lower pod plate and place it against the motor plate, shaft end first. Now turn the car back over. Line up the mounting holes in the motor with the motor adjusting slots in the motor plate. Use the two #6515 screws to secure the motor to the motor plate. Leave the screws loose for now. Locate the pinion you chose to use with your motor choice. Insert the pinion set screw into the pinion and then slide the pinion onto the motor shaft. Make sure the set screw side of the pinion goes onto the shaft first. Rotate the pinion until the set screw is lined up over the flat portion of the motor shaft. Now check the alignment of the pinion gear with the spur gear. Make sure you have full contact across the face of each gear. Go ahead and secure the pinion gear when you have achieved this.

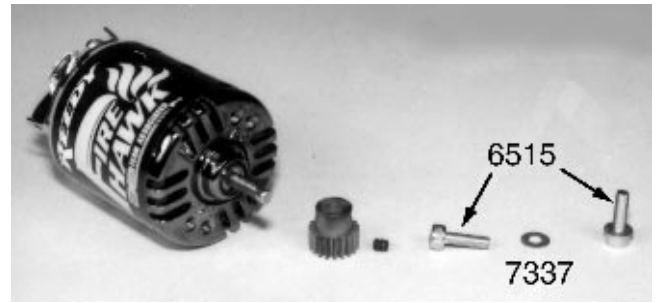

Fig. 70

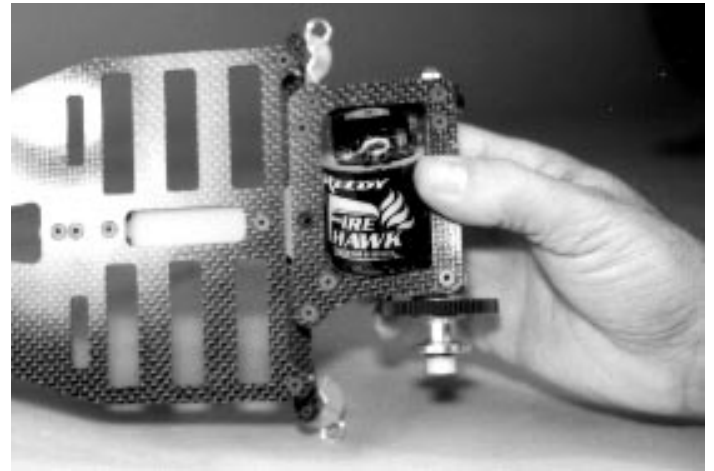

Fig. 71

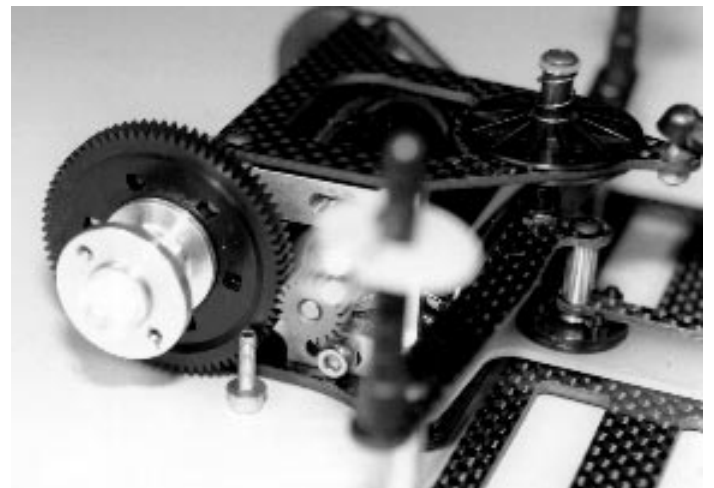

Fig. 72

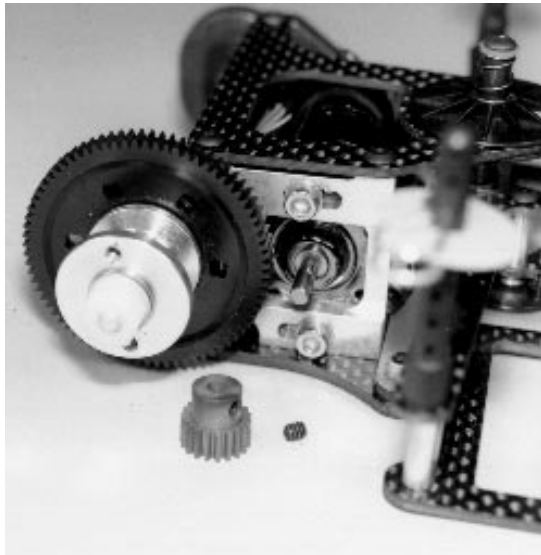

Fig. 73

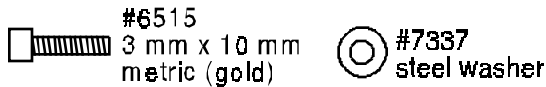

Fig. 74 Now we need to set the gear mesh. This is accomplished by moving the motor forward or back. This moves the pinion gear closer to or further away from the spur gear. What we want to accomplish is to get the metal pinion gear as close to the spur gear as possible, but without binding the gears. The easiest way to check this is to put your finger on the nylon spur gear. See if you can rock the spur gear teeth back and forth (lightly) between the pinion gear teeth without making the pinion gear move. We want the gears meshed as close as possible but still have the ability to rock the spur gear. When you have the spacing correct you can tighten down the two #6515 3mm screws. Now recheck the gear mesh to make sure nothing moved when you tightened down the screws. It is important to keep in mind that a tight gear mesh will result in a high power loss. A loose gear mesh can result in stripping off the spur gear teeth. So take your time. **WARNING! The gold colored motor screws are metric. The coloring was done to prevent mixing up the motor screws with the standard black 4-40 screws used in the rest of the kit. Accidentally using the 4-40 screws in the motor will strip out the mounting holes in the motor can. This damage to the motor can cannot be corrected except by replacing the motor.**

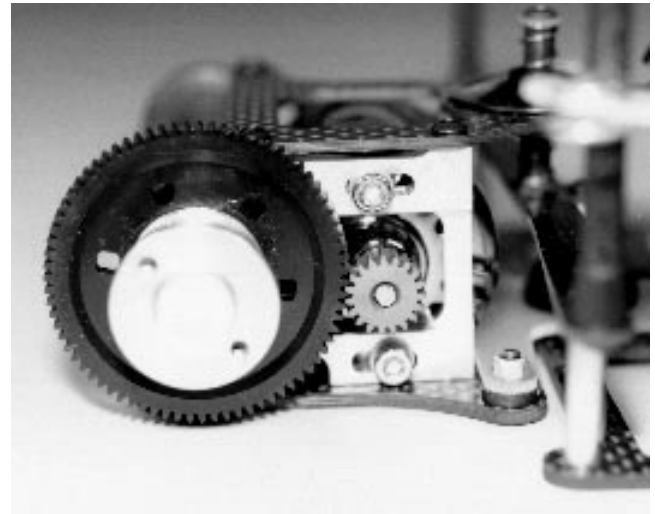

Fig. 74

STEERING SERVO & TIE-ROD ASSEMBLY

Most radio systems come with standard medium size servos. Because of space limitations a medium servo will not fit. The stock servo mounting holes will accept the following servos that we have been able to test.

Airtronics	Futaba
94143	S-32H/S-32SH
94144	S-132H/S132SH
94145	S-9601
94831	

If you have a servo not listed here, make sure it fits before you try to install it. Other servos may fit, but also may require drilling new mounting holes in the chassis.

Note: We only supply one servo saver with the kit. As a random choice we have included the Airtronics servo saver. If you have a Futaba servo or other brand you will have to purchase the correct servo saver.

Fig. 75 & 76 Go back and take out bag #1 that we set aside early in our assembly. From this bag remove the two #8435 molded steering servo mounting blocks. The drawing below shows which holes to use with the different size servos. Now determine which mounting holes are correct for your servo. Take out your drill motor and #43 drill bit. (Remember if you could not find a #43 drill bit a 1/8" bit will work if you are very careful). Drill the correct two holes in each mount for your servo. Make sure the hole is perpendicular to the mounting face of the servo mounting block.

Next remove the #3760 Airtronics servo saver, two #4448 aluminum ball ends, and two #4449 4-40 small aluminum locknuts (also in bag #1). Please remember if you have a Futaba or another brand of servo you will have to purchase the correct servo saver. The photo shows the eight holes in the servo saver. You will need to drill out the top two holes (one on each side). We want the balls to be as close to the servo horn

pivot point as possible. Use your #34 drill bit, or your 3/32" if you cannot find a #34 bit. After you have drilled out the holes install the two #4448 ball ends into the servo saver and thread the two #4449 locknuts onto the ends of the threads. **WARNING! The ball ends should just be able to slide through without threading. The holes are close enough to the edge of the servo saver they could crack through if the ball ends were threaded in.**

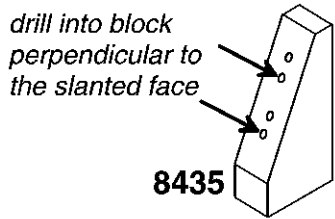
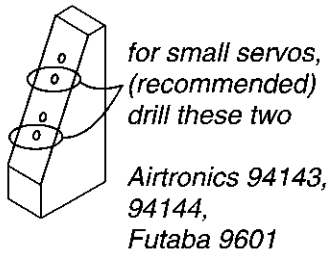
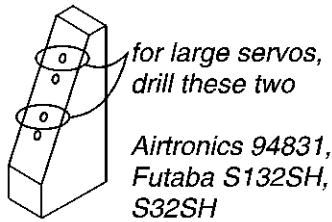

(NOT ACTUAL SIZE)

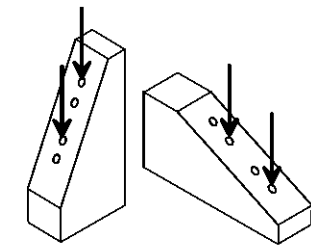

Fig. 75

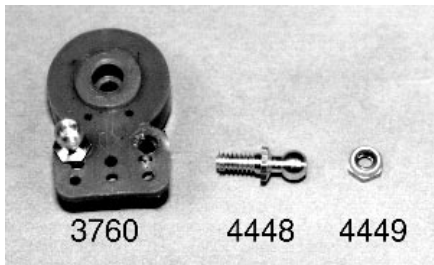

Fig. 76

Fig. 77, 78 & 79 Remove the four #4145 4-40 x 5/16" aluminum SHCScrews and four #7337 servo washers (small gold colored) from bag #1. Use the #4145 screws and the #7337 washers to secure the two #8435 servo mounting blocks to the servo.

Now remove the stock servo horn, if one came on your servo, and install the servo saver. We want the servo saver to be pointing down. Now check the throw of the servo saver in both directions. If it does not have the same travel in both directions, remove the servo saver and rotate it's starting position one or more splines and then reinstall it. Go ahead and secure the servo saver with the stock servo horn screw (for metal gear servos) or the screw that came with the servo saver. With the servo output shaft facing you, make sure the output shaft it to your right side. Your completed servo should look like fig. 79.

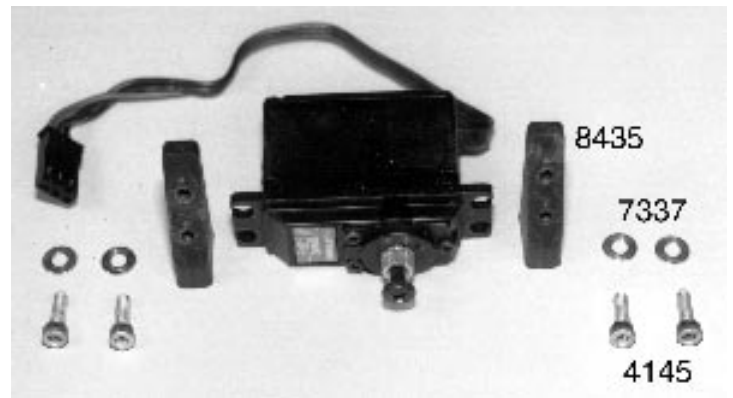

Fig. 77

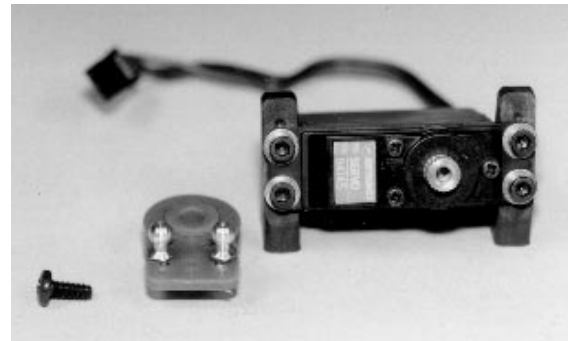

Fig. 78

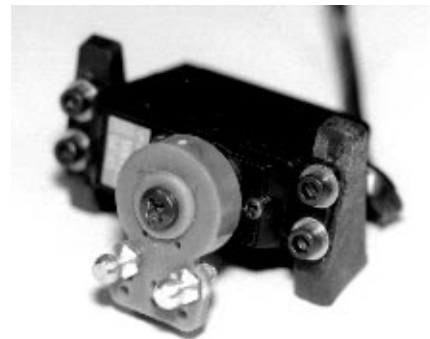
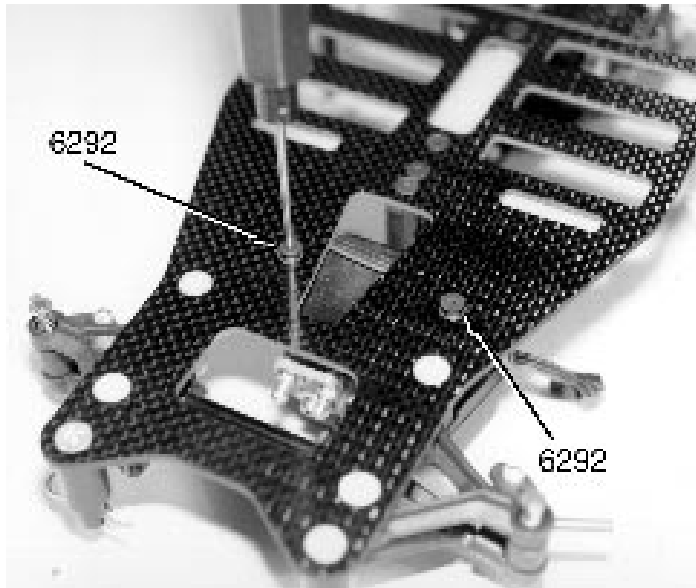

Fig. 79

#4145
4-40 x 5/16
aluminum

#7337
steel washer

Fig. 80 In bag #1 you will find two #6292 4-40 x 3/8" FHSScrews. We will use these to secure the servo mounts to the chassis. The holes for mounting the servo to the chassis are spaced so that the most popular Airtronics or Futaba servos will fit. You may have to adjust the placement of the #4145 screws in the mounting locations but this is all that should be required. If you are running a different brand of servo you may have to drill new holes if the existing ones do not line up correctly. Use the two #6292 screws to secure the servo to the chassis as shown.



 #6292
4-40 x 3/8

Fig. 80

Figs. 81 & 82 Now we need to take out the two #4404 turnbuckles and four #6274 plastic ball end cups. Screw one #6274 plastic ball end cup onto the end of each turnbuckle evenly. The turnbuckles have left hand threads on one end and right hand threads on the other end. This means the ball end cups will thread on in opposite directions. Adjust the ball end cups until you reach an adjusted length of about 2 3/16" (about 55.5mm or 2.18"). **All measurements are done from the center of the ball cup hole to the center of the opposite ball cup hole.** Because the servos may place the output shaft in slightly different positions you will have to fine tune the front toe-in after everything is installed. Notice the difference in the direction the ball cups face on opposite ends of the same turnbuckle. Also the right and left turnbuckles will be facing in opposite directions as shown in fig. 81.

Snap the assembled turnbuckles onto the steering block ball ends and the servo saver ball ends. It will be best to do this with your needlenose pliers. Remember there is a right and a left hand turnbuckle. You can adjust the front toe-in now or wait until the final adjustment section at the back of the manual.

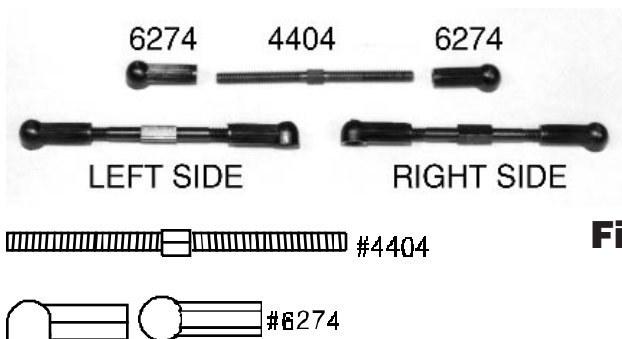

Fig. 81

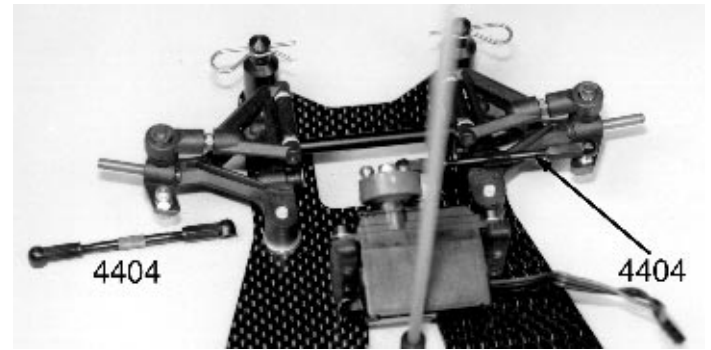

Fig. 82

Fig. 83 Your completed front suspension with steering servo should look like this.

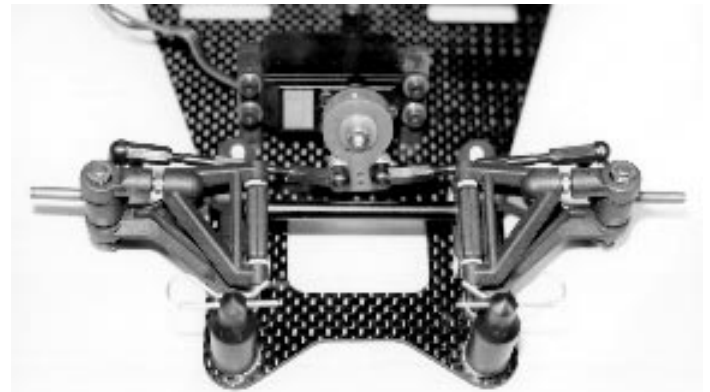

Fig. 83

BATTERY ASSEMBLY & INSTALLATION

Your new RC12LC is setup to run four or six cell saddle type battery packs. Some companies offer these in pre-assembled packs but most people will have to assemble their own. The following steps will show you the correct way to assemble a six cell saddle type battery pack if you do not already know how.

Figs. 84 & 85 Make sure you use ROSIN core solder, the preferred being the more popular 60/40 variety. **DO NOT** use acid core solder. This can damage your electrical components and connections. Fig. 84 shows the right or passengers side of the battery pack. Fig. 85 shows the left or drivers side view of the same battery pack. The cells are soldered in series. This means the positive end of the first cell will be soldered to the negative end of the second cell, and its positive end be soldered to the negative end of the third cell and so on. In between the third and fourth cell the connection will be made by a jumper wire. This wire has to be long enough to reach across the gap between the slots in the chassis and to be able to clear the T-bar. Normally we use 16 or 14 gage wire for this connection.

In order to connect the cells together you will need to use battery braid or battery bars. Normally battery braid is cheaper and a little easier to solder, but the battery bars help to stiffen the battery pack when it is being handled. Associated sells Reedy #650 battery braid and the new #651 silver treated battery bars for assembling battery packs.

If you are going to use connectors or plugs their wires will just be soldered to the cells at each end of the battery pack. If you are going to hard wire (the technique we show in the photos) you will need to bend the braid or battery bars so you will have an easy place to make the wire solder connections above the cells.

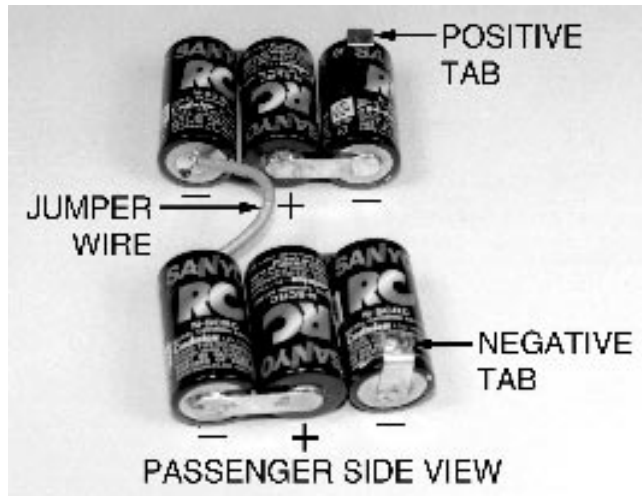

Fig. 84

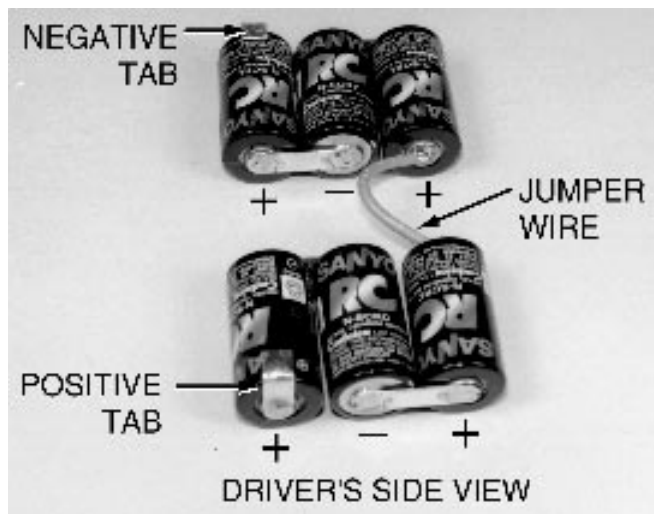

Fig. 85

reinforced strapping tape. The decision to use 1/2" 3/4" or 1" tape will be a personal choice. We do recommend that there be at least two layers of tape on the bottom and where it comes up out of the slots. When racing, the dots or discs that are used near the corners, at some tracks, can cut the strapping tape. This could cause the battery to come out of the chassis. The extra layer of tape will normally prevent this from happening. Fig. 86 shows the batteries in the slots and fig. 87 shows them secured by the reinforced tape.

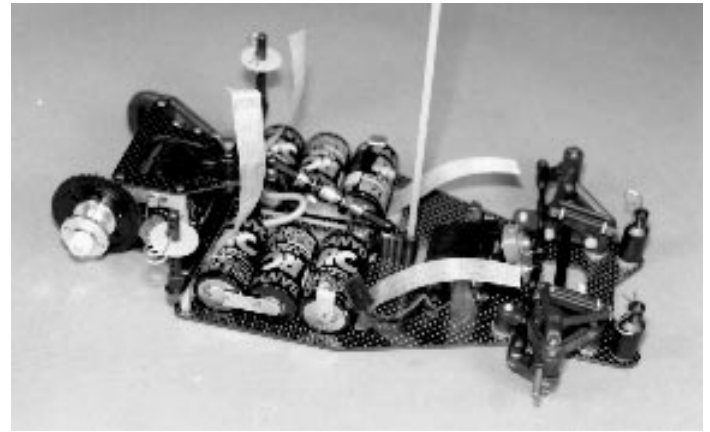

Fig. 86



Fig. 87

Fig. 86 & 87 Before you can place the battery pack on the chassis, you will need to disconnect one end of the shock from its pivot ball. This will prevent problems with the jumper wire between the third and fourth cell. Now place the assembled battery pack on the chassis slots then connect the shock back onto the ball end. If you are only using a four cell pack you will want to use the back slots. For our installation this will place the positive connection on the left (drivers side) front and the negative connection on the right (passenger side) front.

To hold the cells to the chassis we use fiberglass

RADIO RECEIVER INSTALLATION

We are now ready to begin the installation of the radio receiver. If you have not already chosen your radio system, Associated recommends staying with a top name brand radio system. Names like Airtronics, Futaba, JRpropo, or KOpropo are the most recognized brands available. Depending upon the type and size of components plus the number of cells you are using, your best layout may be different from the one shown in the manual.

□ **Figs. 88, 89 & 90** In the master kit bag you will find a 1 1/2" x 6" strip of double stick tape (servo tape). For our installation we show installing the receiver behind the servo on the right (passenger side) of the chassis. If you have a smaller receiver you may be able to install the receiver flat on the chassis. If you have a standard receiver you can mount it on its edge as shown.

Cut a piece of the servo tape to match which ever side of the receiver you want be secure to the chassis. Now take the antenna wire and coil it around the #4510 fiberglass antenna rod. When you reach the top of the antenna rod, remove the plastic end cap put the end of the wire over the top of the tube and then press the end cap back over the wire and rod. Fig. 89 & 90 shows the receiver installed on the chassis and the wire wrapped on the antenna rod with the plastic end cap installed.



Fig. 88

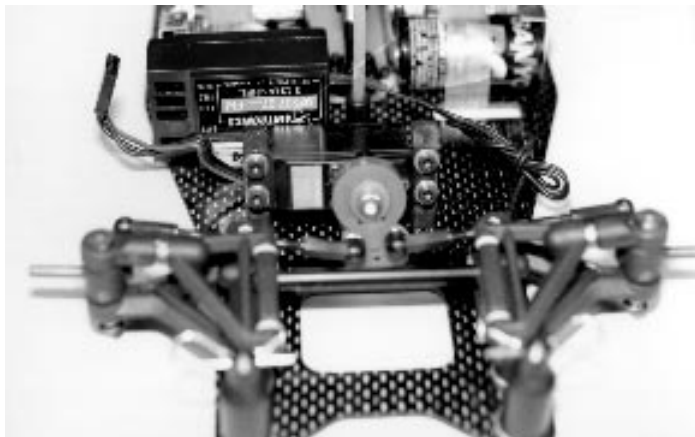

Fig. 89

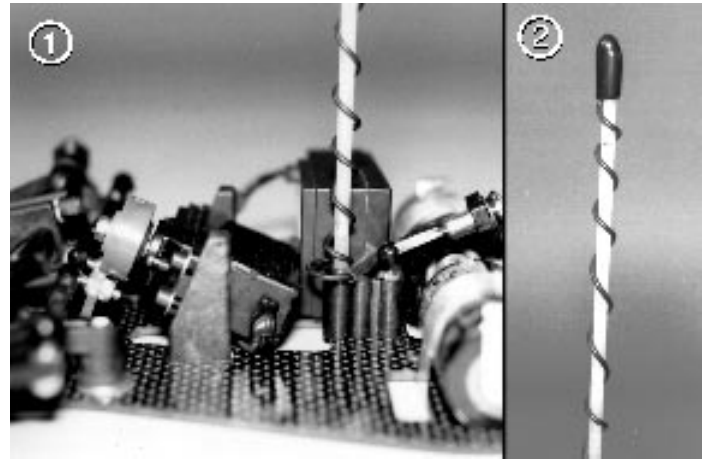

Fig. 90

ELECTRONIC SPEED CONTROL INSTALLATION

We can now begin to install the electronic speed control (ESC). Again we recommend using name brand speed controls. We consider the top brands to be LRP, Novak, and Tekin. If you stay with a high quality manufacturer like these you should not have any problems.

□ **Figs. 91, 92 & 93** Now cut another piece of servo tape to match the bottom of the speed control case. Attach the ESC to the chassis with the servo tape. Fig. 92 shows the proper location for our installation.

Now take the servo wire from the steering servo and plug it into channel #1 (rudd) of the receiver. Next take the servo wires from the ESC and plug it into channel 2 ("thro") of the receiver see fig. 92. You will find a small bag in the master kit bag which contains four #7709 4" electrical wire ties. You can use these to bundle the servo wires to clean up the wiring installation. Fig. 93 shows the servo wires bundled and secured with the wire ties.

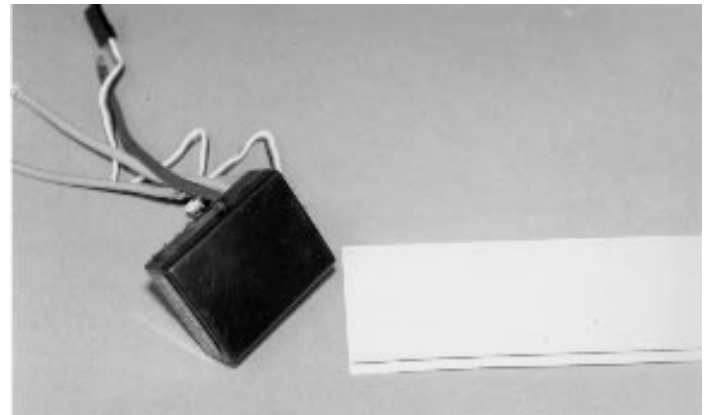

Fig. 91

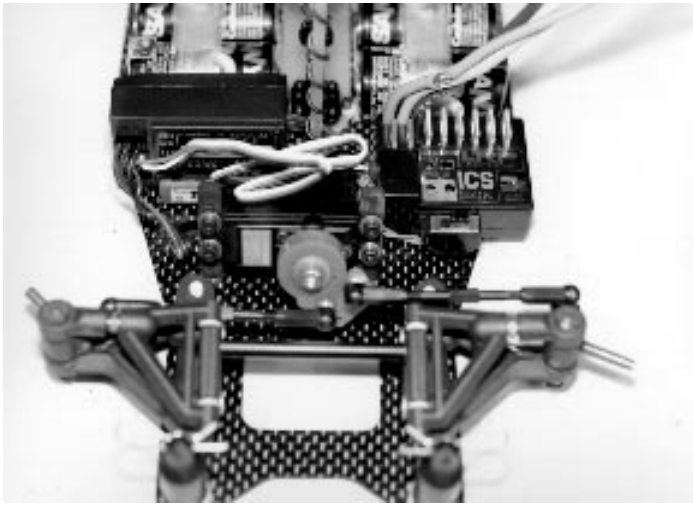

Fig. 92

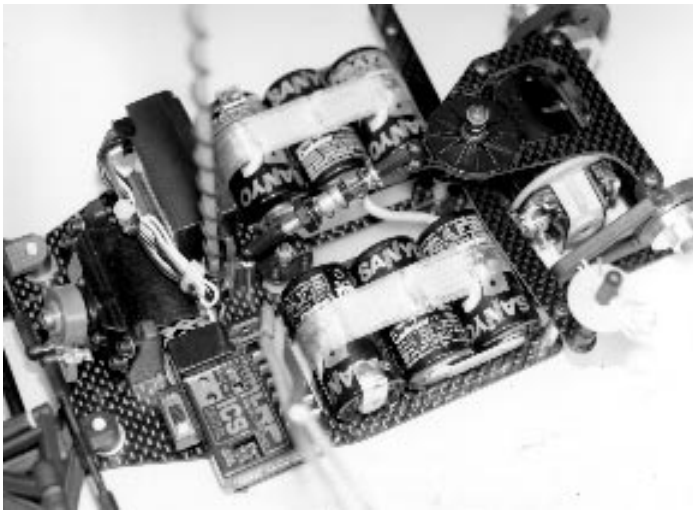

Fig. 93

□ **Figs. 94 & 95** Now we connect the battery and motor wires. Start by measuring the motor wires. We will start with the black battery negative wire. This connects to the negative tab of the battery on the right or passenger side of the car. Keep the wire as short as possible but still have a little bit of movement in the wire. We also want to keep the black wire about an inch away from the antenna wire. This will help to make sure that the antenna cannot pick up any electrical interference from the battery pack.

Next the red wire needs to be measured to the positive terminal on the motor. Also measure the blue wire which will go to negative terminal on the motor. Again, keep the wires as short as possible but leave enough slack for the movement of the rear pod and motor adjustment. If your wires are too short you affect the handling of the car.

Now connect the battery positive terminal to the speed control. Because the speed control is a three wire unit, make a jumper wire that will connect the battery positive terminal and will splice into the red motor lead from the speed control. Find a point on the red motor wire straight across from the battery positive terminal. Strip off a piece of the electrical insulation at

this location. Now use a piece of red wire, that was cut off the speed control when the motor positive lead was measured, to go between the red wire and the positive terminal of the battery pack. Fig. 95 shows all the battery and motor wires connected.

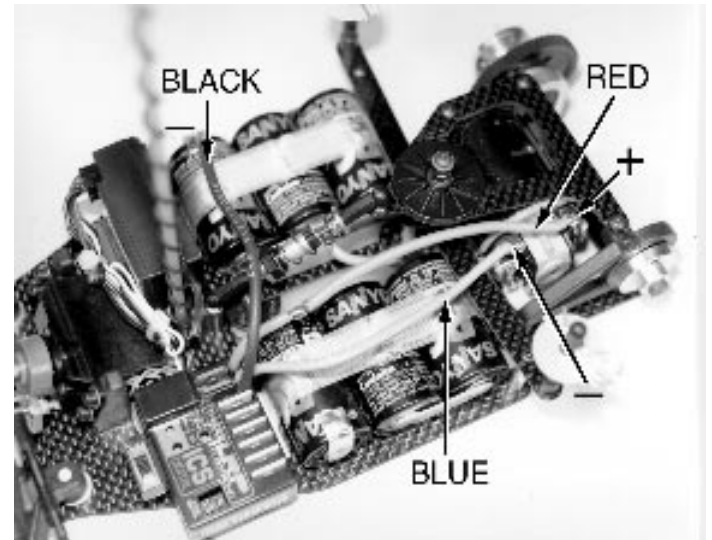

Fig. 94

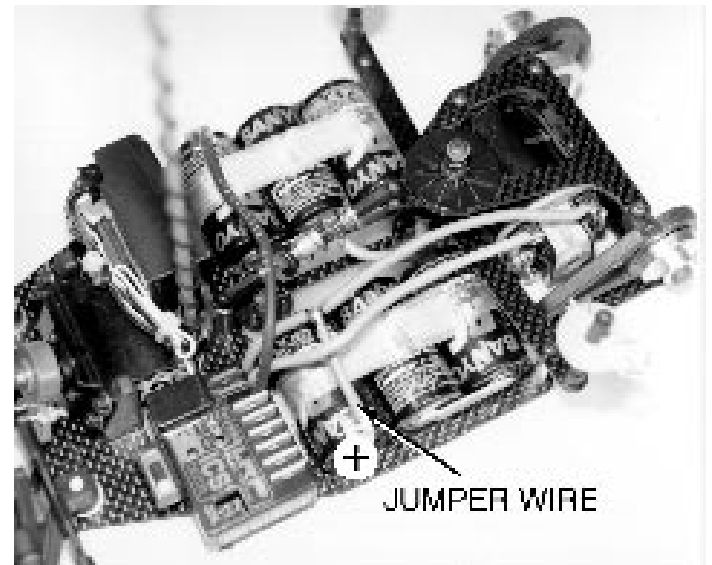

Fig. 95

WHEEL & TIRE INSTALLATION

□ **Figs. 96, 97 & 98** The final step before your car is assembled will be to install the wheels and tires. In your kit box you will find a smaller box. Inside you will find the two #3626 dished rear tires and wheels along with the two #3672 dished front tires and wheels. We will start by taking out the two #3626 rear wheels and tires. Go back to bag #5 and remove the four #6932 4-40 x 5/16" SHCScrews. Take one of the wheels and line up the mounting holes with the holes in the right wheel hub. Secure the wheel to the hub with two #6932 screws. Now do the same for the left rear wheel. **WARNING!!: Make sure the**

#6932 wheel screws do not go through the left wheel hub and touch the bulkhead.

Go ahead and remove the two #3672 front wheels and tires. Go back to bag #1 and remove two #4187 nylon front axle washer, and two #6299 1/8" E-clips. Any thing you have remaining in bag #1 will be spare parts (as long as you know you have assembled the car correctly). Now go back and pick the four remaining #3656 1/8" x 5/16" unflanged ball bearings in the bearing bag. Insert a bearing into each side of the front wheels. Now slide one of the #4187 front axle washers onto the right front axle. This will be followed by one of the front wheels. Now you can secure the wheel with one of the 1/8" E-clips. Repeat these steps to install the left front wheel. Remember there is only one #4187 nylon axle washer per front axle.

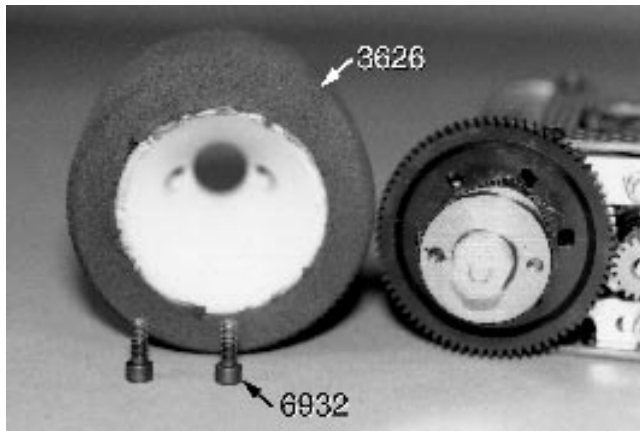
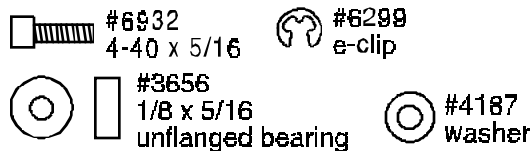

Fig. 96

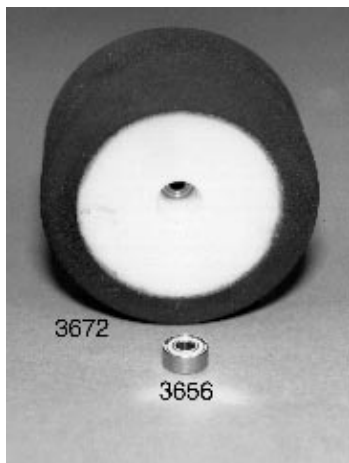

Fig. 97

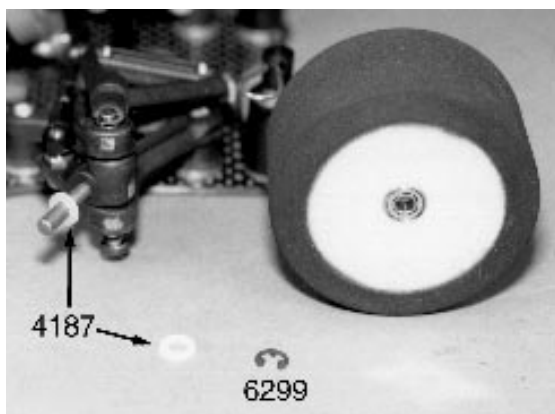

Fig. 98

Fig. 99, 100 & 101 With the car fully assembled, we can set the "tweak" on the chassis. We set the "tweak" after EVERYTHING is installed on the car, including batteries, motor, speed control, and all the radio equipment. The only item that does not have to be installed for this adjustment is the body.

WHAT IS TWEAK? Ideally, the left wheel should be pushing down on the ground with exactly the same force as the right wheel. If this is not happening, the car is TWEAKED (or twisted). This can cause the car to spin out easily under acceleration. It will also cause the car to oversteer in one direction and understeer in the opposite direction. Some racers set the tweak using the front wheels and some prefer to use the rear wheels to set the tweak.

BEFORE WE CAN CHECK THE TWEAK, we need to measure the distance between the outside edge of the left wheel and the outside edge of the right wheel. Choose which end of the car you want to use, then measure the distance between the outside edges of the left and right wheels as shown in fig. 99. The photo shows measuring the rear wheel spacing but you would do the same for the front wheel spacing. The center point will be exactly half of the wheel spacing measurement. Mark the bottom of the lower rear pod or front of the chassis with an X-acto knife. *Racer's Tip: Team drivers will take a small drill bit and make a countersunk mark on the center point. This makes it easier to put the X-acto knife in the same location every time without measuring.*

TO CHECK TWEAK start by putting the edged tip of your X-acto knife blade on the center mark you made on the lower rear pod or chassis plate. Lift up the end of the car you are setting the tweak from with the X-acto knife until the wheels are off the ground. Now slowly lower the knife (see fig. 100 & 101). We want both tires to touch the work bench at exactly the same time. If one tire touches the table before the other tire, the car is tweaked.

FOR OVAL RACING we recommend using the front end to set the tweak.

TO CORRECT THE TWEAK, refer back to fig. 23 where we installed the tweak screws. To adjust the tweak, loosen the tweak screw 1/8 to 1/4 turn on the tire side that touched last. Now tighten the opposite tweak screw (on the side that touched first) the same amount. Recheck the tweak. Continue to make these adjustments until both tires touch at EXACTLY the same time. When they do, you have adjusted the tweak correctly. **WARNING! Always loosen one screw first, then tighten the opposite screw the same amount.**

Your car is now complete. Congratulations, you did great!

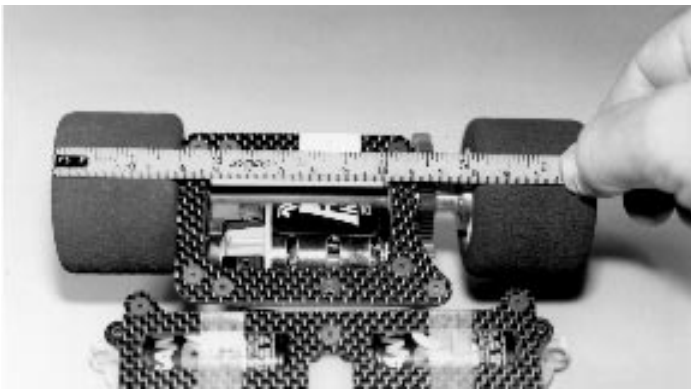

Fig. 99

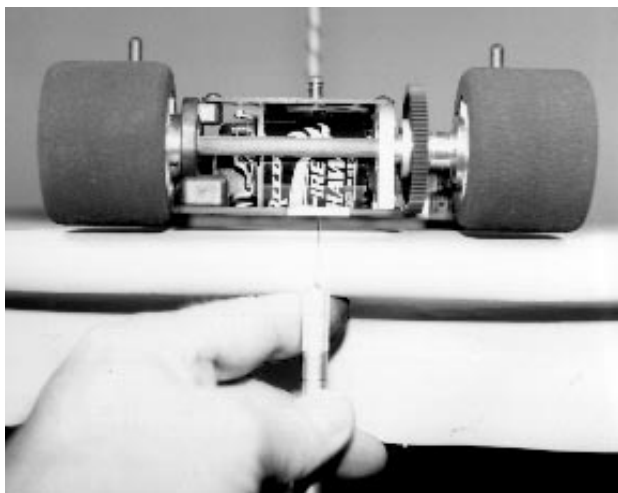

Fig. 100



Fig. 101

FINAL ADJUSTMENTS

BATTERY CHARGING. Charge your transmitter batteries if they are Ni-Cads. This will normally require an overnight charge. Next charge the battery pack for your car. Do this according to the battery and/or battery charger instructions. Make sure all the speed control connections are according to the speed control manufacturers specifications. Then go on to the following in the order listed below.

- **Step 1** Make sure the rear wheels are off the ground.
- **Step 2** Turn the transmitter ON.
- **Step 3** If you are using plugs between the battery pack and your speed control, go ahead and connect them now.
- **Step 4** Turn on the ON/OFF switch on the electronic speed control.
- **Step 5** Follow your speed control manufacturers instructions for adjusting your ESC. **Note:** *Most speed controls can now be adjusted with the motor connected. Check to make sure that yours does not need the motor disconnected to make the correct adjustments.*
- **Step 6** Move your steering control on the transmitter (either your stick or your wheel) to the left. Do the front wheels also turn to the left? If not you will have to locate the steering servo reversing switch and move it to the opposite position. Check your radio manual to locate this switch and follow their instructions to change the switch position. Recheck your changes to make sure they are correct so that both the transmitter and wheels move to the left.
- **Step 7** Now we can check the centering on the steering servo saver. Turn the car around so you can see the servo saver facing you. Is the servo saver pointing straight down? If not you can use the steering trim feature on the transmitter to adjust until it does point straight down. If the trim is off by more than a few degrees, you will not be able to solve this problem with the trim feature. To correct, remove the servo saver and rotate the mounting position one spline in the direction you need to go. Now again use the trim feature to center the servo saver.
- **Step 8** With the servo saver correctly centered, see if the wheels are pointing straight ahead? If they are off use the two steering tie-rods to adjust the toe-in/toe-out until you have both wheels pointing straight ahead. This will be 0° of toe-in on both sides.
- **Step 9** Now check the starting diff adjustment. Hold both rear wheels in your hands. Take the thumb and first finger of your right hand and try and rotate the spur gear. The spur gear should be able to move, but with some effort. If it feels too easy to rotate use your 11/32" nut driver or socket to turn the #4185 nylon locknut on the axle clockwise a few degrees. Keep in mind it only takes very small increments on the axle locknut to adjust the diff tension. This will be enough for now until you can try the settings on the surface you will be running on.
- **Step 10** Turn your speed control ON/OFF switch off.
- **Step 11** Now you can turn the transmitter switch off. **Remember: the transmitter switch will always be the first thing turned on and the last thing turned off.**

BODY PAINTING

Your RC12LC does not come with a body. Associated and many other companies make a large selection of bodies that will cover most customer preferences.

TRIMMING THE BODY. The body can be painted before you cut out its holes; however, it will be much easier to locate and cut the mounting holes for the body mounts and antenna tube if you painted after trimming. Trim the sides and cut out the wheel wells. If this is your first attempt, only trim off a little at a time until it clears or fits. Then cut out the mounting holes.

Racer's Tip: Mark the areas you want to cut or trim with a marking pen. Then use an X-acto knife with a new blade to score the lines you just marked. You can then flex the body at the score line and peel off the part you want to remove. Be very careful around any sharp corners to prevent the body from tearing where it is not suppose to.

MASKING THE BODY. Thoroughly clean the body using a mild dish soap and water. Then dry it with paper towels or cotton cloths (something with very little lint). Because you will be painting on the inside of the body, you will need to do all your masking on the inside of the body as well.

Now mask the body off according to your paint scheme. Use automotive masking tape for best results. Take the time to press all edges down with a Popsicle stick or your fingernail. To prevent overspray from getting on the outside of the body, put masking tape on the outside of the body at the body mount and antenna tube holes. When painting Lexan bodies you will always apply the darkest color first and the lightest color last. This prevents the darker color from "ghosting" through to the lighter color. So first mask the section to be painted white. The next color you mask is the next darker color nearest to white, and so on.

PAINTING THE BODY. Now that you have the body masked, it is time to apply the paint. The body is made of Lexan polycarbonate. The paint will be applied to the inside. They make special paints designed just for Lexan bodies. The most common is *Pactra R/C Car Racing Finish* which is available in most hobby shops. There are two different ways to paint the body. You can apply the paint by brushing or spraying it on. Brushing the paint will always leave streaks in the paint, but will look good from a satisfactory distance. Spraying gives you the best looking finish but does require some extra effort and a safe place to apply the paint. You want a well ventilated location and you want to be certain that the overspray will not get on any thing else you own.

Apply the paint in very thin coats, letting the paint dry between coats. **WARNING! If the paint is sprayed on in heavy coats, the paint thinner in the paint will stay liquid and attack the Lexan. The body then becomes brittle and will crack easily.**

Spray your darkest color first and let it dry. Then peel off the next layer of masking tape and apply the next lighter color. Continue with this process until you have applied your lightest color paint. If you do make a mistake, the only product that we have found that can remove the paint without damaging the Lexan is Synthetic Reducer, which can be purchased through a automotive paint supply store.

MOUNTING THE BODY

Every body requires different body mount heights. For the front you can add or subtract washers under the body mounts to raise or lower it. You can also cut the height of the body mount down, but this occurrence would be rare for a 1:12 scale car. For the rear the body mounts are height adjustable. The sides of the body should be slightly below the bottom edge of the chassis.

RC12LC MAINTENANCE

You will find your RC12LC car will give you many hours of trouble-free operation. Even so you should periodically check all the moving parts: front A-arms, steering blocks, steering linkage, pivot balls, and so on for wear, missing or loose parts. Replacing, tightening or cleaning of the parts in questions will greatly improve the performance of your car.

MOTOR TROUBLESHOOTING. Because the car is low to the ground, it is possible to get dirt or debris in your motor. This can cause motor problems. If you are having problems with your motor you will need to check these things first:

1) If the motor does not run at all you should check the wiring connections first. Are all the wires and capacitors connected properly? Are all the solder connections in good shape? A bad solder connection will have dull finish or it will be rounded under the edges. (This means the solder has not properly bonded the parts together.) Pull on the wires to make sure that the connections are really solid.

2) A sticking brush could be caused by dirt or the brush braided wire getting caught or hung up on the brush holder. Either of these can prevent the brush from being able to slide in and out inside the brush holder so that it is making contact with the commutator at all times. You can normally correct either problem by pulling the brush out of the brush holder a very small distance and then letting it snap back into the brush holder from the spring pressure of the brush spring. To prevent these problems in the future you should clean the brushes, holder and commutator. You should also reroute the brush wire over the top of the brush holder and then down into the spring slot on the right side of the brush holder (behind the spring). This way the brush wire cannot get caught or bent over the outer edge of the holder. Always keep in mind that the brushes need to be able to move freely in the brush holder.

3) To check for a shorted motor, you will want to remove the motor pinion from the motor. This will prevent the vehicle from getting away from you or causing any damage. With a fully charged battery pack, turn on the radio transmitter followed by the car. Now give the car full throttle. Does the motor seem to reach full speed? If you are using a high revolution motor, it should sound like it is turning at a very high speed. Next, with the motor still running, place one finger on each side of the motor end bell so that one finger is contacting the positive side and the other is contacting the negative side. We are not trying to make electrical contact, we are just going to be looking for excessive heat. If the motor is shorted it will get extremely hot on one of both sides of the end bell in less than a minute. This means it will become hot enough to burn your finger at the end of the minute. Following the above procedures will help to pre-

vent your losing unnecessary time in being able to enjoy your new car.

MOTOR MAINTENANCE. After every 2 to 3 runs, remove the brushes from the holders and inspect the tips for wear and/or burning. If you notice any excessive wear, replace the brushes with a new pair. To inspect for a burnt tip, look at the side of the brush on the contact end. If it is a burnt blue color, then the lubricant in the brush has been burned away; new brushes should be installed. These are important steps, for worn or burnt brushes can cause irreparable damage to the motor commutator. Changing brushes frequently will help maintain the life of your motor. For stock upright brush motors we recommend our #738 motor brush; for stock laydown brush motors we recommend our #765 or #766 motor brush. For upright brush modified motors we recommend our #737 motor brush. And for laydown brush modified motors use our #760 motor brush. These are off road compounds, giving you excellent motor life and good power, but we do have other compounds for different applications. At the same interval you should carefully clean the motor. One recommended method is to connect the motor to an old partially charged battery pack and, while the motor is running, spray a motor cleaner directly on the brush commutator area. Run the motor for approximately 15 seconds and apply the spray several times for 2 or 3 seconds. Disconnect the motor and spray again, making sure the runoff is clear and clean. If the runoff is still dirty, repeat the spraying action until clean. After completing the cleaning, apply a small amount of lightweight oil to the bushings or bearings for lubrication.

Never over gear your car (large pinion and/or small spur gear). Over gearing can cause excessive heat and can damage or destroy your motor.

SCHOTTKY DIODE. A new development for motors and high frequency electronic speed controls is an add-on device called a Schottky diode. This diode is used by many speed control and motor manufacturers to improve the life and performance of both components. The diode is suppose to keep the braking MOSFETs cooler, improving their performance and making them more consistent. It also helps to reduce the amount of high voltage spikes from the motor that could reach your speed control; these spikes can contribute to premature failure. The reduced spikes also would increase the motor commutator life. Reedy sells a package of two replacement diodes, #745. **WARNING!** *Do not use Schottky diodes with reverse speed controls! The speed control will be damaged! Also, the diodes are polarized, so make sure that you hook positive to positive and negative to negative. If connected backwards, the car will act like it has a shorted motor when the throttle is applied until the diode shorts out.* We also recommend the use of two diodes per motor when running a high power, low wind motor in most vehicles. Because of the new high current motors, the current draw can be enough to overload a single diode.

A full line of Reedy stock and modified motors are listed in the 1/12 scale catalog which should come with your kit. If you did not receive one in your kit you can call or write us, asking for the 1/12 scale catalog, and we will happily send you one at no charge.

RADIO MAINTENANCE. Radio problems are normally the more common problems. But keep in mind that radio problems are caused by many sources to the radio system. Often it is the result of a combination of several factors which can include: motor noise, poor electrical connections, bad wiring layout, reversed or defective crystals, weak transmitter batteries,

and so on. You can also have a very sensitive receiver. If your radio problems persist, one of the following tips may help:

Make sure your motor noise capacitors are properly installed. Most speed control manufacturers now recommend three .1 uFd capacitors per motor.

Make sure the brushes are free in their brush holders and that they are not chipped at the contact edges, which could cause arcing. Replace if necessary.

Try a different motor.

Try a different steering servo.

Try a different radio frequency, (the transmitter and receiver crystals can be loose, damaged or broken).

Try mounting the receiver on its side with the crystal up to get it away from the chassis. Also move it away from the side of the chassis.

Dress the radio wires well away from the power leads from the motor or battery.

Move the antenna wire away from the servo wires, which can generate a signal into the antenna wire.

The new, high frequency speed controls now also generate a low frequency signal which can cause interference with the receiver. Try to keep them at least two inches apart if possible.

If you have one of the new Schottky diodes, make sure that it is soldered on correctly. If soldered on backwards it will make the motor feel like it is shorted out.

Keep in mind that you can also run into outside interference at times, and the 75 mhz radio band will tend to be more susceptible to this problem than the 27 mhz band. Large metal objects such as chain link fences, light poles, cars, vans, trailers or even florescent lights can occasionally cause local interference by momentarily blocking or reflecting or modifying a signal.

DIFFERENTIAL MAINTENANCE. You should rebuild the differential when the action gets somewhat "gritty" feeling. Usually cleaning and applying new lube per instructions will bring it back to new condition. Normally, as the parts seat, the diff will get smoother. If after carefully cleaning and relubing the diff parts the diff still feels gritty, the diff balls and drive rings should be checked and possibly replaced. The standard diff balls and drive rings should be changed any time you cannot get the diff to feel smooth after it was cleaned, lubed, and reassembled.

CLEANING YOUR CAR. You can clean your car with many products Some may also be safe for cleaning electronics parts. Others may be safe for cleaning Lexan bodies. Electronics part cleaners will clean your car, motor and electronics. They are convenient and work very well, but can be expensive. There are also motor cleaning sprays which will clean your car and motor but are harmful to plastics like servo, receiver and speed control cases. Like the electronic cleaners, this works very well, but can cost a lot. To keep your maintenance costs down, you can clean your car (not the motor) with normal household cleaners like 409, Fantastic, Simple Green or similar cleaners. These cleaners have water in them so they are not recommended for use on motors or electronics. Because of the water, you need to help prevent rust on the steel parts (front axles, screws, etc.). This can be accomplished by carefully drying the parts or spraying them with a product like WD40 to seal the surface of the part from moisture (after they have been cleaned) so they will not rust. The rust will not affect the performance of the vehicle only it's appearance. **WARNING!** *Most of these*

cleaners have chemicals in them that will affect the Lexan body. The best way to clean your car body is with warm water and a mild dish soap. Any other products will dry out the Lexan and make it easier for the body to crack.

Associated has recently released our new #711 Reedy Car Wash, which cleans both your car and Lexan body. It is biodegradable and Lexan safe but cannot be used to clean motors or electronics.

TUNING TIPS

CASTER (fig. 102) describes the angle of the kingpin, in relation to the vertical plane, when looked at from the side of the car. As an example, 0° of caster puts the kingpin in a vertical line. Positive caster means the kingpin leans rearward at the top.

Caster has several effects; however, the easiest way to see its effects is to compare it to the casters on the bottom of a shopping cart. When the cart is pushed forward, any misalignment of the casters will cause a side load on the wheels and thus cause the wheels to realign in the direction of travel. Increasing the positive caster on your car will slightly increase the steering turning into a corner and slightly decrease steering coming out of the corner. Reducing the positive caster will decrease the amount of steering you have going into a corner and increase the amount of steering you have in the middle of the corner and exiting the same corner.

Your RC12LC has adjustable caster in increments of 2°. With the 0° upper arm mounts you can have settings of 0°, 2°, and 4° of positive caster as shown. You change the caster by placement of the PTFE caster shims on either side of the upper arm mount. The three drawings below show the locations of the caster shims and what the resulting caster settings will be. The 0° mounts are recommended for oval racing or for a less aggressive steering feel.

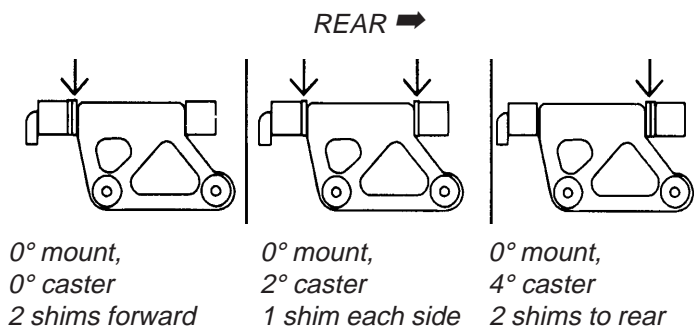

Fig. 102

CASTER CHANGE (fig. 103) has only been used in electric R/C racing for a few years. It is however an important adjustment that is available with our Dynamic Strut front suspension. As was shown in the assembly instructions we have two different sets of upper arm mounts. The 0° mount is level with the chassis when mounted (see fig. 90 above). The 10° mount is angled ten degrees in relation to the chassis or lower suspension arm. This angle provides a change in caster during suspension movement. The caster angle will change two degrees during full suspension travel. Your car will steer more aggressively when using this option. The starting or static caster setting is changed in the same manner using the PTFE caster

shims. Static caster starts at either 2°, 4°, or 6°. A more detailed example would be a starting caster of 2° will have 0° caster at full suspension travel and a starting caster of 6° will be only 4° at full suspension travel. This setup is recommended for road racing applications giving you the most aggressive steering possible.

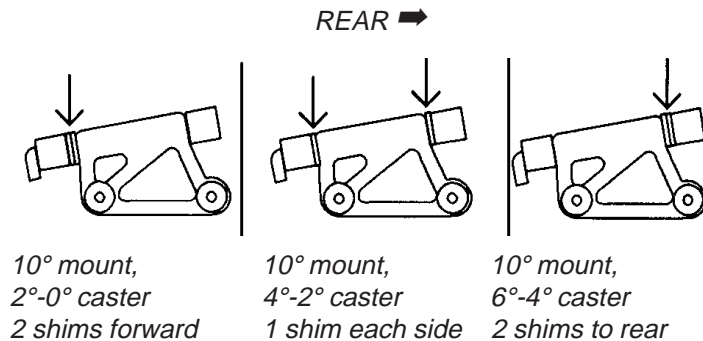

Fig. 103

CAMBER is a word describing the angle at which the tire and wheel rides relative to the ground when looked at from the front or back (fig. 104). This is one of the most important adjustments on the car. Negative camber means that the tire leans inward at the top, putting it closer to the centerline of the car than the bottom of the tire. Positive camber means just the opposite, the top of the tire is further away from the centerline of the car than the bottom of the tire.

Excessive negative camber will decrease traction but increase stability. Positive camber will also decrease traction and decrease stability. A tire's maximum traction is achieved when it is perpendicular to the ground (straight up and down). We suggest a starting setting of 2° of negative camber. If you want to add a little more steering, reduce front camber to 1° negative or even 0°. Keep in mind that using little or 0° of camber can cause the car to be unpredictable. Try to use at least 1 to 2° negative camber at all times. This can be adjusted by turning the upper arm turnbuckles in the appropriate direction. Because the rear axle is a solid axle there is no rear camber adjustment on this car.

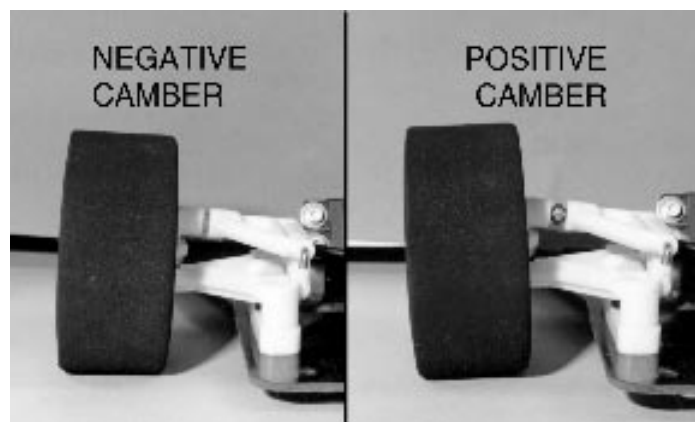

Fig. 104

TOE-IN AND TOE-OUT is a beneficial adjustment and has a fairly significant effect on the car (fig. 105). Toe-in will

help stabilize your car and it also removes a small amount of turn in steering. Toe-out will allow the car to turn in to a corner quicker but will reduce stability exiting the corner. Both toe-in and toe-out will scrub speed so try to use as little, of either, as possible. You adjust the toe-in or toe-out by adjusting the length of the steering tie-rod turnbuckles.

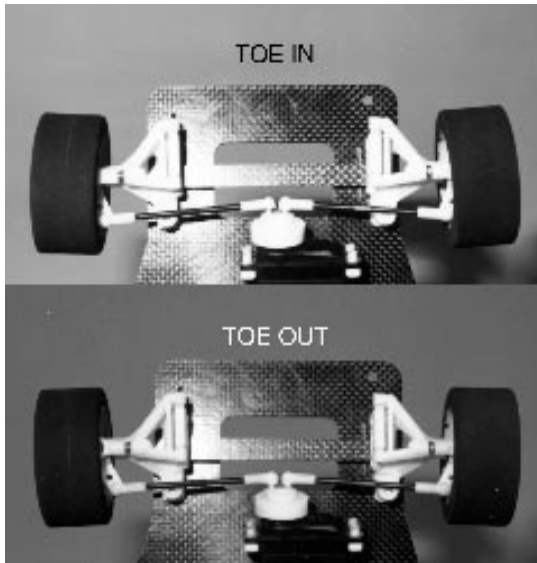

Fig.105

FRONT SUSPENSION SPRINGS are available in various wire sizes as listed below. Changing springs will increase or decrease steering. In general a softer spring (smaller wire diameter) will add steering and a harder spring (larger wire diameter) will decrease steering. Oval racing will normally require a harder spring than road course racing.

PART NUMBER	WIRE SIZE	
#4416	(.024")	<i>Harder</i>
#4417	(.022")	
#4413	(.020")	
#4414	(.018") std. kit.	
#4419	(.016")	
#4418	(.014")	<i>Softer</i>

DAMPENER PLATE SPRING ADJUSTMENTS The spring tension on the two dampener plates is preadjusted for you. If you decide you want to experiment and increase the spring tension you can use Associated #7368 shims. We recommend using the standard tension for most track conditions. The standard setting will make the car very predictable and easy to drive. If you increase the dampener spring tension the car will become much more responsive to steering input and may be more difficult to drive in low traction conditions. It is very important to keep the dampener plates CLEAN and lubed for each race. We recommend using the Associated #6636 diff lube that came with your kit or Green Slime from R/C Performance Specialties.

DAMPENER PLATE ROLL STOP INSERTS, #4518, are included with your kit (figs. 106 and 43). There are two different size roll stops. Each stop will control the amount of roll that the chassis can make during hard cornering. The stop with the smallest side to side opening (in the middle) will reduce the chassis roll the most. This stop insert will make the car change

directions VERY quickly during cornering. The second roll stop insert with a slightly larger opening will have slightly less of this effect. No roll stop insert (which is what we recommend for a starting setting) will be the least aggressive for steering during hard cornering. **WARNING! You must pay very close attention to tire diameter when using either of the roll stop inserts. This is because any difference in tire diameter (side to side) may cause the dampener post to rest against the roll stop insert.**

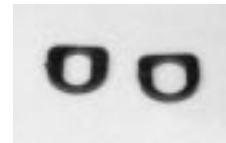

Fig. 106

T-BAR THICKNESS AND FLEX Your RC12LC comes with two T-bars. The #4522 T-bar has a thickness of .063" and the #4520 T-bar is .075" thick. The .063" T-bar is the recommended thickness for low traction conditions. The .075" T-bar is recommended for high traction conditions. If you use the .075" T-bar your car will turn more aggressively but will not be as smooth accelerating through bumps. The .063" T-bar will give the car more rear traction and will seem smoother through bumps. We recommend using the .075" T-bar when racing on smooth carpet tracks with good traction.

Look at the back end of the T-bar at the "T" shaped section. You will see there are three holes which can be used to attach the T-bar to the lower rear pod plate. You have assembled your RC12LC using only the two outer most holes. This setup will make the rear suspension very active (soft) front-to-rear with very little effect on the side to side stiffness. Your RC12LC will have more rear traction and will accelerate through bumps better than if you were using all three attachment holes. This adjustment applies to both the .063" and the .075" T-bars. Try using all three attachment holes when racing on smooth, high traction conditions.

REAR AXLE HEIGHT ADJUSTERS Your car comes with three sets of rear axle height adjuster inserts (fig. 107). These inserts allow you to raise or lower the height of the back of the car without changing tire diameters. Even though there are only three offsets, they can be installed for a total of five different axle heights as shown below.

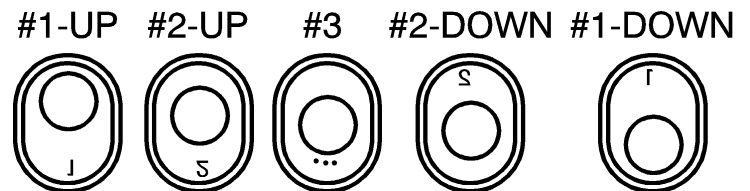

Fig. 107

The #1-up position allows you to use the maximum diameter tire and the #1-down position requires you to use the minimum tire diameter. This adjustment allows you to get more useful life from a set of tires by adjusting axle height as tire diameter decreases. You can also adjust the overall height of your car for high or low traction conditions. For high traction, smooth tracks and four cell racing, try using the #2-down or #1 down positions. For low traction, bumpy tracks and six cell racing try using the #3 #2-up or #1-up positions. These positions will allow you to use a larger tire which will increase traction and make

the car smoother in the bumpy sections.

MOTOR GEARING

You can get the most from your motor with the correct gearing.

STOCK. A recommended starting gear ratio for four cell racing with stock motors would range from about 3.5:1 to 4.2:1. For six cell racing with stock motors the gear ratio would range from 4.0:1 to 4.75:1. This is based on using a full diameter (or new) tire. Your gear ratios will also be influenced by the type of stock motor plus factors such as your track's length, traction, surface composition; tight or open track; and your car's rear tire diameter. A basic 24° stock motor would start normally at the low end of the gearing range (3.5:1 for four cell or 4.0:1 for six cell). While a 36° to 40° short stack stock would normally have a starting gear ratio of 4.2:1 (for four cell) or 4.75:1 (for six cell).

If you are not familiar with determining gear ratios and tire diameter adjustments, then the formulas that follow this section will assist you.

MODIFIED. For modified racing there are different motors used for outdoor (asphalt) and indoor (carpet) as well as six cell and four cell. With the current technology in batteries for six cell racing our team is using 14 or 15 turn motors on large asphalt tracks or 15 or 16 turn motors on carpet tracks. For four cell carpet racing we use 12 to 14 turn motors depending upon track size and layout. For six cell racing the gear ratio would range from 4.5:1 to 5.3:1. For four cell racing the gear ratio would range from 4.2:1 to 5.0:1. The lower the wind of the motor the higher the starting gear ratio should be.

Formulas

Determining the gear ratio. If you already have a pinion gear and spur gear you can calculate the gear ratio as follows: *Examples: Spur gear = 78, pinion = 17*

$$\begin{array}{r} \text{Spur} \quad \text{Pinion} \quad \text{Results} \quad \text{Gear} \\ \text{Gear} \quad \text{Gear} \quad \quad \quad \text{Ratio} \\ (78 \div 17) = 4.59 = 4.59:1 \end{array}$$

Determining pinion size based on a given gear ratio. *How to determine starting pinion size based on a recommended gear ratio and chosen spur gear size. Examples: Spur gear = 78, pinion gear ratio = 4.30:1*

$$\begin{array}{r} \text{Spur} \quad \text{Gear} \quad \quad \text{Results} \quad \text{Gear} \\ \text{Gear} \quad \text{Ratio} \quad \quad \quad \text{Size} \\ (78 \div 4.3) = 18.139 = 18 \text{ (always round to nearest whole number).} \end{array}$$

If your results are not close to a whole number (example 18.652) you can get closer to the actual gear ratio by trying different size spur gears.

Tire diameter adjustment. *If you change tire diameter you can affect your gearing. You can calculate any gearing adjustments by using the following formula.*

$$\begin{array}{r} \text{Old} \quad \text{New} \\ \text{Tire} \quad \text{Tire} \quad \text{Factor} \\ \text{Dia.} \quad \text{Dia.} \\ (2.1" + 1.9") = 1.105 \end{array}$$

$$\begin{array}{r} \text{Old Pinion} \quad \text{Factor} \quad \quad \text{Results} \quad \text{New Pinion} \\ \text{Gear} \quad \quad \quad \quad \quad \quad \quad \quad \quad \text{Gear} \\ 18 \times 1.105 = 19.89 = 20 \text{ (round to nearest whole number)} \end{array}$$

BATTERY CHARGING

It is important to understand the characteristics of the battery pack in your car. How you charge and use your packs will greatly affect both its performance and its life span. With proper care your packs will perform well for many hundreds of cycles.

The ROAR legal battery for use with your car is composed of four or six "sub-C" size cells with a rated capacity of between 1.2-1.8 amperes for one hour, or 2.4-3.6 amperes for 1/2 hour, etc. This charge capacity is the same regardless of the number of cells in the pack because the cells are connected in series and the same current passes through each one.

CHARGER. A good quality automatic charger will last longer than an economy unit, so please do not cut yourself short here by trying to save a couple of dollars. Any good name brand charger will do the job correctly. **Associated recommends a peak detection charger as opposed to the timer charger.** Timer chargers increase the chance of making a mistake when charging the battery. This also increases the chance of damaging the battery pack. Peak detection chargers have an internal circuit that monitors the voltage and charge rate of the battery pack. When the pack is fully charged, the voltage will begin to decrease and a peak charger will detect this and either turn the charger off, or down to a trickle charge. Some chargers have even more sophisticated features that make charging less time-consuming. The better chargers like this can easily handle the abuse of heavy back-to-back type charging that is common when racing or playing for a long time. The choice of a DC only or an AC/DC charger should be based on personal needs (where you will be using your car, etc..) and usage.

OVERCHARGE. There is no way to make a Ni-Cd cell accept more charge than it is designed to hold. This means that as the cell approaches a fully charged condition, the portion of charging current not being stored becomes heat and pressure. If charging continues after the cell is fully charged, all of the current is converted to heat and pressure—about 40 watts worth, or the equivalent of the heat produced by an average soldering iron. High temperature and pressure is damaging to the cells, so overcharging must be avoided.

Ni-Cd cells have a built-in process for recombining the accumulated gas (actually oxygen) produced by overcharge, but the process produces heat and takes a lot of time. If you overcharge your battery and it seems to take a long time to cool down, it's because this pressure reducing reaction is taking place. Once the gas is recombined the temperature drops.

HOW TO TELL WHEN YOUR CELLS ARE CHARGED

One of the problems with Ni-Cds is their inherent voltage stability; the voltage of a fully charged cell is not much different from one that's just about dead. For that reason several indicators, along with some common sense, are needed in order to get the most out of your battery. The following is a list of indicators you can use to detect full charge.

SLOW CHARGE METHOD. Slow or "overnight" charging is a method you are not likely to use often, but it is a good way to bring the pack to absolutely full charge. However, the output voltage of a slow charged pack is slightly lower.

The charging current must be between 0.05 and 0.12 amperes. If less current, the pack will never reach full charge; any more and the pack will overheat. The time required to reach full charge ranges from 15 to 40 hours, depending on the current used. The charger can be left on for a much longer time without harming the cells; however, the output voltage of the pack will be temporarily lowered by an extremely long overcharge. The voltage returns to normal after a discharge-charge cycle.

These next two tips are for the benefit of serious racers. If you're just out having fun, don't worry about them.

FULL DISCHARGE. Ni-Cd packs perform best if they are COMPLETELY discharged before they are charged. If you are involved in racing, you will have to do this if you expect to win any races! Discharge for at least an hour (preferably overnight with a clip-on resistor) before charging.

TOPPING-UP can give you a little extra voltage at the beginning of a race, as long as you don't overdo it. Put the last minute or two of charge into your pack just before the race starts.

GOOD LUCK IN YOUR RACING!



CAUTION

Ni-cad batteries are susceptible to damage when over-

charged at a high rate, and can release caustic chemicals if the overcharge is severe.

Do not stall the motor under power. If the car stops suddenly on the track, or fails to move forward when you attempt to accelerate, push the throttle control on your transmitter to the brake position immediately and attend to the car. A small rock can stall the gears, and if the throttle is left in the on position the result can be a burned out motor (or electronic speed control unit).

If you run your car to the point where more than one cell in the pack is completely discharged, it is possible to lose radio control of the car before the drive motor stops completely. For this reason you should not operate your car in an area where it could be harmed or cause harm, such as near a busy roadway or a pool of water. Usually radio control will be regained as soon as you pick up the car and the motor is allowed to free-run. If you still don't have control, then you should unplug the motor.

When you stop running your car, turn off the radio **at the car first before** turning off the transmitter.

A burned-out or shorted motor can make the car appear to have radio problems. If the car slows down suddenly and the radio acts erratically even with a full battery charge, then the cause is probably the motor. Check the range of the radio with the motor unplugged. A shorted motor will draw extremely high current even under no-load conditions.

**SAVE THIS BOOKLET!
ITS MORE THAN AN INSTRUCTION
MANUAL, IT'S ALSO A HANDY, PICTO-
RIAL SUPPLEMENT TO TEAM
ASSOCIATED'S 1:12 SCALE CATALOG.
REFER TO THIS MANUAL FOR
PART NUMBER AND NAME WHEN OR-
DERING.**