

DUAL SPORT INSTRUCTION MANUAL

Associated Electrics, Inc., 3585 Cadillac Ave., Costa Mesa, CA 92626

RC10

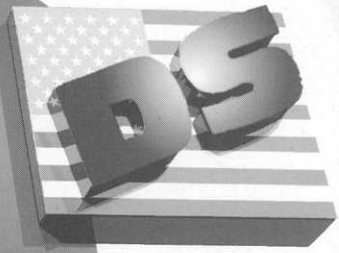

DUAL SPORT



DO NOT DISCARD THIS MANUAL!

Use with current catalog for future,
hassle-free re-ordering of parts

ASSOCIATED ELECTRICS, INC.

AE TEAM ASSOCIATED

MOLDED COMPOSITE SHOCK TOWER

**STEALTH TRANSMISSION
WITH ATC SLIPPER**

**ADJUSTABLE REAR
ANTI-ROLL BAR**

RC10 DS

DUAL SPORT

**MOLDED SUPER-STIFFER COMPOSITE
SUSPENSION ARM, FRONT AND REAR**

**ADJUSTABLE FRONT
ANTI-ROLL BAR**

ADJUSTABLE REAR TOE IN

BLACK ANODIZED ALUMINUM TUB CHASSIS

SCALE BBS STYLE, CHROMED FRONT AND REAR WHEELS

**PROLINE M2 COMPOUND SCALE RACING
TIRES WITH FOAM INSERTS**

**ADJUSTABLE
SERVO SAVER
BELLCRANK STEERING**

**LOW KICK-UP ANGLE FOR
SUPERIOR STEERING RESPONSE**

HIGH IMPACT FRONT BUMPER

ADJUSTABLE HEIGHT BODY MOUNTS

22 TEAM ASSOCIATED



CONCERNING YOUR NEW RC10DS

We congratulate you on purchasing the RC10DS Dual Sport kit. It's a unique and fun vehicle that is based on the most durable and proven car on the market, the original RC10. It does not matter if you have the complete kit or one of the conversion kits (that converts your RC10 or RC10T to the DS), you will find the RC10DS to be a fun, easy-to-drive and competitive car. The feature that makes our car different from our competitor's is the dual sport aspect. This means we are offering two different styles of bodies, for German DTM touring, or IMSA Trans Am racing.

The kits come with our race proven Stealth transmission, Associated's improved shocks, special ProLine semi-pneumatic rubber on road tires with new scale chrome wheels (with BBS style hub caps), and our special dual sport suspension parts.

Our two bushing kit sport versions include a mechanical speed control, stock motor, bronze bushings, and one of two body styles.

The racing version has ball bearings, hard anodized Teflon sealed shocks, and universal dogbone rear axles, but does not include a body, motor or speed control.

In addition to the above, the RC10DS features: new front and rear suspension arms, front and rear anti-roll bars, front and rear shock struts, new body mounts, new chassis nose plate, and aluminum tub chassis.

Many racers have older RC10's or RC10T's that are used less often because they have switched to our RC10B2 or RC10T2. Some may also just be looking for something different to run. The RC10DS conversion kit allows you to convert to on road racing by using your existing off road RC10 or RC10T chassis, your Stealth tranny (or even your original RC10 tranny) and a few other parts from your old car. (You cannot convert from an RC10B2 or RC10T2.)

All of this combines to make one of the most versatile and enjoyable cars we have ever produced. When you are finished you will find what 12 years of Associated off road history has done for your hobby enjoyment.

PLEASE READ THIS BEFORE YOU BEGIN

Our instruction manuals have been considered some of the best in the industry by both hobbyists and R/C magazine reviewers. Many of our customers will feel they can build their kit from the photos alone. This is not true. In addition to the detail in the photos you will find important assembly information. While you have one of our top quality kits the only way to have an assembled car of top quality is to follow **the instructions as well as the photos.**

Step 1 OPEN EACH PARTS BAG WHEN THE INSTRUCTIONS INDICATE, NOT BEFORE. This is to prevent parts from one bag getting mixed up with parts from another bag and helps

make the assembly easier. Check the parts bags against the parts list elsewhere in your kit. Many of your parts bags are numbered or named to help you match it to the appropriate section on the parts list or in the manual steps. Any bags inside a labeled or numbered bag will share the same parts bag name or number as the one it came out of.

Step 2 CHECK EACH BAG FOR SUPPLEMENTARY SHEETS. Because Associated is always working on new ideas for designs or materials to improve our products, we will occasionally make updates or changes to our kits. These changes usually don't appear in the manual because they were not available when the manual was printed. **1)** Inspect each bag upon opening it for the first time. Look for any sheets that indicate changes made to the kit. **2)** When you find one, locate the section of the manual and parts list where this change applies. Use the supplement or update sheet to mark any changes to a parts bag inventory list and then **3)** secure the supplementary sheet to the appropriate step in the manual. This will guarantee that you have the information concerning the change when you begin this step and will save time so that you are not looking for the wrong part in the parts bag.

Step 3 KEEP YOUR PARTS SEPARATE. While building your car it will be necessary to have more than one parts bag open at a time. In order to prevent confusion we recommend using large paper plates (especially picnic plates with partitions) to keep the parts from each bag spread out so that you can find them easily. Mark each plate with bag numbers before you place the parts in them. When you have used all the parts from a bag you can then relabel the plate so that it can be used for another bag.

Step 4 ADDITIONAL ITEMS NEEDED TO OPERATE YOUR CAR:

- 2 Channel R/C surface frequency radio system. (Bushing kits require two servos but ball bearing kits require only one servo)
- Battery pack (6 cell)
- Battery charger (we recommend the use of a peak detection charger)

THE FOLLOWING ADDITIONAL ITEMS ARE NEEDED IF YOU HAVE A BALL BEARING TEAM KIT:

- Electronic Speed Control (also know as an ESC)
- R/C electric motor
- Pinion Gear (48 pitch); size to be determined by type and wind of motor you will be using.

Step 5 TOOLS. This kit contains the shock/turnbuckle wrench and the four Allen wrenches you will need to assemble your car. You will need to supply the following tools and adhesives:

- Phillips screwdriver, #2 tip (#SP-76)
- 1/8" straight blade screwdriver, for bushing kits only
- Needlenose pliers
- Hobby knife, such as an X-acto© knife with a #11 pointed blade.
- Soldering iron (40 to 50 watts), and a small amount of rosin (**not acid**) core 60/40 solder. We have found from experience

that a pencil type soldering iron works better than the more common soldering guns. While the guns generate a lot of heat, they have a hard time keeping the heat at the tip.

Super glue (cyanoacrylic glue) with safety gloves and goggles

Your kit can be assembled easier and faster with the following Associated tools or their equivalents:

Allen drivers (straight Allen wrenches with hex shaped aluminum handles), such as the following by Associated:

#6957 .050"

#6958 1/16"

#6959 5/64"

#6960 3/32"

#6961 2.5mm

3/16" nut driver will make installing the S.S. ball ends and small pattern 4-40 nuts easier (#SP-86).

1/4" nut driver will speed up installing the 1/4" locknuts and front wheel nuts (#SP-85).

11/32" nut driver will speed up installing the 8-32 rear axle nuts (#SP-82).

Precision steel rule (optional), Vernier or dial calipers (with decimal or metric measure).

WARNING!! Do not use a power screw driver to install screws into plastic, nylon or composite parts. The rotation speed is too fast, causing the screws to heat up when being installed into these materials and they can strip out or break.

Final Notes: (1) Experienced builders or racers: **please build the car according to the instructions first!!** The DS is a remarkably fast car right out of the box. There is a good reason for everything on the car. Build it according to the instructions first. Then you will have a solid performance base to use as a comparison for when you do make changes; then you can check where you are gaining or losing performance. (2) At the beginning of each step you will find a box (). When you have finished that step put a check mark in the box. When you stop for any reason during assembly it will be easier to find where you need to continue from.

(3) Occasionally an actual size drawing will accompany the photo to help you identify certain parts. You can place the part on top of the drawing to be sure you have picked up the right one. Also you will most likely end up with some extra parts and fasteners, so do not worry. **WARNING! Only the drawings at the bottom of the photos are to true scale. None of the photos are actual size. Even though you may see dimensions marked in the photos, the photos are still not to scale or actual size.**

(4) The following types of special instructions, in *oblique*, will be used throughout the manual:

● **Racer's Tip:** This is a trick used by some of the Team Drivers to improve their car's handling, performance and maintenance.

● **Note:** Alternate ways to assemble the kit, including tips for smoothing out difficult assemblies.

● **WARNING!** This alerts you to be careful in order to prevent damaging the parts, and warns against using wrong parts or doing an incorrect assembly that could damage or reduce the parts' performance.

SAVE THIS MANUAL! This is more than an instruction manual. It is also a handy supplement to the Associated RC10DS

parts catalog. You can use the manual photos to help you identify part numbers and part names when ordering parts. *In addition, the manual can be used during a technical assistance call to the factory if you are having assembly problems or have any questions. Contact Customer Service at 714-850-9342.* Please remember, it's not a race to see how fast you can put this car together; rather, it's how well you put this car together that will determine how well you race. **DON'T RUSH. TAKE YOUR TIME.**

Now clear off your workbench, line up some paper plates, grab a drink and sandwich, and let's begin!

FRONT END ASSEMBLY

Fig. 1 Before we start to assemble the front end, remove the #8416 shock/turnbuckle wrench and the #6950 tool bag (which contains the four Allen wrenches) from the kit master bag. Set them aside for now; we will be using these as we go through the assembly.

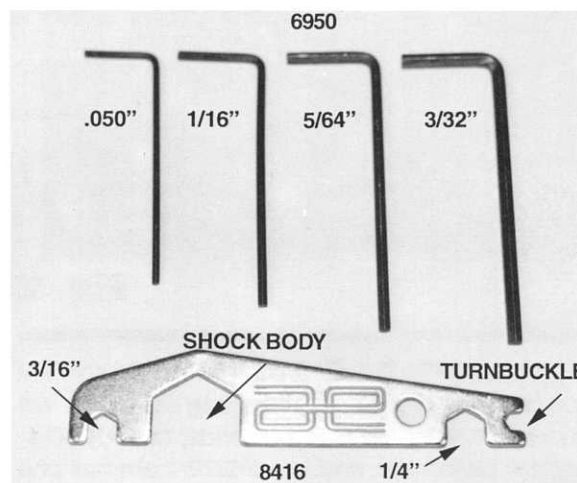

Fig. 1

Fig. 2 Now let's start by opening bag #8-1 and #8-14. 1) From bag #8-1 remove the #6210 30° caster front carrier blocks. Both the right and left carrier blocks are connected as shown in fig. 2. 2) Use your X-acto® knife to separate the blocks and carefully trim off all the runner material and between the two steering block mounts. **WARNING! Any flashing material remaining between the two kingpin mounting points can cause the steering to bind.**

3) Now you will need to remove two #6273 long S.S. ball ends, two #7260 4-40 small thin plain nuts, and the #6272 foam strip from bag #8-14.

4) Lay out your carrier blocks as shown in the middle part of fig. 2. If you have trouble seeing the difference, there is a "L" and an "R" scribed into the long side of each carrier block. 5) Thread the #6273 long ball end into each carrier block from the outside, as it shows in the photo. There is a 3/16" wrench area on the #8416 shock turnbuckle wrench which you can use to install all of the ball ends or the 4-40 small thin plain nuts. **Note:** You can also use your needlenose pliers, but if you want to speed up the assembly we suggest that you use a 3/16" nut driver (Associated #SP-86) or socket. If you use a socket use a screwdriver style handle, not a ratchet handle. 6) After you have

installed the #6273 long ball end thread on the #7260 4-40 nuts and tighten.

7) Fourteen small donut shapes are cut into the #6272 foam strip. We call these ball end dust covers. Remove two of the covers and push the center hole over the ball portion of the #6273 ball end. These help keep the dirt out of the ball end cups, reducing the wear that normally occurs when dirt gets inside.

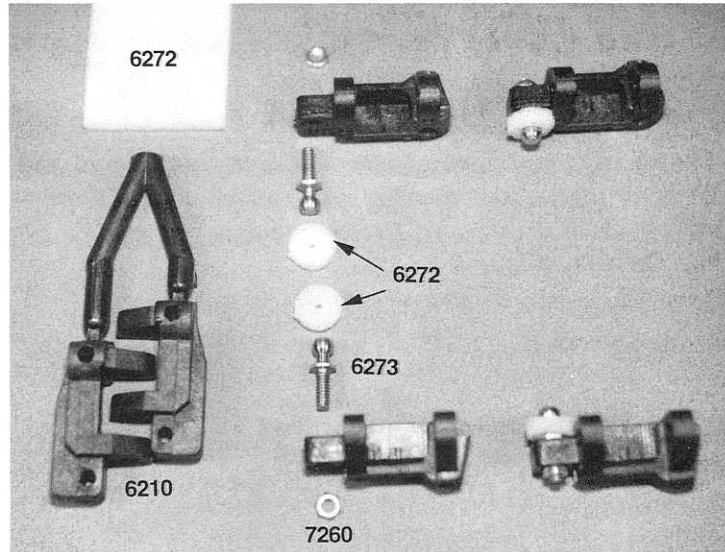
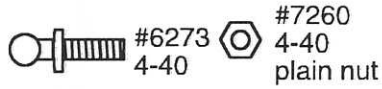

Fig. 2

□ **Fig. 3** 1) Going back to bag #8-1 we will now remove the two #6221 nylon steering blocks. 2) From bag #8-14 we will need to remove two #6270 short S.S. ball ends, two #7260 4-40 small thin pattern plain nuts, and two #6272 foam ball end dust covers. The #6221 steering blocks will be the same until we install the ball ends, then there will be a right and left side. 3) Thread one #6270 ball end into each steering block, but on opposite sides. 4) Now thread on the two 4-40 nuts and tighten them down. 5) Now install two of the foam ball end dust covers over the balls the same as we did in fig. 2. When you are done, your steering blocks will look like fig. 3 and you will now have a left and right steering block. 6) Place the rest of the dust covers aside, for the moment, with bag #8-14; we will use them later in other parts of the manual.

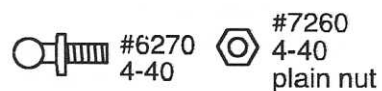
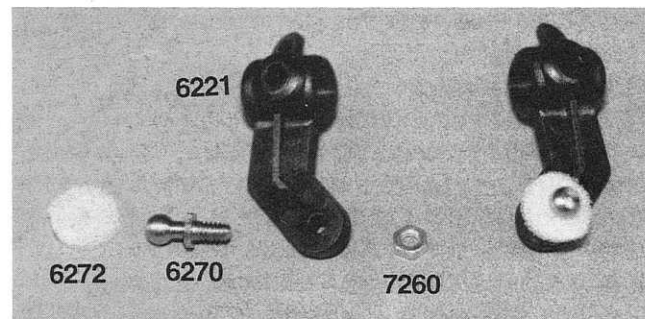

Fig. 3

□ **Fig. 4** 1) In bag #8-1 you will find two #6220 aluminum inline front axles. The hole drilled in the axle is for the steel kingpin which you will install in a couple of steps. 2) In order to install the kingpin easily, use your X-acto© knife to deburr and bevel the outer edge of both sides of the hole.

3) Now we want to take one axle and fit it into one of the steering blocks. Do one axle, then the other. Make sure the hole in the axle lines up with the hole in the steering block. The parts should push together with your fingers with firm pressure; if they do not, then you may fit a 3/16" nut driver over the threaded end of the axle and use the driver to push it all the way in. **WARNING!! The threads on the end of the axle are aluminum and can be easily damaged by the nut driver.** The axle will be fairly tight in the steering block so try hard to align the two holes as you are assembling the parts. **WARNING!! Do not use pliers on the bearing surface of the axle, for this can damage the axle surface so that the bearings will no longer fit.** A small part of the large diameter of the axle will be exposed outside the steering block. This is okay; just make sure the holes line up.

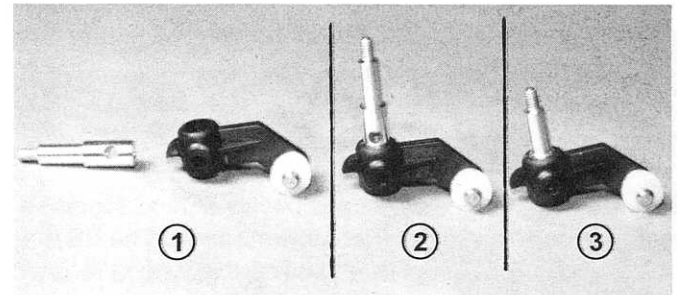

Fig. 4

□ **Fig. 5** 1) Remove two of the #6223 steel pins from bag #8-1. You will find two different lengths of steel pins in this bag. 2) Match the proper pins against the actual size drawing below. Because the #6223 pins are heat treated they will be darker in color than the other pins in the bag. These two pins will become our kingpins. 3) Now check to make sure that both kingpins will go through the steering blocks and axles. If you do not do this now, it will be almost impossible to get the kingpin to go through the #6210 front carrier block and the steering block/axle assembly in the next step. 4) Once you have checked the alignment and fit, remove the kingpins so we are ready for the next step.

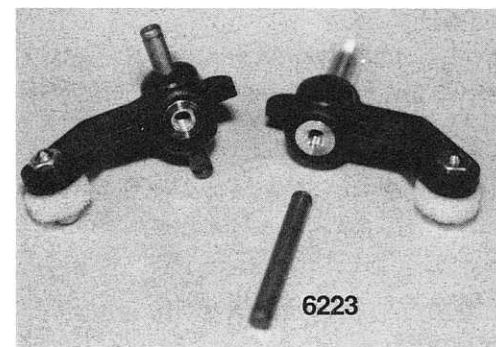
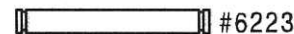

Fig. 5

□ **Figs. 6, 7 & 8** Now we are going to install the steering block/axle assemblies into the carrier blocks. **1)** If you look closely at the front of the carrier blocks you will see the "R" and "L" that are scribed into them. **2)** Look back at fig. 3 and install the left steering block into the left carrier block, then do the same for the right side blocks. Make sure that the ball ends on the assembly will be on the same side (in this case both facing up). **3)** Now reinstall the two kingpins into each assembly as shown in fig. 6.

4) In fig. 7 we are going to install the #6299 E-clips. In this photo you will see the roll of E-clips along with two individual clips to give you a size comparison. As you can see, the clips are not much bigger than the steel pins they fit onto. In fig. 8 you will see an enlarged view of the roll of E-clips and a single E-clip. The roll is held together with white tape that goes most of the way around the E-clips. **The roll is so small and so easy to miss that you should look for the white tape instead of the actual E-clips.** Take out four E-clips. **5)** Install one onto each end of both kingpins. Try to center the kingpins, for this will make the installation of the E-clips easier. We will use the remaining E-clips in the following steps. **Note: If you lose to many during assembly of this section you will find more in the shock seal bag (inside the shock master bag) and the rear end bag #8-8.** **6)** Place the rest of the E-clips back in the bag we will use them in a few minutes.

#6299
 e-clip
 1/8 shaft

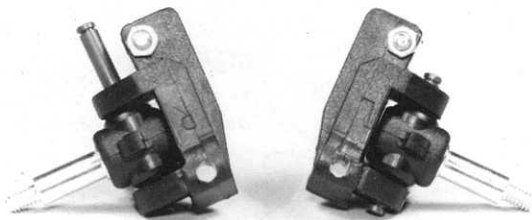

Fig. 6

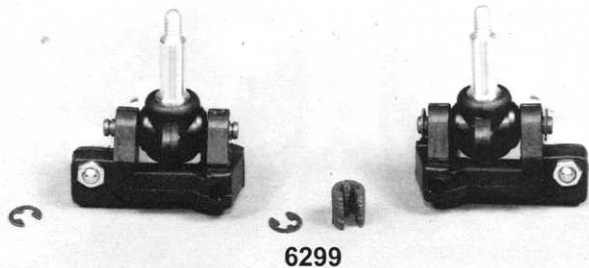



Fig. 7



Fig. 8

□ **Fig. 9** **1)** Look into bag #8-1 again and take out the two #6951 4-40 x 1/8" socket set screws. **2)** Now we need to open up the #6950 tool bag we took out in fig. 1. Inside you will find four different size "L" shaped Allen wrenches. The smallest one will be the .050" Allen wrench which we need for this step. **Note: An Associated #6957 .050" Allen driver or similar driver would make this assembly easier and quicker.** **3)** If you rotate the steering block in the carrier block so that the two ball end are as far apart as possible, then it will expose the back side of the axle which has a small threaded hole in it. Use your .050" Allen wrench to install a set screw into each axle, then **4)** tighten the set screw against the kingpin. **5)** Make sure the steering block pivots smoothly inside each of the carrier blocks.

#6951
 set screw

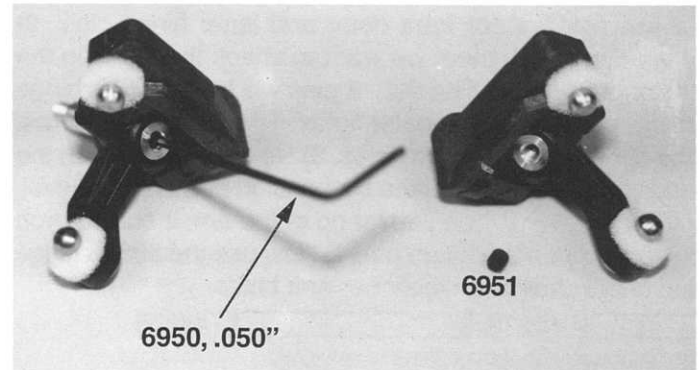

Fig. 9

□ **Figs. 10 & 11** **1)** Remove the two #8810 molded front suspension a-arms, two #8834 front arm shock mounts and two #6918 4-40 x 1/2" button head socket screws from bag #8-1. (One arm and shock mount will be attached to the same runner, so there will be two sets because the arms and mounts are interchangeable--left or right side--until we fasten the shock mounts in place.) **2)** Trim the arms and mounts from the runners in the locations shown. **3)** Place the shock mount on top of the left arm into the recess in the arm, making sure the angled side of the mount is on the inside of the arm. **4)** Now turn the arm upside down and thread in the 4-40 button head screw with the 1/16" Allen wrench (second smallest) from your #6950 tool bag. **Note: An Associated #6958 1/16" Allen driver or similar driver would make this assembly easier and quicker.** **5)** Assemble the right arm the same way. The arms will be mirror images of each other.

#6918
 4-40 x 1/2



Fig. 10

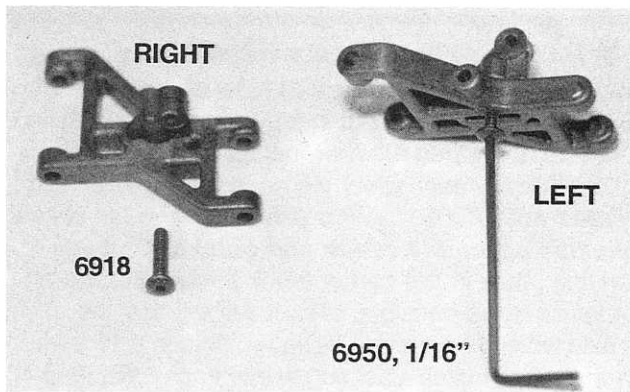

Fig. 11

□ **Fig. 12** 1) Now we need the two remaining #6223 steel pins (heat treated) and the two #8825 steel pins. We will be using these pins as our front outer and inner hinge pins. 2) Before we can install them we want to check the pin fit in the suspension arm holes. The #6223 pins will be the outer hinge pins, so check their fit in the outer holes of the suspension arms. Slide the pin through the arm holes. 3) Now hold the pin on the ends and lift the other end of the suspension arm until it is level, as shown in fig. 12. When you let go of the arm it should drop and swing freely on the hinge pin. 4) Now use the #8825 hinge pins and check their fit on the inner arm holes.

□ #6223 □ #8825

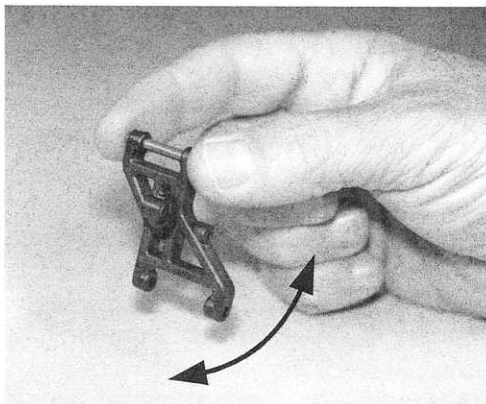

Fig. 12

□ **Fig. 13** 1) Now we need to remove four of the #6299 E-clips we put back in bag #8-1. We are now going to attach the front axle assembly to the front suspension arm. The shock mount will be on the front side of the arm and we will want the front of the axle assembly on the same side. 2) We will start with the left side. Use the block carrier with the "L" scribed into the front. Take one of the #6223 hardened steel pins and slide it through the rear hole of the suspension arm, then the axle block carrier, and finally through the front hole of the suspension arm. We want the pin to be tight when going through the axle block carrier, but not the arm. 3) Now center the pin and install a E-clip onto each end of the pin. 4) Repeat the above steps for the right arm and axle block carrier. Remember to keep the "R" to the front of the arm. Fig. 19 shows both front arms with the axle block carrier assemblies installed.

□ #6223 □ #6299 e-clip 1/8 shaft

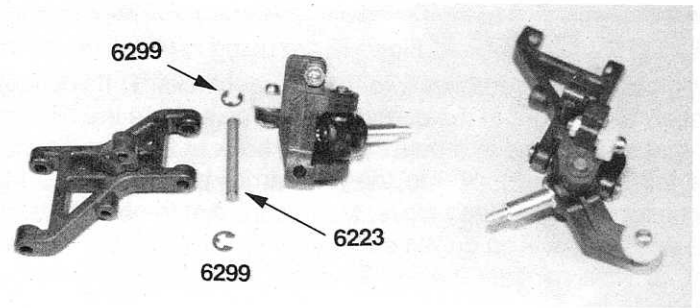

Fig. 13

□ **Fig. 14 & 15** 1) In the same bag #8-1 you will find the #8824 front bulkhead blocks, the #7208 aluminum front bulkhead support, and the last four #6299 1/8" E-clips (it's okay if you have extras). There is both a left and right bulkhead block. 2) Line up the left bulkhead with the left arm inner mounting holes. 3) Now do the same for the right bulkhead and arm. 4) The #7208 front end brace will go in front of the bulkhead but behind both front arm inner mounting holes. Place the block between the inner mounting holes of the arm. 5) Now slide the #8825 front inner hinge pins (we took these out in fig. 12) through the back arm hole, the bulkhead, the aluminum front brace, and out through the front arm mounting hole. 6) Now center the hinge pins and install a E-clip onto each end of each pin. Fig. 15 shows both arms and bulkheads assembled.

□ #6299 e-clip 1/8 shaft □ #8825

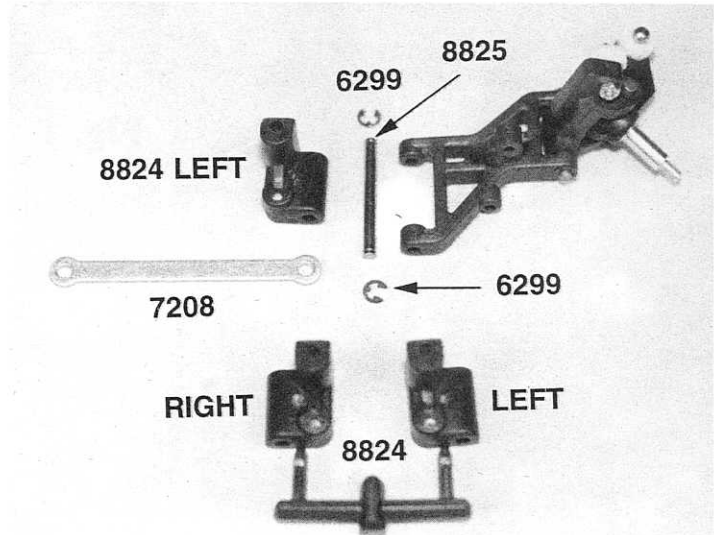

Fig. 14

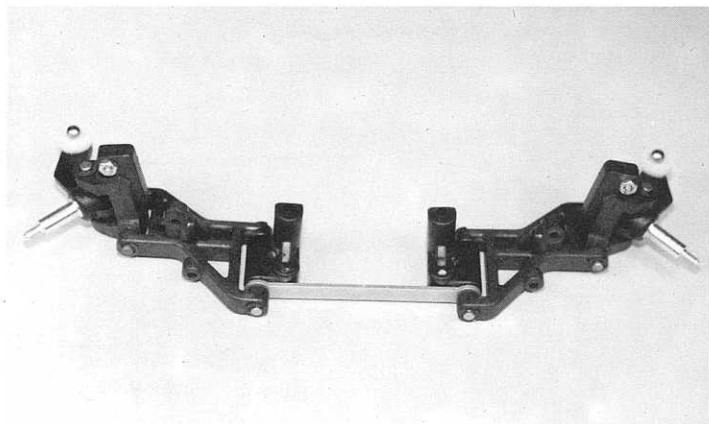

Fig. 15

□ **Figs. 16 & 17** 1) Remove the #8832 fiberglass front shock strut from bag #8-1. 2) Now go back to bag #8-14 and remove two #6270 short ball ends, two #7260 small 4-40 plain nuts, and two #6272 foam ball end dust covers. 3) Layout your strut so that the long flat side matches the photo. This will be the bottom of the shock strut. 4) On the sides of the front shock strut you will see two holes. Install the ball ends into the lower hole as shown. 5) Now, thread the 4-40 nut onto the end of the threads on the other side of the shock strut. 6) Now install the foam ball end dust covers over the ball ends.

7) Next remove two #6924 4-40 x 3/8" socket head cap screws from bag #8-1. 8) The ball ends will be on the back side of the front shock strut. Line up the strut with the two mounting holes in the back of the front bulkhead blocks. Use the 3/32" Allen wrench (the largest in the tool bag) to fasten the front shock strut to the bulkhead with the two #6924 screws. *Note: An Associated #6960 3/32" Allen driver, or similar driver, would make this assembly easier and quicker.*

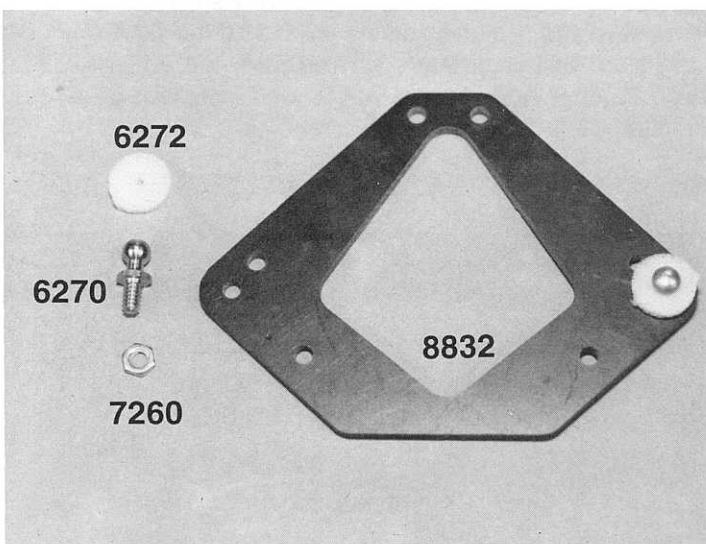
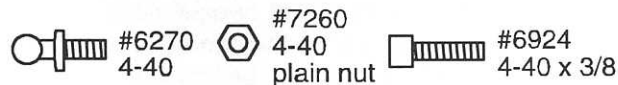

Fig. 16

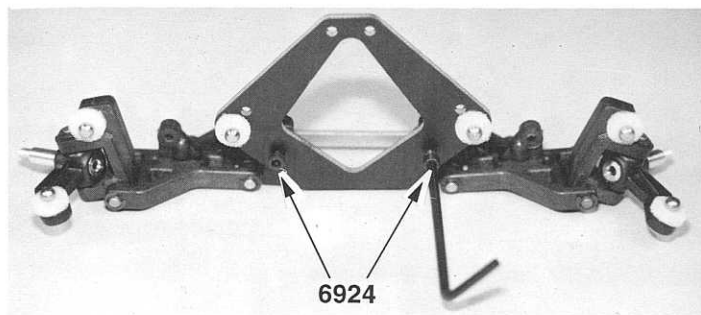

Fig. 17

Figs. 18 & 19 1) In bag #8-1 you will find the two #8812 turnbuckles. 2) Now go to bag #8-14 and remove four of the #6274 plastic ball end cups. (There are a total of 14 ball end cups on the molded parts tree, as shown in the photo.) When assembled these will become the front camber links. We suggest you read instruction figs. 18-19 all the way through before beginning. 3) Now we want to thread the ball end cups onto the turnbuckles. The best way to do this is to hold the center of the turnbuckle with the #8416 shock/turnbuckle wrench. 4) The turnbuckles have left hand threads on one end and right hand threads on the other, so the cups will screw on in different directions. (This feature helps to simplify adjusting camber. After it is installed, you can turn the turnbuckle with the wrench to lengthen or shorten the camber rod without removing it.)

Install both ball end cups as evenly as you can. 5) Finish the installation by using the smooth part of your needlenose pliers to hold the cup still and the use the #8416 wrench to turn the turnbuckle. **Racer's Tip: To prevent damaging the ball end cup, rotate only the turnbuckle, not the ball cup. Turning the ball cup will likely damage it.**

6) Thread the cups on until you reach a length of 1 9/32" (1.28" or 32.5mm) **THESE DIMENSIONS ARE MEASURED TO THE CENTERS OF THE BALL CUP SOCKETS, NOT THE ENDS OF THE SOCKETS**, as shown in the scale drawing below. When assembled and adjusted correctly both ball end cups will be facing the same direction. 7) Now look at fig. 19 and use your needlenose pliers to snap the turnbuckle ball end cups onto the four ball ends.

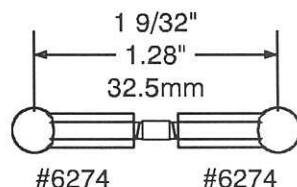

Fig. 18

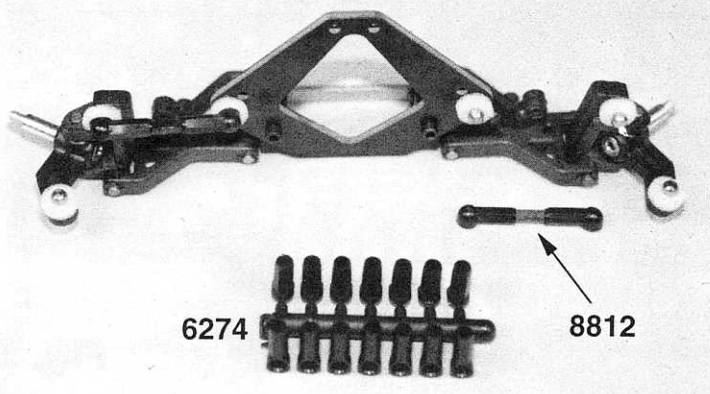

Fig. 19

□ **Fig. 20** The plastic ball end cups can be removed from the S.S. ball ends by holding the cups next to the ball with your needlenose pliers and twisting the cup off of the ball end.

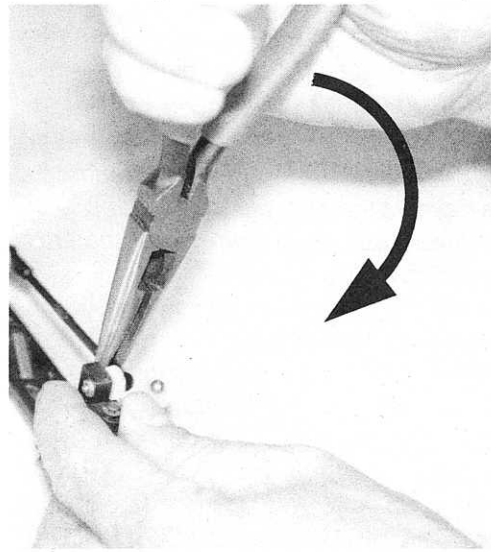



Fig. 20

□ **Fig. 21** 1) Go back to bag #8-1 and remove the #8820 front aluminum kick up and four #6292 4-40 x 3/8" flat head socket screw. 2) We are now going to attach the front bulkhead to the aluminum kick up. Place the front end over the kick up, then holding both parts, turn them over. 3) On the bottom side you will find four countersunk holes. Locate the bulkhead over the four holes and then thread the #6292 screws into the four holes with your 1/16" Allen wrench. 4) After all four screws have been installed, go ahead and tighten them down.

 #6292
4-40 x 3/8

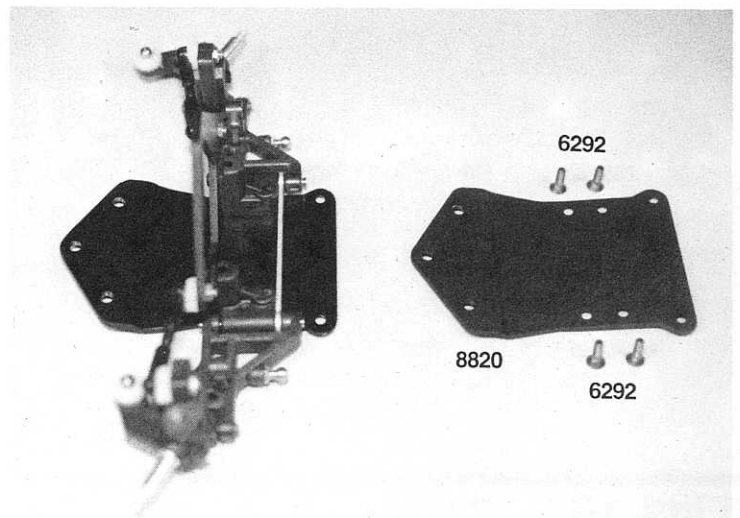

Fig. 21

SERVO SAVER ASSEMBLY

□ **Figs. 22 & 23** 1) From the kit box remove your #6301 black anodized aluminum chassis. 2) Remove the #6931 8-32 x 1/4" steel flat head machine screw from bag #8-1. 3) Place the nose plate and front end assembly over the front of the chassis as shown. There are three holes in the nose plate that need to line up with the three countersunk holes in the front of the chassis. 4) Take the 8-32 x 1/4" machine screw and thread it into the center hole from the bottom of the chassis. Just lightly secure the nose plate so that there is not a lot of space between the top of the chassis and the bottom of the nose plate. We will tighten this screw later.

5) We are going to leave bag #8-1 for a moment and open bag #8-2. Remove the two #7306 special servo saver mounting screws. The long screw is for the servo saver side of the steering and the short screw is for the bellcrank side of the steering. On the Dual Sport the long screw will be on the left (or driver's) side and the short screw will be on the right (or passenger) side. 6) Install these screws from the bottom of the chassis. 7) After both screws have been installed, go ahead and tighten them and the #6931 screw.

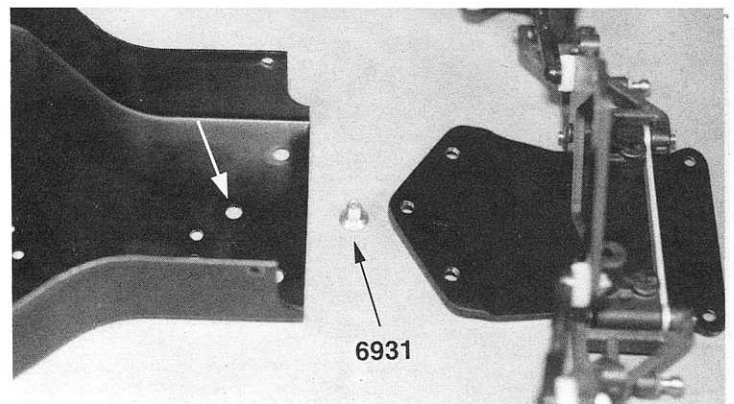
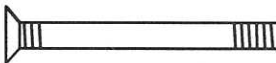
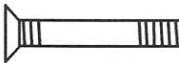

Fig. 22

 #7306
1 3/8
special

 #7306
7/8
special

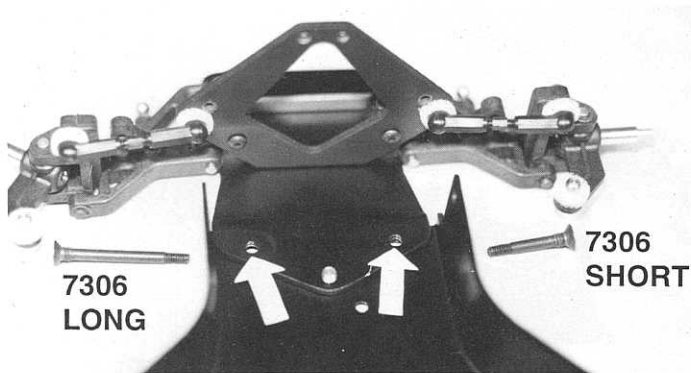

Fig. 23

#6931
8-32 x 1/4
steel

□ **Fig. 24** Inside the same bag you will find the #7531 plastic servo saver parts tree and the #9156 aluminum servo saver tube. The names of the parts on the parts tree are: (1) left upper servo saver arm, (2) lower servo saver bushing, (3) upper servo saver bushing, (4) left lower servo saver arm, (5) right side bellcrank. Remove the two servo saver bushings and install them into the servo saver tube. The upper bushing goes into the threaded end of the tube and the lower bushing goes into the hex end of the tube.

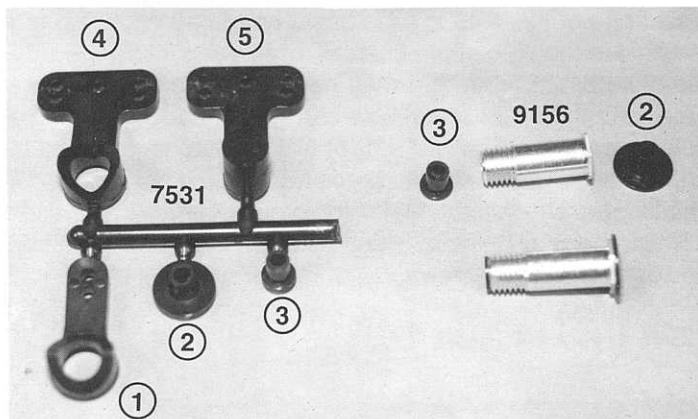

Fig. 24

□ **Fig. 25 & 26** 1) Take out the #9157 servo saver spring and the #9157 aluminum spring adjusting nut from bag #8-2. 2) Now remove the lower left servo saver arm from the parts tree. 3) Before we install the lower servo saver arm over the aluminum tube, look at the bottom of the arm. You will find a recessed hex shaped area that will match up with the hex portion at the bottom of the aluminum tube. Slide the lower servo saver arm over the aluminum tube and push it down until the tube hex fits into the hex shaped recess. 4) Next we need to remove the upper servo saver arm. Install it over the tube with the "V" shaped portion facing down into the "V" groove of the lower arm. Make sure the upper arm is facing to the right (with the lower arm facing away from you) as shown in the photo. **Racer's Tip: Team drivers coat the V-groove portion of the servo saver with a small amount of the #6588 black grease**

to improve the servo saver performance.

5) If you look at the top of the upper left servo saver arm (after it is installed onto the aluminum tube) you will see there is a recessed area. Slide the spring over the aluminum tube and into the recessed area. 6) Look closely at the spring adjusting nut. You will see that one side of this nut also has a recessed area. Slide the nut over the tube, recessed side first, and thread it onto the tube. 7) Tighten the nut until 1/32" of the tube threads is exposed above the adjusting nut. **Racer's Tip: You can adjust the servo saver tension by tightening or loosening the aluminum adjusting nut. This changes the tension on the servo saver spring. The more you tighten the servo saver spring, the more load you transfer to the servo gears. The adjusting nut should only be below the initial setting under limited racing conditions on an extremely high bite track.**

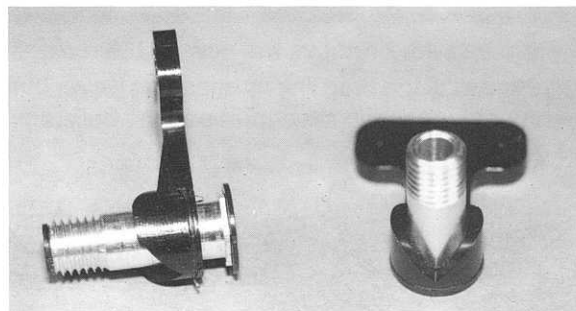

Fig. 25

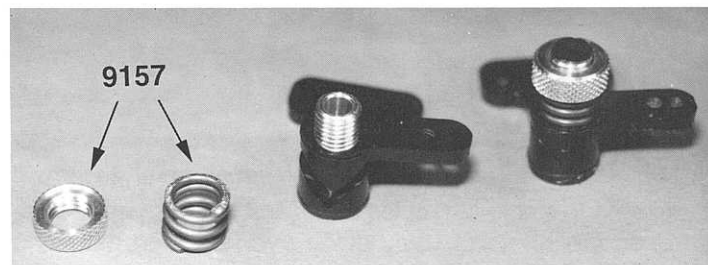

Fig. 26

□ **Fig. 27** Now we need to go back to bag #8-14 and remove five #6270 short ball ends and five #6272 foam ball end dust covers. Layout the left servo saver arm assembly and the right bellcrank as shown in the photo. Now we need to thread the five ball ends into the servo saver and bellcrank. After all of the ball ends are installed you can then push the #6272 foam dust covers over the ball ends. **Note: You do not need to install nuts on the bottom of these five ball ends.**

#6270
4-40

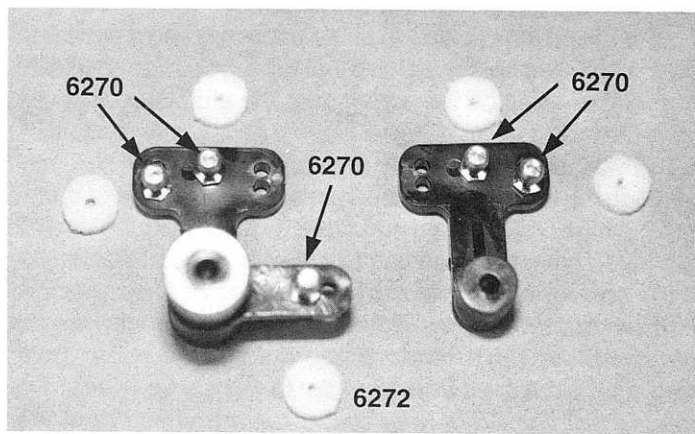

Fig. 27

□ **Fig. 28** From bag #8-2 remove the new #6265 molded drag link. We want to install the drag link by snapping it over the two center balls on both the servo saver arm and the bellcrank as shown in the photo.

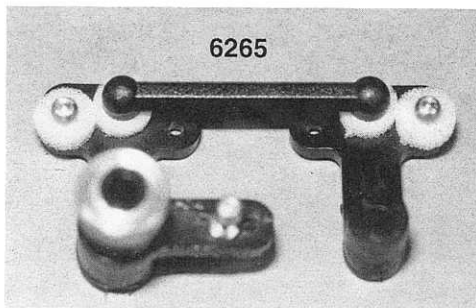



Fig. 28

□ **Fig. 29** 1) In order to install the servo saver assembly you will need to start with the left side. Turn the assembly to the right. Slide the arm assembly down over the long mounting screw. When the arm is at the bottom of the screw, rotate it to the left so that you can install the right bellcrank assembly over the short screw. The areas that you have to work around are the front shock strut mounting screw and the left upper servo saver arm. Move the bellcrank around to clear these as needed.

2) Now remove the two #6222 4-40/5-50 black self threading nylon locknuts (from bag #8-2) and thread them onto the #7306 servo saver mounting screws. 3) Tighten the nuts to take up any vertical free play or movement of the servo saver or bellcrank but **not so tight that it causes binding**. We want the servo saver arm and bellcrank to be able to swing freely to both the left and right. **Note: When you thread the #6222 nylon locknut over the left servo saver, the bottom of the nut will be going down over an unthreaded portion of the screw. Do not worry; this will not affect the holding power of the nut.**

 #6222
 4-40/5-40
 nylon locknut

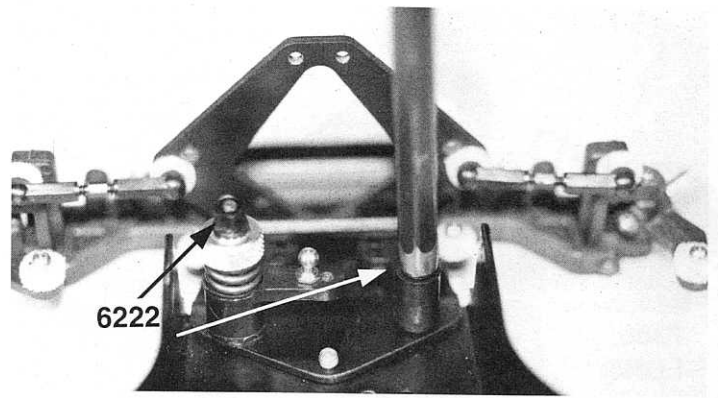



Fig. 29

□ **Figs. 30 & 31** 1) Now from bag #8-1 take out the two #8822 aluminum nose brace tubes, two #6285 4-40 x 1/4" socket head cap screws, and two #6919 4-40 x 5/16" button head socket screws. 2) Now look at the two #8822 nose brace tubes. You will see that on one end there is a hole drilled through the side that is threaded. This will be the back end of the tube. If you look at the front end of the tube you will see that the inside hole is threaded. 3) Install the button head screw into the front of the shock strut. Use the right side hole of the strut (next to the ball end) so that the screw threads come out the back of the shock strut. 4) Now line up the threaded end of the nose brace tube and thread the tube onto the button head screw. Leave a little play so we can line up the other end easily. 5) Now install one of the 4-40 x 1/4" socket head cap screws through the hole in the side of the chassis and thread it into the side of the nose brace tube. You may have to rotate the nose brace tube so that the screw and hole can line up correctly. Again, do not tighten this screw just yet. 6) Now repeat the above steps and install the second nose brace tube on the other side of the chassis and shock strut. Make sure you still leave these screws a little loose until both sides are installed, then you can go back and tighten all four screws.

 #6285
 4-40 x 1/4" steel

 #6919
 4-40 x 5/16"

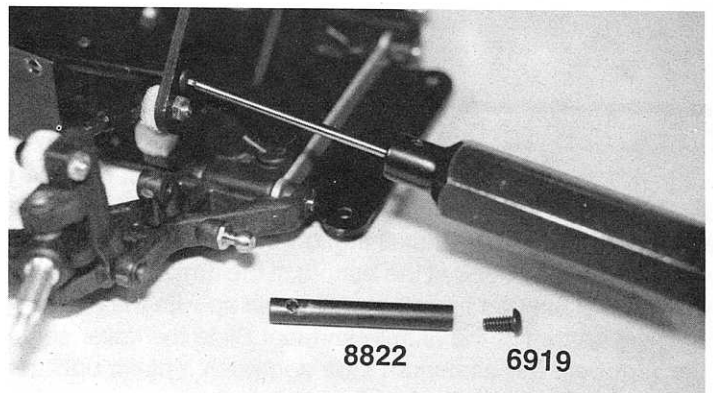

Fig. 30

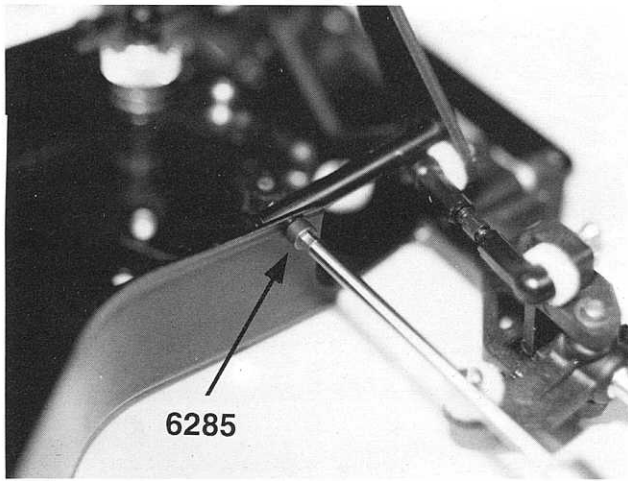

Fig. 31

□ **Figs. 32 & 33** 1) Now remove the #6260 turnbuckles from bag #8-2 (the last two items in the bag). 2) You will also need to go back to bag #8-14 and remove four more of the #6274 plastic ball end cups. These turnbuckles will become the two steering tie-rods. We are again going to thread the ball cups onto the two turnbuckles. 3) The turnbuckles have both left and right handed threads on them. All adjustments are measured from the center of one ball cup hole to the center of the other ball cup hole, as shown in the drawing below. Go back to fig. 18 for procedures on putting ball cups onto the turnbuckles.

Thread on the ball end cups equally until you achieve a length of $1 \frac{11}{16}$ " (1.69" or 42.9mm). 4) Snap the turnbuckles onto the steering ball ends using your needlenose pliers. On these turnbuckles both ball cups will be facing the same direction. To make it easier to install the inside ball cup, rotate the servo saver so that the inside ball is exposed as much as possible. Reverse the servo saver direction when you have to install the other turnbuckle on the other side of the car.

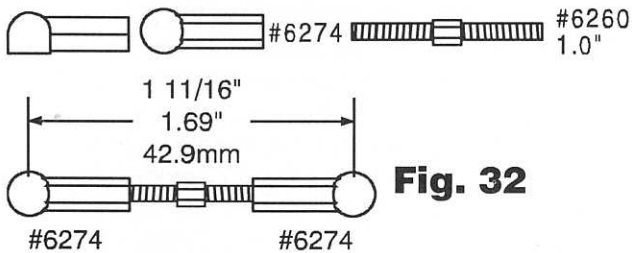

Fig. 32

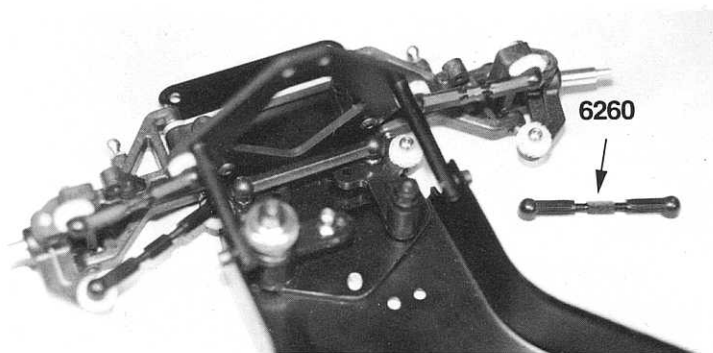

Fig. 33

FRONT ANTI ROLL/SWAY BAR ASSEMBLY

□ **Fig. 34** Now open bag #8-3 and remove the two #6270 short ball ends. If you look at the front of the car you will see a hole on the leading edge of each of the front arms. Thread one of the short ball ends into each of the two holes. Because of the shape of the arm you may not be able to fully install the ball ends with a nut driver or socket. Use your #8416 shock/turn-buckle wrench or needlenose pliers to finish the job.

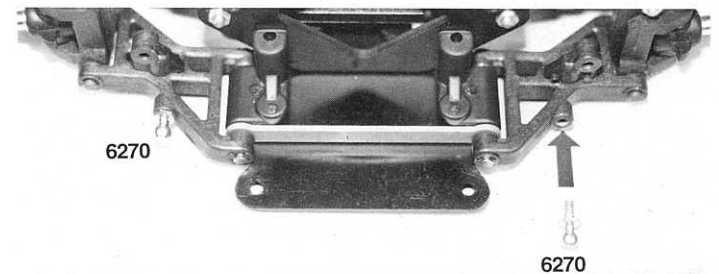

Fig. 34

□ **Fig. 35** Go back to bag #8-3 and remove the parts tree containing the #8828 molded roll bar ball cups, and two #8828 4-40 x 5/16" socket set screws. If you look at the ball cups you will find two with an open cup and two that have a closed cup. Thread one open cup and one closed cup onto each of the 5/16" set screws. Do your best to thread them on equally and then make sure they go on until they bottom out against each other. This will now become the adjustable pivot link. Because of their small size you can use your .050" Allen wrench to thread one cup onto the set screw. After one is installed thread on the other one until it bottoms out.

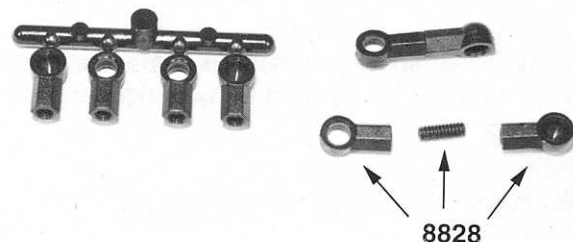



Fig. 35

□ **Fig. 36** We can now take out the #8826 roll bar wire and the two #6920 4-40 x 3/16" button head socket screws. Look at the front side of the front bulkhead. At the top of each bulkhead section, next to the shock strut, you will find a small recess and a hole. Lay the wire in the two recesses with the ends going towards the front of the car. Now use the two #6920 screws to hold the wire in place by threading them into the two holes at

the top of the bulkhead. Carefully tighten them after both have been installed.

 #6920
4-40 x 3/16

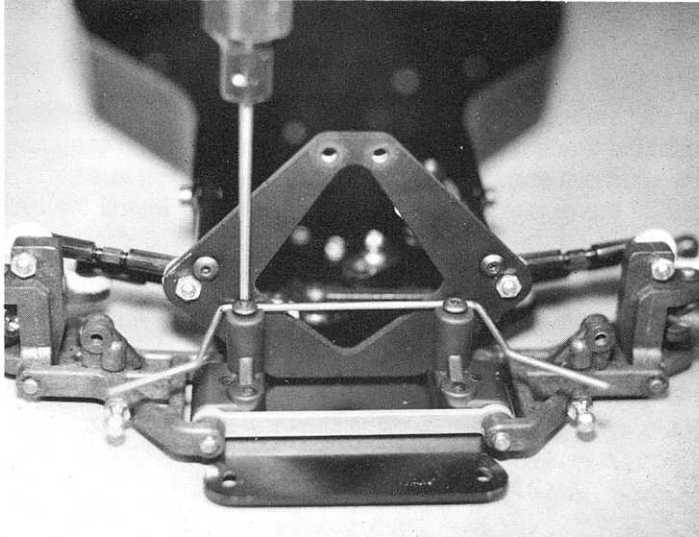



Fig. 36

Fig. 37 & 38 1) (Fig. 37.) Now we can remove the two #8830 aluminum roll bar pivots and two #6951 4-40 x 1/8" socket set screws. **2)** There is a hole through the center of the pivots. Slide the roll bar wire through the hole (collar side first) until the wire just comes out the front of the pivot. **3)** Now take the set screw and thread it into the collar. Just lightly snug it down for now. We will make some adjustments in a moment. **4)** Install the other pivot ball on the opposite end of the roll bar.

5) (Fig. 38.) Now go back and pick up the #8828 adjustable pivot links (we assembled them in fig. 35) and snap the closed ball end cup onto the ball end of the front suspension arm, and **6)** the open ball end onto the roll bar pivot. **7)** After both adjustable links have been installed we will need to set the roll bar pivot position. Looking at the front end assembly from the front of the car, adjust the pivot balls so that both of the adjustable links are close to vertical. We want to make sure that the pivot balls are not binding but still remain close to vertical. **8)** Once they are lined up correctly and pivoting freely, tighten the set screws. **9)** Make sure that the spacing on both roll bar pivots is the same. If the spacing is not the same, the car's handling characteristics will be different for both right and left turns.

 #6951
set screw

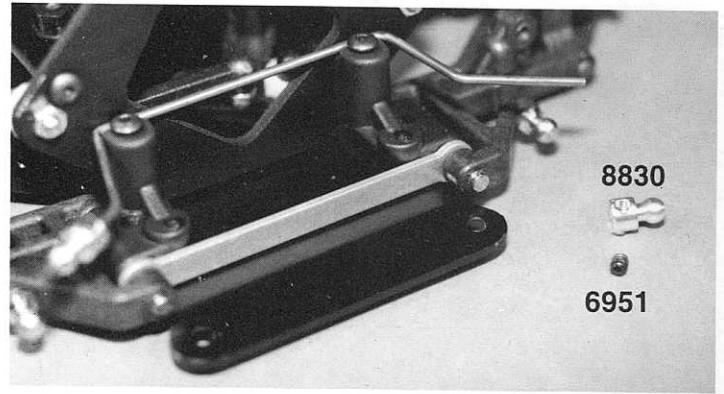

Fig. 37

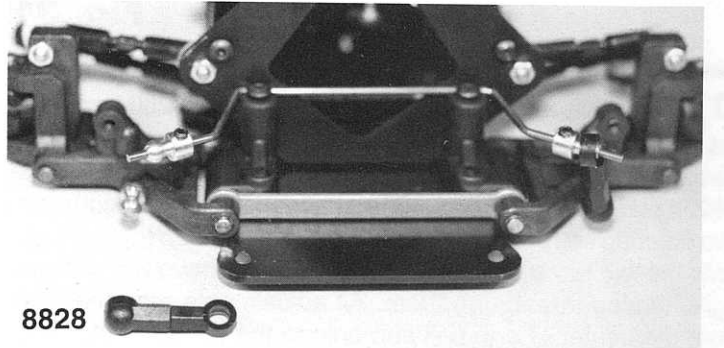

Fig. 38

FRONT BUMPER ASSEMBLY

Fig. 39 1) Open bag #8-4, the front bumper bag, and remove the #8816 front bumper, two #6922 4-40 x 1/2" flat head socket screws, and two #6222 4-40/5-40 black nylon self threading locknuts. **2)** Near the center of the bumper there are two mounting holes. They are on the back edge. The "AE" indicates the top of the bumper. Place the back edge of the bumper over the front aluminum kick up then line up the holes in the bumper with the holes in the kick up. In the bottom of the bumper there is a ridge designed to fit against the front of the nose plate. Install the two #6922 screws through the bottom of the kick up and then the bumper. **3)** Now thread the #6222 nylon nuts on to the threads and tighten both nuts to secure the bumper. After the bumper is installed you can set your chassis aside for a few moments.

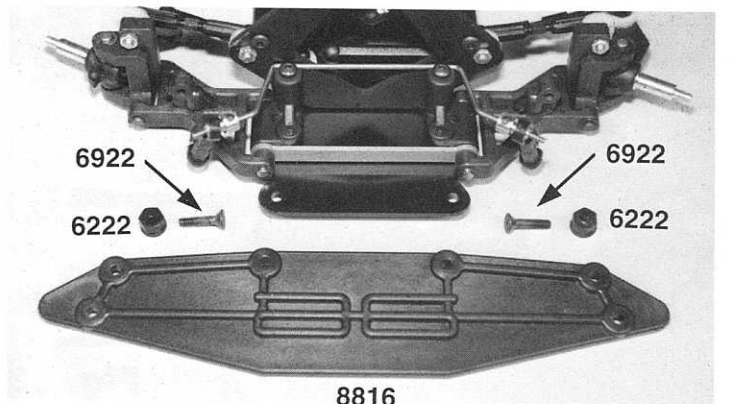

Fig. 39

#6922
4-40 x 1/2



#6222
4-40/5-40
nylon locknut

2.25:1 STEALTH TRANSMISSION ASSEMBLY

Your new Dual Sport includes the original race proven Stealth transmission. It has been used to win many National and World Championship Titles and is the design base for the GT, T2, and B2 versions of the Stealth tranny. This low maintenance, low drag transmission gives you excellent adjustability for almost any track condition. You will find that when assembled correctly and properly maintained, your vehicle's performance and reliability will be about the best around. This all depends, of course, on how well you assemble and maintain the transmission. So take your time during assembly and frequently clean and re-lube your parts. **Note:** *All of the molded parts in this transmission are made of engineered materials. This means you have to use lubrication only where we indicate in the assembly manual. The life of these parts are greatly affected by frequency of maintenance. This does not mean you have to replace parts each time, just that frequent cleaning and lubing will increase part life and performance.*

Please note that during the assembly of the transmission we will be using the same instructions showing assembly of both the bushing and ball bearing kits. The only parts that will be different will be either the bushings or ball bearings, so the only bag that will be different will be bag B. If you are uncertain which kit you have, the description on the box end label underneath the retail price and model number will indicate if you have ball bearings.

Fig. 40 1) Open the Stealth main bag. Inside you will find several smaller bags. You will find bags marked A, B, C, D, E, & F. You will also find a couple that have no markings and two tubes of lubricants. Remove the tube of #6591 Stealth diff lube (this will be an almost clear lube) from the main bag. 2) Now open bag A and remove the #6580 diff gear, and the bag containing the twelve #6581 3/32" carbide diff balls. There are two bags with balls in this bag, we want the bag with the larger balls. These carbide balls are the best available. They will outlast the drive rings at least ten times (if the diff is kept clean and lubed).

WARNING!! NEVER replace your 3/32" diff balls with any other balls except our #6581 carbide diff balls. The tolerances we use are tighter than any other company that we know of. Due to these tight tolerances and careful packaging of matched balls, when replacing lost or worn 3/32" diff balls, you MUST replace ALL 3/32" balls at the same time with new balls from the same package. This means you cannot even mix balls from two different #6581 packages. Not observing this warning will reduce your diff consistency and performance and could cause premature part failure.

3) Look at the center hole of the #6580 diff gear. If there is any flashing on the inside hole (as indicated in the photo) you

must remove it, or the diff will not work or go together correctly. Use your X-acto® knife to carefully trim any flash from the center hole. We suggest using the tip of the blade since it will turn easier and follow the shape of the gear with less chance of damage to the gear. It is important to remove only the flashing and not any of the gear material.

4) There are twelve holes in the diff gear. Fill each hole with #6591 silicone diff lube. **WARNING!! DO NOT substitute any other type of diff lube on the balls. It took us countless hours of intense testing to find the correct silicone diff lube to make the diff work correctly. Do yourself a favor: use what comes in your kit. While the #6591 is called silicone diff lube, it actually is a silicone compound. It is not used to make the diff slip, like most people would think, it is used to control how fast the diff locks up. Lube has just become a standard description for all greases and silicone compounds.** 5) Now gently push the twelve 3/32" balls into the twelve holes around the gear. 6) After all of the balls are installed wipe the excess lube back into the ball holes with your finger. You will see your diff gear with balls installed in the third step of the photo. 7) Clean the diff lube from your hands. We do not want to take a chance of this lube getting mixed into the #6588 black grease that we will use in a few steps.

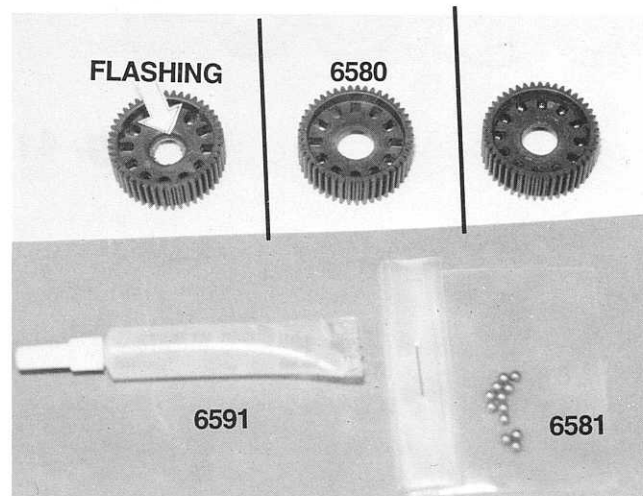





Fig. 40

Fig. 41 & 42 Open bag B of the Stealth main bag. (This will be the only transmission bag that will be different between the two kit versions.) If you have a ball bearing kit, use the parts and part numbers on the left side of fig. 41. If you have a bushing kit, use the parts and part numbers on the right side. All kits (bushing and ball bearing) will use a #6596 bushing for the torque clutch. If you have a ball bearing kit you will have eight bearings and one bushing. If you have a bushing kit you will have nine bushings. **Note:** *All of the bushings used in this kit are pre-oiled through a special manufacturing process, so no oil is needed on the bushings during assembly.*

4) Remove one of the #6589 5/32" x 5/16" unflanged ball bearings or one of the #6597 5/32" x 5/16" unflanged bronze bushings. **WARNING!! On bushing kits both the #6596 and #6597 bushings have the same outside diameter, only the inside diameter is different. Do not use the larger inside diameter bushing in this step. If you do, the torque clutch will not go together later and you will have to take the trans-**

mission and differential apart again to locate the #6596 bushing. 5) Place the #6589 bearing or #6597 bushing into the center hole of the diff gear as shown.

-  #6589
5/32 x 5/16
unflanged bearing
-  #6597
5/32 x 5/16
unflanged bushing
-  #6596
3/16 x 5/16
unflanged bushing

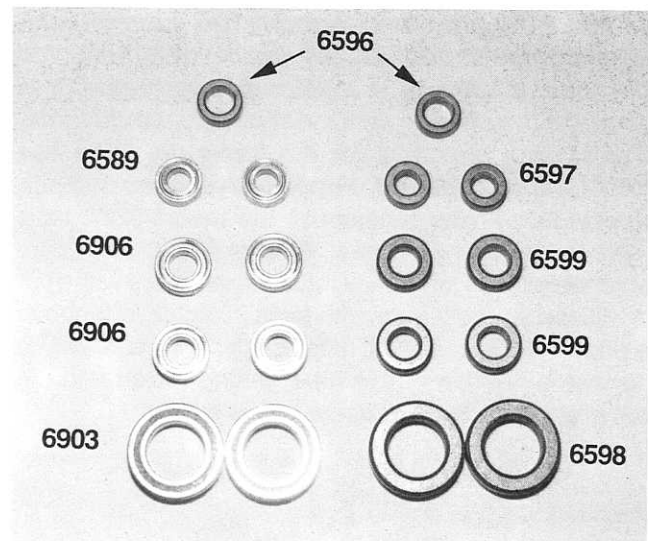

Fig. 41

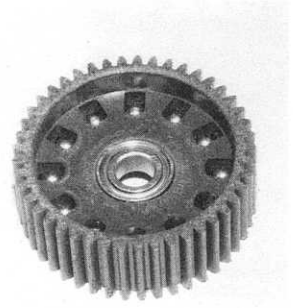

Fig. 42

□ Figs. 43, 44, 45 & 46 1) Back in bag A you will find a molded parts tree containing the #6575 T-nut and diff thrust bolt cover. 2) Trim the two parts from the tree as shown in fig. 43. **WARNING!! Make sure you do not cut the "ears" off the T-nut or thrust bolt cover. The ears are needed to prevent the parts from spinning freely in the outdrives.** For now set the diff thrust bolt cover aside; we will use it near the end of the transmission assembly.

3) Now remove the #6582 diff thrust spring and the #6578 left diff outdrive hub (the one with the small nipple on it) from the same bag A. **WARNING!! Please make sure you do not get the #6582 diff thrust spring mixed up with the #6587 torque control spring (from bag E) we will be installing later. The torque control spring has a slightly larger outside diameter and will jam inside the diff outdrive hub if forced in.** Now check to make sure that there are no burrs or residue on the inside or outside, of the diff outdrive hub, which could damage parts or reduce the performance of the diff. Slide the diff spring into the left diff outdrive hub. It should slide in or

go in with very light pressure until it reaches the bottom of the outdrive. Next, align the T-nut with the slots in the outdrive and push it. Make sure the steel insert side goes in first. This will place the ears on the outside away from the spring. Slide the T-nut all the way down against the spring.

(Fig. 45.) The ears on the T-nut should be approximately 3/32" or a little less than .100" from the bottom of the slot. Take your X-acto© knife and trim off any of the plastic T-nut that extends outside both sides of the slot in the outdrive hub. The diff outdrive hub will not slide through the ball bearing later if we do not take care of this now. **WARNING!! Be careful here so that you do not cut yourself, since you will be cutting towards your thumb.**

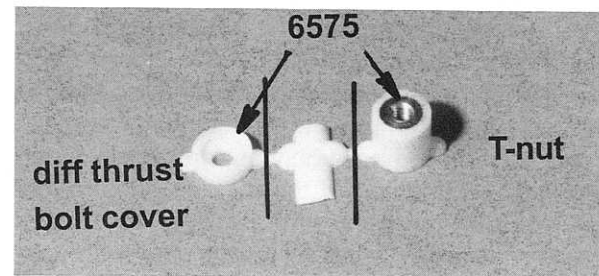

Fig. 43

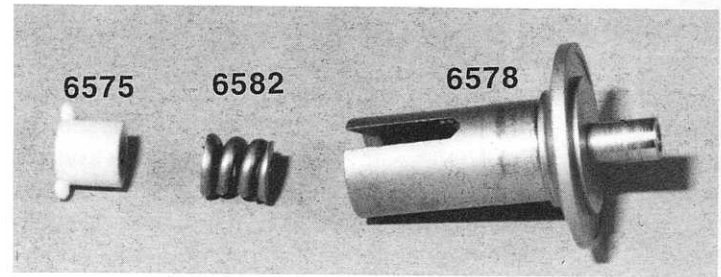

Fig. 44

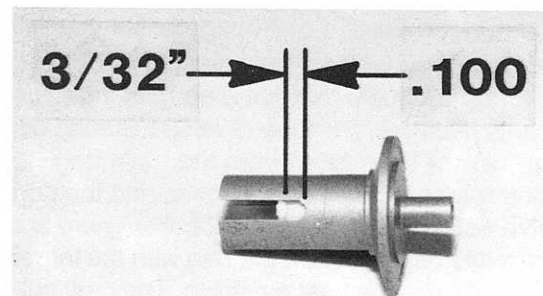

Fig. 45

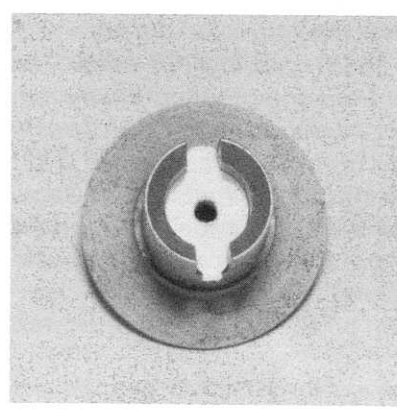

Fig. 46

❑ **Fig. 47** 1) Still using bag A remove the small bag containing the six #6574 5/64" diff thrust balls, Remove another small bag that contains the two #6573 diff thrust washers (special hardened steel washers) and the #6575 diff thrust bolt which we also need to remove. **WARNING!! Again follow the same warning we explained in fig. 40 about only using the balls that came with the kit. These are special tight tolerance balls that are not available from any other company that we know of. Remember, the tolerance is so tight that you cannot even mix balls from two different bags of Associated #6574 diff thrust balls. You must replace all six at the same time or you will reduce the performance and durability of the diff assembly.**

2) Now slide one of the #6573 diff thrust washers onto the #6575 diff thrust bolt. **Racer's Tip: Carefully look at the center hole of the first thrust washer; you will see that each side is beveled. One side is beveled more than the other; this side is installed towards the head of the thrust bolt. This will help to insure that the thrust assembly will work as smoothly as possible.** 3) Go back to the Stealth main bag and remove the tube of #6588 black grease. 4) Open the tube and place a small amount on the washer. Use just enough grease to hold the six balls you will place on the washer. **WARNING!! DO NOT use the #6591 Stealth silicone diff lube on the #6574 diff thrust balls.** 5) Now carefully place six #6574 balls in the grease around the washer. 6) Slide on the second washer until it contacts the balls. **WARNING!! Make sure that you have exactly six thrust balls installed between the washers. More than six will cause the diff to back off and less than six can cause the thrust washers to crack.**

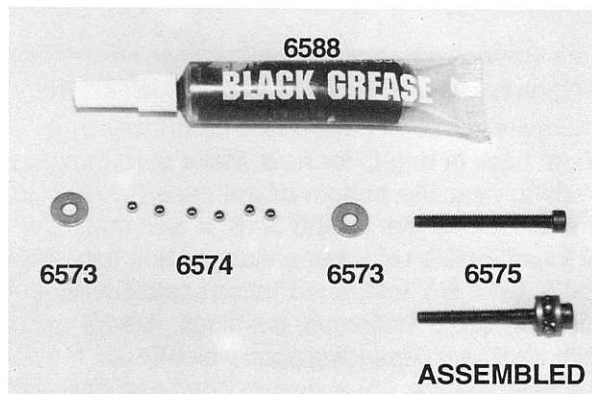
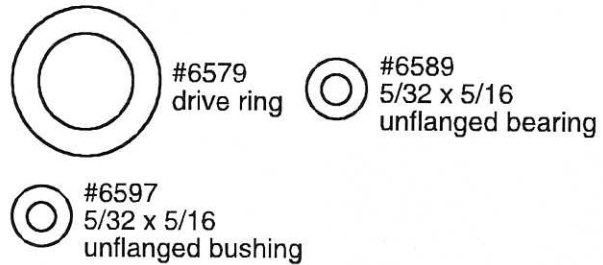

Fig. 47

⊙ #6573 □ #6575

❑ **Fig. 48** Remove the #6577 right diff outdrive hub and one of the #6579 diff drive rings from bag A. Go back to bag B and remove either the second #6589 5/32" x 5/16" unflanged ball bearing or #6597 5/32" x 5/16" unflanged bushing (depending upon which kit you purchased). Now check to make sure that there are no burrs or residue on the inside or outside of the diff outdrive hub, which could damage parts or reduce the performance of the diff. Install the #6589 ball bearing or #6597 bushing into the cavity in the center of the #6577 right diff hub. It should push in with your finger. **Never drive or force the bearing or bushing into the hub cavity.** Now place the #6579

drive ring onto the outdrive hub as shown. **Racer's Tip: Our Team drivers always check the diff drive rings for the side that is more rounded on the outer edge. They place this side against the hub as it gives you a more consistent diff action. If you are on a budget you can still use both sides of the drive rings to reduce your maintenance costs. DO NOT try to pin the drive rings to the diff hubs as is done on other designs. Our hub and drive rings are designed to lock the drive ring without pinning. Please leave the diff AS IS.**



6599 BUSHING KIT

6589 BEARING KIT



6579

①



6577

②

BUSHING OR BEARING

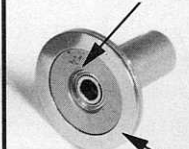

6579

Fig. 48

❑ **Fig. 49** Go back to your #6950 tool bag and remove the 5/64" Allen wrench. Slide the long leg of the Allen wrench into the head of the #6575 diff thrust bolt. We will be inserting the bolt, washers, and thrust balls into the center of the #6577 right diff outdrive. **Note: An Associated #6959 5/64" Allen driver would work well here.**

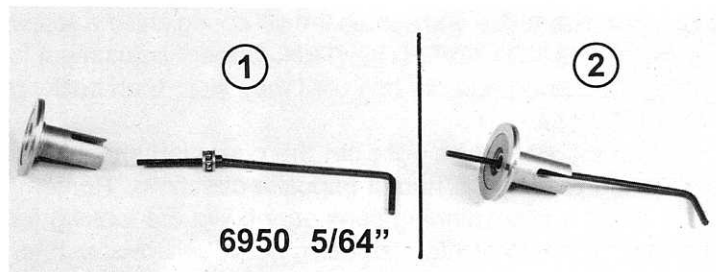

Fig. 49

❑ **Fig. 50** With the Allen wrench still in the head of the diff bolt, turn the right diff outdrive hub upright so that the wrench is on the bottom. Make sure that the #6579 diff drive ring is still on the hub and centered. Now pick up the #6580 diff gear (with the 3/32" diff balls and ball bearing or bushing installed) and slip it over the diff thrust bolt. We want to center it onto the diff drive ring on the right diff outdrive hub.

Go back to bag A and remove the second #6579 diff drive ring. Install this ring over the diff thrust bolt and down over the balls on the top side of the gear as shown in the photo. If you are doing the racer setup, the rounded side will be up. **WARNING!! If you remove the diff gear before you completely assemble the diff halves, always double check to see that you do not have both drive rings on the same side. This can happen easily because one drive ring may stick to the diff gear and the other may stick to one hub. It is easy to turn the diff gear around without realizing it. This situation would place both drive rings on the same side and the diff will not work correctly.**

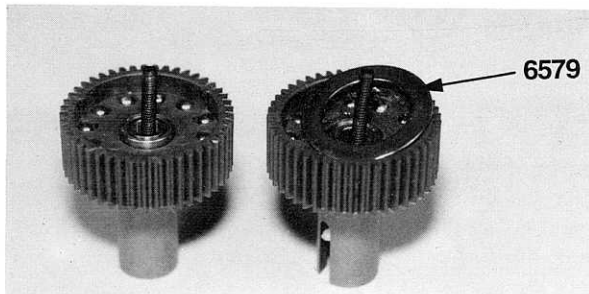

Fig. 50

problem). Bottoming out the spring and bolt is very important. The tension of the spring can only be consistent if you start from the same point. A fully collapsed spring is your starting point. This way, when you back off the bolt 1/8 of a turn you will always have the same spring tension, so your diff will be consistent. We again remind you that this diff is not designed to slip. We use the torque clutch to control any slippage the car needs. This is why the wrong diff lube or even silicone compound can allow the diff to slip, which would reduce transmission performance and increase parts wear.

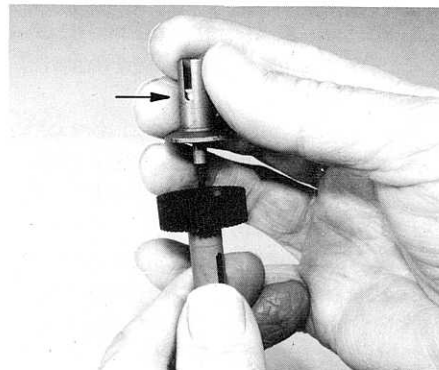

Fig. 51

Fig. 51 & 52 Now we are going to install the #6578 left diff outdrive assembly over the #6575 diff thrust bolt. **1)** Slide the thrust bolt into the hole of the nipple on the left outdrive, then lightly push the nipple through the center of the diff gear bearing or bushing. Make sure the outdrive hub centers on the top diff drive ring when it fits into the center of the diff gear. **Note:** When picking up the left outdrive hub, place your finger over the slotted end of the hub to prevent any chance of the T-nut and diff spring from falling out during this assembly. Make sure you securely hold the Allen wrench in the head of the diff thrust bolt. This will prevent the bolt, washers, and thrust balls from sliding out during assembly and possibly losing any of the diff thrust balls.

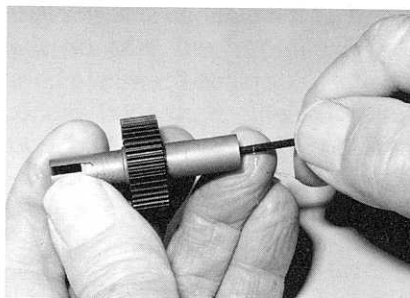
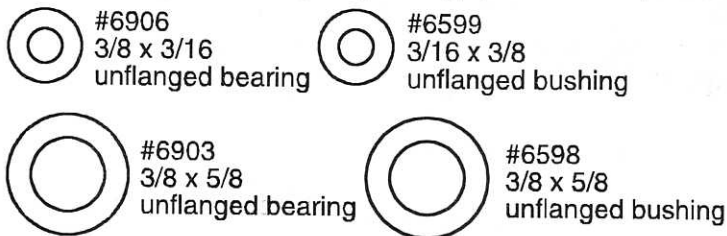

Fig. 52

2) Tighten the bolt using the Allen wrench, making sure that the hubs and drive rings stay centered. **3)** Once you have lightly snugged the two halves together you can turn the diff assembly on its side to make the final adjustment easier. Fig. 52. Hold the left outdrive and tighten the diff spring and the screw until it stops. **DO NOT OVERTIGHTEN.** Correct adjustment is tightening the spring and diff bolt until they stop, then backing the bolt off 1/8 of a turn.

Fig. 53 Open bag C and remove the #6565 left and right case halves. There are five other parts on the parts tree so make sure you put them back in bag C for now. Make sure that you remove any flashing near the bottom of the case halves. Go back to bag B and remove four #6906 3/16" x 3/8" unflanged ball bearings or four #6599 3/16" x 3/8" unflanged bushing. Also remove two #6903 3/8" x 5/8" unflanged Teflon sealed ball bearings or two #6598 3/8" x 5/8" unflanged bushings. (Bag B is the only tranny bag that will vary depending upon which kit you have.) In the photo we have installed bushings in one case half and ball bearings in the other case half. Both halves will receive the same bushings or bearings depending upon which kit you have.

The diff should be tight but the operation should feel smooth when turning the hub in opposite directions. Remember, this is not a free spinning component. We are looking for the ball rolling motion to feel smooth, not rough. **Note:** After you have run the car once you will need to recheck the diff adjustment. The first run will make sure all the parts seat correctly. After you have rechecked the diff it should only be necessary to check the diff adjustment occasionally.



ADJUSTING THE DIFF. As you are tightening the diff bolt, you will notice the ears on the T-nut moving closer to the bottom of the slots in the left diff outdrive hub. This causes the diff spring (behind the T-nut) to compress. The spring and diff bolt should stop about the same time as the T-nut ears reach the bottom of the slot (if it is off by only a small amount there is no

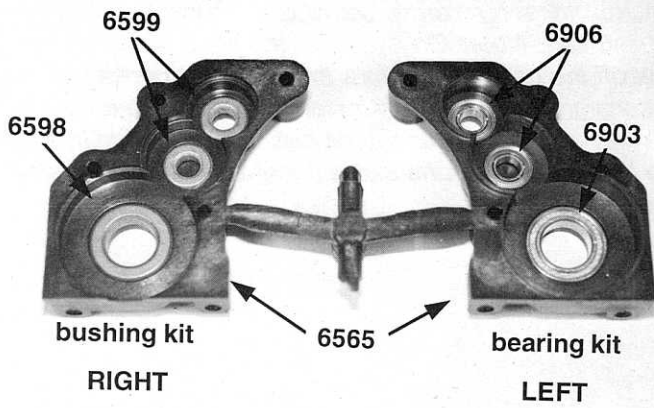

Fig. 53

□ **Figs. 54 & 55** 1) Open bag D and remove the #6571 drive gear/shaft assembly. 2) Carefully deburr the roll pin hole in the drive gear shaft. We are trying to make sure the hole is not blocked and that there are no raised edges around the hole that will prevent the bearing or bushing from sliding onto the shaft. Be sure to deburr both sides of the hole. 3) Now insert the #6571 drive gear/shaft through the upper bearing in the right case half. The shaft will be on the outside of the case and the gear on the inside against the ball bearing.

4) Now open bag E and remove the #6572 roll pin. Using your needlenose pliers squeeze the roll pin into the hole of the drive gear/shaft. Do your best to center the roll pin. **Racer's Tip: you can use your needlenose pliers to gently close the split on one end of the roll pin. This slightly smaller end will then be easier to get started into the hole.**

≡ #6572
roll pin

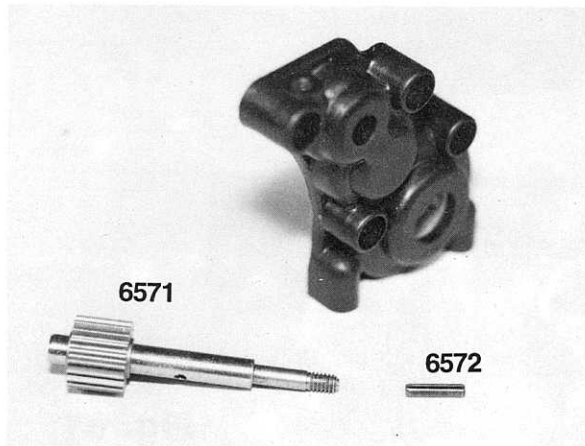

Fig. 54

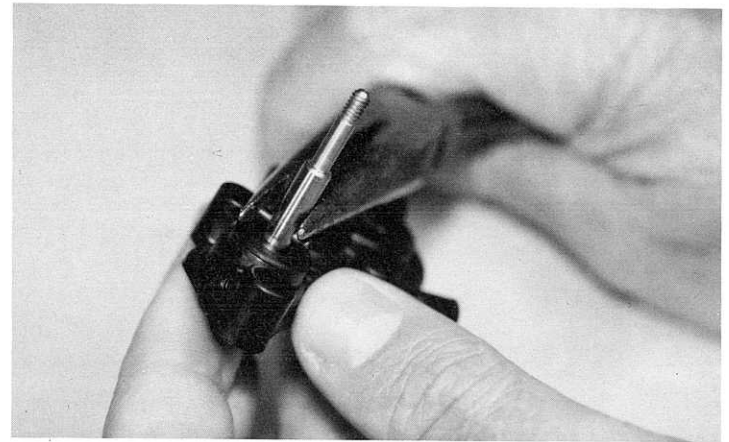

Fig. 55

□ **Figs. 56 & 57** We now need to install the diff assembly into the right case half. We need to make sure that the diff bolt head goes through the right case half. We want to end up with both adjustment points on the same side (the torque clutch and diff bolt). **WARNING!! If you install the diff bolt head so that it is on the driver's side of the transmission, you may have a problem with the diff adjustment backing off and the diff then slipping.**

Go back to bag D and remove the #6570 idler gear and shaft. Install the idler gear into the center bearing on the right case half. You may have to turn the gear so that it will mesh with the other two gears in the case. It does not matter which way the idler gear goes in, it will work correctly either way.

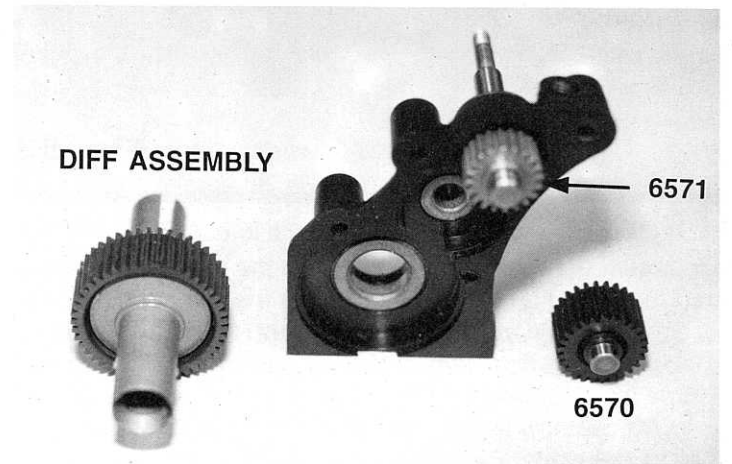

Fig. 56

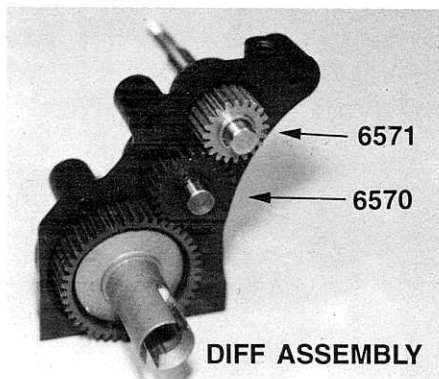

Fig. 57

□ **Fig. 58** Open bag F and remove the four #6928 4-40 x 1" socket head cap screws. Thread them into the bolt hole locations on the left hand case. Take the left hand case and install it over the gears and differential, making sure that each gear fits into the appropriate bearing or bushing. There is a locating ridge on the inside of the case to help line up the case halves. Screw the bolts in until they extend out the right side of the case 1/8".

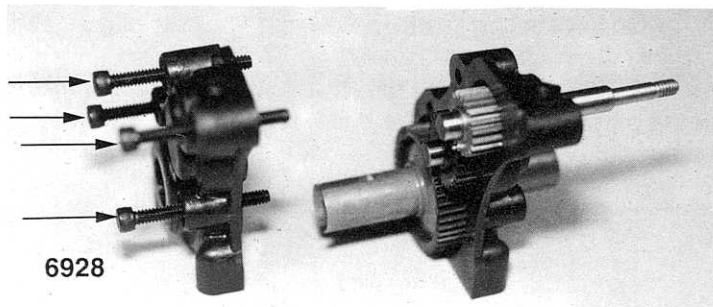
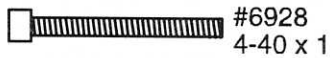

Fig. 58

□ **Figs. 59, 60 & 61** 1) Back in bag C you will find the four #6569 motor plate spacers and the case dust end cap on the remaining parts tree. 2) Remove the five parts from the tree. Set the end cap aside for a moment. 3) In bag F you will find the #6566 felt dust seal. 4) You will need to carefully remove the three felt cutouts where the motor plate spacers will go (fig. 59). 5) We can now install three of the motor plate spacers into the felt seal like this: The felt seal will only go on one way, so line it up over the holes in the case, before you start, so you will know how it is installed. Lay the felt seal down with the case side up. Install the three #6569 spacers so that the small end is pointing up. The small ends of the spacers will fit into the case holes on the right side of the case. The fourth spacer will fit into the bottom front hole which is not covered by the felt dust seal. 6) Now install the felt seal and three spacers over the drive shaft and onto the case as shown (fig. 60). The spacers will also be going over the threaded ends of the four #6928 case screws. 7) Install the fourth motor plate spacer in the front hole.

8) Orient the tranny as in fig. 61. If you look at the upper part of the case you will see a hole in the left side at the drive gear/shaft location. You will need to press the #6569 case dust

end cap into the hole in the case at the end of the drive gear/shaft. You will see an arrow pointing to the location for the case dust end cap. **Note:** On occasion the case dust end cap will break off the parts tree before the parts are packaged. When this occurs we will normally install the end cap into one of the case halves so that it cannot get lost. If it is installed in the right case half push it out and install it in the left case half where it belongs.

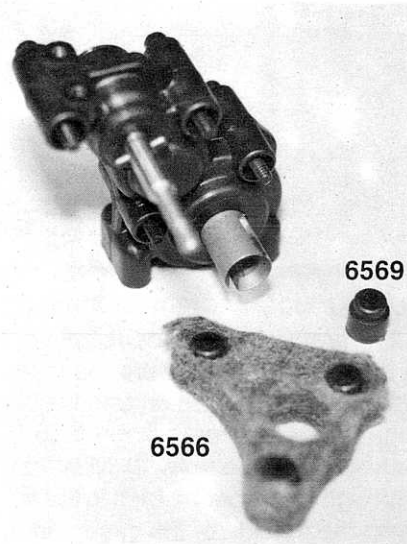

Fig. 59

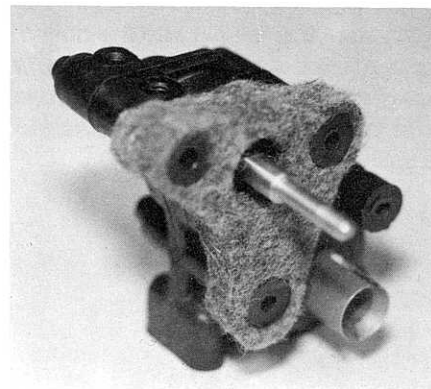

Fig. 60

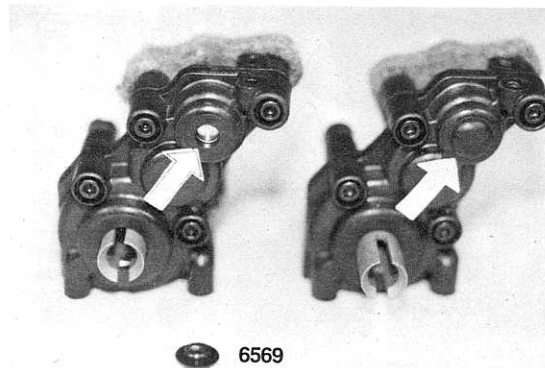

Fig. 61

□ **Fig. 62** In the Stealth main bag you will find the #6604 black anodized motor mounting plate. Place the motor plate over the drive gear/shaft. There are four holes around the motor plate shaft opening. You will need to line up the four threaded

holes in the motor plate with the four screws that are coming through the case. **Tighten all four screws after the screws have been started into the holes.** These screws only have to be snugged down evenly. Overtightening these screws can give you transmission problems in the future.



Fig. 62

Fig. 63 We can now start to assemble the Associated Torque Control assembly. Go to bag E and remove the #6583 inner torque control hub. Fig. 63 shows you both a front and back view of the inner hub. We now need to slide the inner hub over the drive gear/shaft. We want to install the back side first (the side with the slot) so that we can line up the slot in the hub with the #6572 roll pin going through the shaft. We want the slot, in the hub, to go down over the roll pin so that it will be locked with the shaft when the shaft rotates.

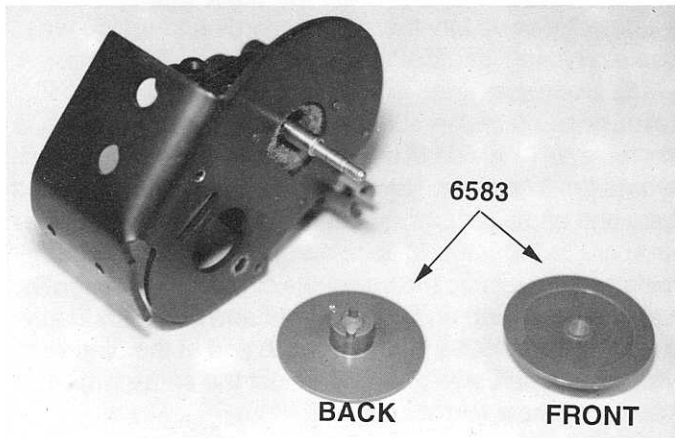

Fig. 63

Figs. 64 & 65 1) Now we need to remove the final #6596 3/16" x 5/16" unflanged bushing from bag B. (Both ball bearing and bushing kits use the same #6596 bushing for this assembly.) 2) From bag E remove the #6584 outer torque clutch hub, #6585 Rulon clutch disc, #6594 thrust bushing, two #6594 thrust bushing steel washers, #6587 torque control spring, and #6629 gold colored 5-40 steel locknut. **Note:** Associated's #6587 replacement part contains both the torque control spring and one #6629 5-40 locknut.

3) Fig. 64 shows both sides of the #6584 outer torque clutch hub, the #6585 Rulon disc, and both parts assembled together. To install the Rulon disc, place it over the recessed area on the back side of the outer torque clutch hub. Make sure the disc is centered on the hub.

4) Now turn the disc and outer hub over. Fig. 65 has

the parts laid out in the order we are going to install them onto the drive gear/shaft. Place the #6596 bushing into the hole of the outer clutch hub. 5) Install the clutch hub and bushing onto the gear shaft, making sure the Rulon clutch disc is still centered on the hub. Make sure the bushing goes over the larger portion of the gear shaft and that the outer edge of the bushing is slightly below the surface of the clutch hub when properly installed. 6) Now install one of the #6594 steel thrust bearing washers. This will be just about even with the outer edge of the hub when installed. 7) This is followed by the #6594 bronze thrust bushing and 8) the second steel thrust bearing washer. **WARNING!! Do not mix up the special hardened steel thrust washers from bag E with any other washers in the kit. Using the wrong washer will ruin the thrust bushing and reduce clutch performance.**

9) Now install the #6587 torque control spring and 10) #6629 5-40 gold colored 5-40 locknut. 11) Tighten the nut until at least 1/2 of a thread is exposed outside the nut. This will just be a starting point for the torque clutch until we make the final adjustments later in the manual.

Cliff Lett's Racer's Tip: "Like any other spring, a new slipper spring will 'take a set' after use. This means that it will be slightly shorter after being fully collapsed, but its spring rate will be the same. You can bypass this change problem by collapsing the spring a couple of times yourself using your pliers. Collapsing the spring now will prevent it from doing so after you have built the car and run it a few times."

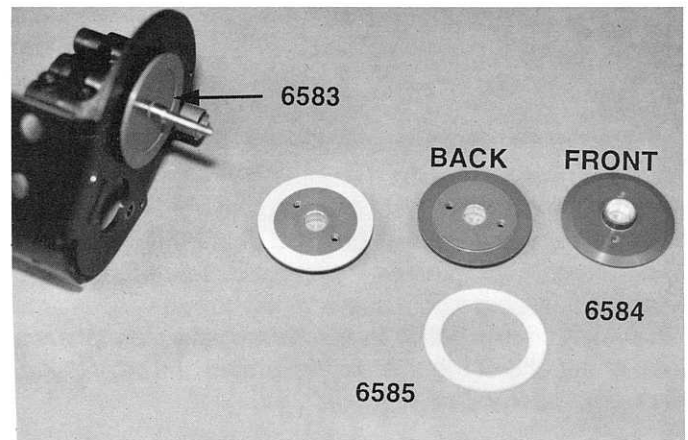

Fig. 64

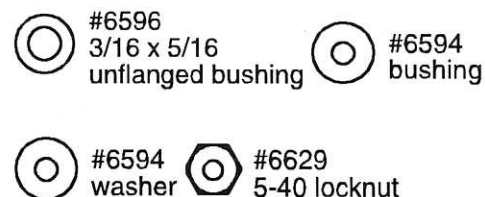
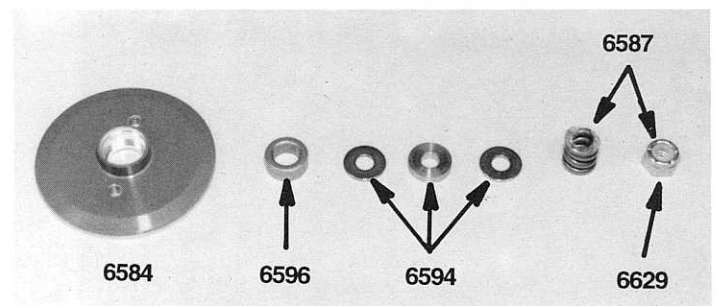



Fig. 65

□ **Fig. 66** Open bag #8-15 and remove the #6693 81 tooth 48 pitch spur gear. From bag F remove the two #6568 4-40 x 3/16" button head socket screws. The photo shows both the front and back side of the spur gear. Mount the spur gear with the back side towards the clutch hub. Line up the two mounting holes of the spur gear with the two mounting holes in the outer clutch hub. Make sure the spur gear is pressed on as far as possible and as evenly as possible before installing the two #6568 screws. Now do your best to tighten the two screws evenly so the spur gear will not try to warp. *Racer's Tip: These screws are subjected to a lot of vibration so make sure you check them for tightness frequently.* Your completed tranny with spur gear installed will look like fig. 66.

 #6568
4-40 x 3/16

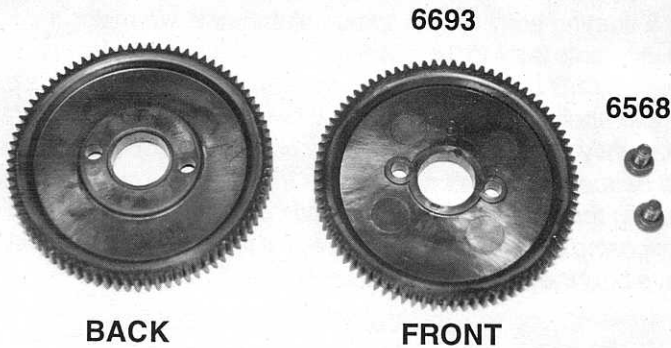

Fig. 66

□ **Fig. 67** Locate the #6575 diff bolt thrust cover we set aside in fig. 43. Install this dust cover into the right diff outdrive over the head of the diff thrust bolt (flat side out). This is the same side as the spur gear, or the opposite side of the T-nut. Your transmission is now completed. If you have any questions about the transmission, refer to the tuning and maintenance section near the end of the manual. Go ahead and set it aside. We will install it later in the manual.

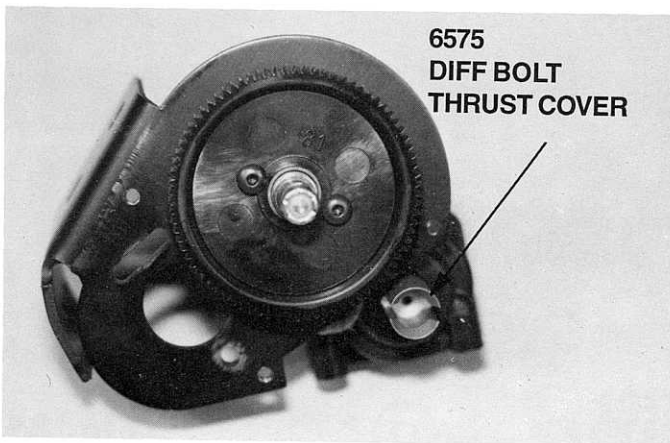

Fig. 67

REAR END ASSEMBLY

□ **Fig. 68 & 69** 1) Now open bag #8-8 which has all the rear end parts. Remove the two #8860 rear suspension arms, two #8862 rear inner hinge pins, two #8864 rear outer hinge pins, the #6360 rear suspension mounts, and four #6299 1/8" E-clips. Remember, the E-clips will be a very small roll held together with white tape.

2) We also need to open bag #8-12, which contains the rear anti-roll/sway bar parts, for a moment. We want to remove two #6270 short ball ends. 3) Look at the front of the rear suspension arms. There are three mounting holes in the arm. Thread one #6270 ball end into the middle mounting hole of each rear arm. Now set bag #8-12 aside we will come back to it shortly.

4) Next, trim the molding runners from the two #8860 rear suspension arms. 5) Check the pin fit on the rear suspension arms just as we did on the front suspension arms. Refer back to fig. 12 and follow the same procedures to make sure that both inner and outer pins pivot freely in both arms. Set the #8864 pins aside; we will not need them for a couple of steps.

6) Now trim the mold runner that connects the #6360 rear suspension mounts together. 7) Each rear mount has 1.5° of rear toe-in built in, giving the car a total of 3° of rear toe-in. This means there is a right and left mount. These can be identified by looking for the "R" and "L" molded into the bottom of the mounts. To make sure that everything is laid out correctly, the front of each mount is thicker than the back when looked at from a side edge view. Lay them out according to fig. 68 when you have everything identified.

8) Both rear arms are identical so it will not matter which arm goes on which side until they are attached to the rear arm mounts. The side of the arms with the mounting holes will become the front side. Now start with the right side mount and place one of the rear arms around the mount so the holes in the arm are to the front. 9) Take one of the #8862 rear inner hinge pins and slide it into the back hole of the arm, through the rear suspension mount, and out the front arm hole. 10) Center the pin and install a #6299 E-clip on each end of the hinge pin. 11) Assemble the left side arm and mount the same way. Just remember, it will be a mirror image.

 #6270
4-40  #6299
e-clip
1/8 shaft

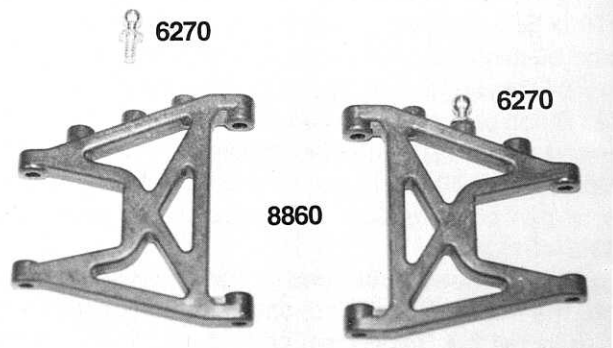

Fig. 68

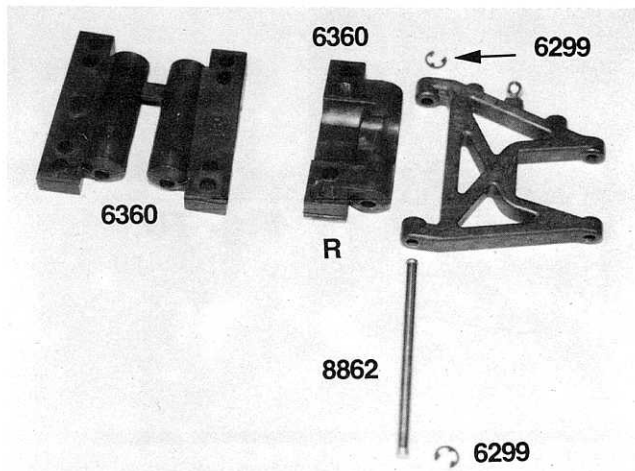
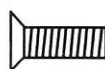



Fig. 69

Fig. 70 Remove the four #6280 8-32 x 1/2" aluminum flat head machine screws and two #8182 8-32 aluminum plain nuts (bag #8-8). We are going to use the 8-32 screws to secure the mount/arm assemblies to the chassis. Again we will start with the left side. There are four holes in each mount. Line up the back mounting hole of the rear mount with the back mounting hole in the chassis. Use a second #6280 screw and install it into the front mounting hole. This will put the mounts in the forward position. Now repeat these steps to install the right mount/arm assembly. Now install the two 8-32 plain nuts by threading them onto the back screw of each mount.

-  #6280 8-32 x 1/2 aluminum
-  #8182 8-32 plain nut aluminum

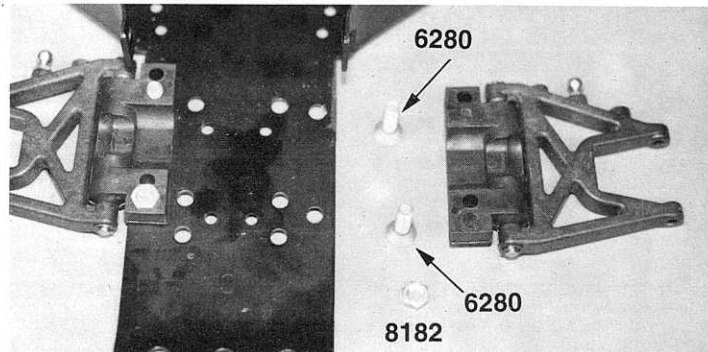



Fig. 70

Fig. 71 Remove the #6323 nylon rear bulkhead from bag #8-8. We need to go back to bag #8-14 and remove two #6273 long ball ends, two #6272 foam ball end dust covers, and two #7260 4-40 small pattern plain nuts. The photo shows you which side is the front and which is the back of the bulkhead. There are five holes on each side of the bulkhead that can be used to mount the ball end. We are going to use the middle hole of the three holes on the top horizontal row (not the vertical row). Thread the ball end in from the back side and then thread the #7260 nut onto the exposed threads on the front side. After both ball ends are installed push the foam ball end dust covers over the end of the balls.

-  #6273 4-40
-  #7260 4-40 plain nut

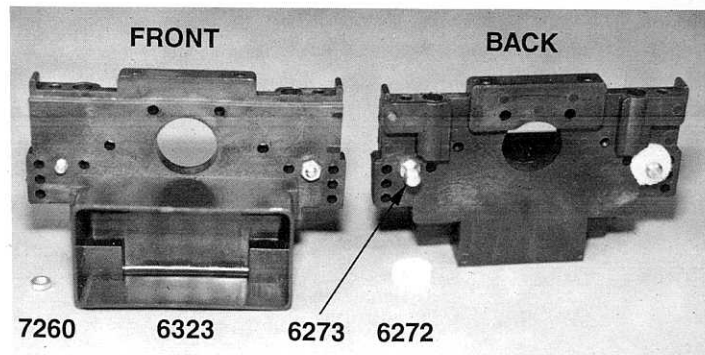



Fig. 71

Fig. 72 From bag #8-12 remove the #8872 rear anti-roll bar wire, two #8830 aluminum roll bar pivots, and two #6951 4-40 x 1/8" socket set screws. Slide the #8830 roll bar pivots onto each end of the roll bar wire so that the ball portion is to the outside. Install one #6951 set screw into each aluminum ball pivot, line the end of each pivot up with the end of the roll bar wire and tighten up the set screws.

-  #6951 set screw

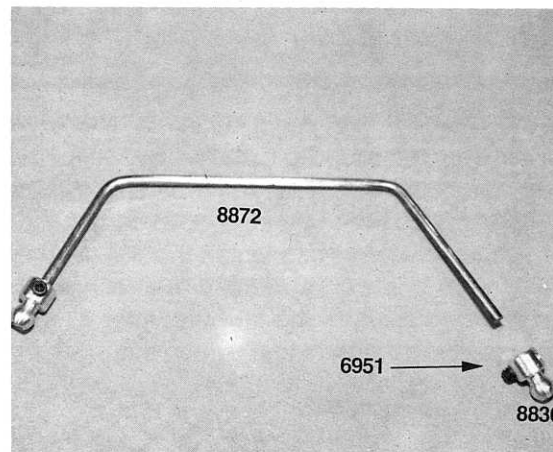

Fig. 72

Figs. 73 & 74 Remove the #8870 molded rear shock strut and four #6925 4-40 x 1/2" socket head cap screws from bag #8-8. In the photo you will see both the front and back sides of the rear shock strut. The back side can be identified very easily by the two molded locator pins that are used to hold the rear anti-roll bar in place.

Now pick up the #8870 rear bulkhead and place it in front of you. On the front of the bulkhead, at the top, you will find a recessed ledge shown by an arrow. Place the center of the roll bar wire on the ledge with the pivots facing forward. Now pick up the #8870 shock strut and place it in between the ends of the roll bar, making sure the locator pins, on the back side, are going over the roll bar wire. Line up the four holes in the rear strut with the four holes in the rear bulkhead and secure the strut to the bulkhead with the four #6925 4-40 screws as shown.

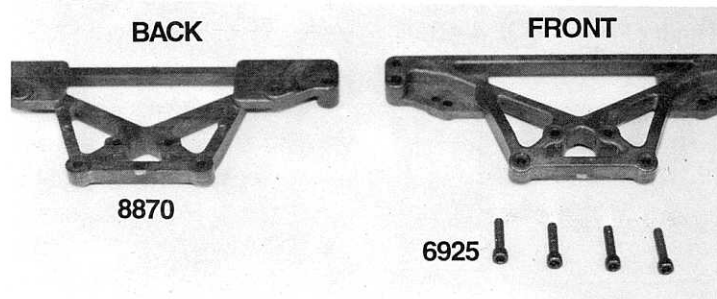

Fig. 73

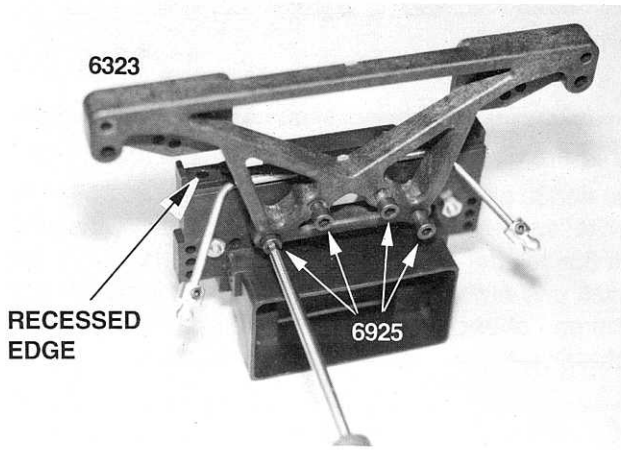



Fig. 74

 #6925
4-40 x 1/2

Fig. 75 & 76 We want to install the #6323 nylon rear bulkhead and anti-roll bar now. Remove two #6280 8-32 x 1/2" aluminum flat head machine screws and two #6925 4-40 x 1/2" socket head cap screws from bag #8-8. We are going to use the two #6280 aluminum screws to fasten the bulkhead to the bottom of the chassis and the two #6925 4-40 screws to fasten the bulkhead to the sides of the chassis. After all four screws have been installed go ahead and tighten them.

 #6280
8-32 x 1/2
aluminum

 #6925
4-40 x 1/2

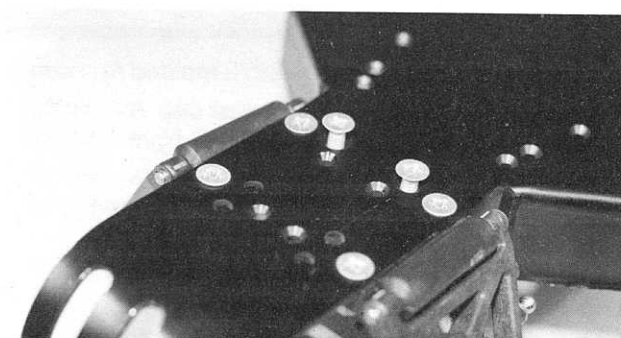

Fig. 75

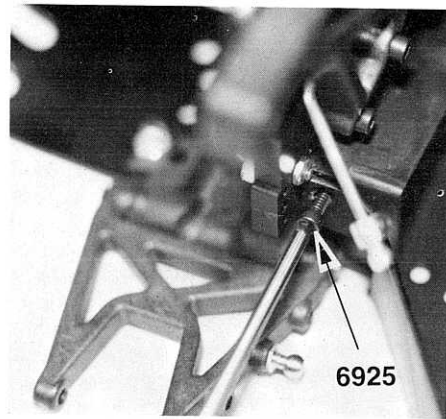

Fig. 76

Fig. 77 & 78 In bag #8-12 you will also find two #6385 4-40 x 1 1/4" threaded rods and the parts tree containing the #8828 molded roll ball cups. Again the parts tree contains two each of the open ball cups and two of the closed ball cups. Thread one closed and one open ball cup onto each #6385 threaded rod until the ball cups bottom out.

To install the threaded ball cup links we just assembled, snap the closed end ball cup onto the #6270 ball end on the rear suspension arm. Then slide the open ball end cup over the aluminum roll bar pivot. After you have installed the second link you will now have a completed rear anti-roll bar assembly.

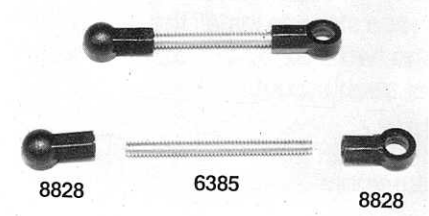

Fig. 77

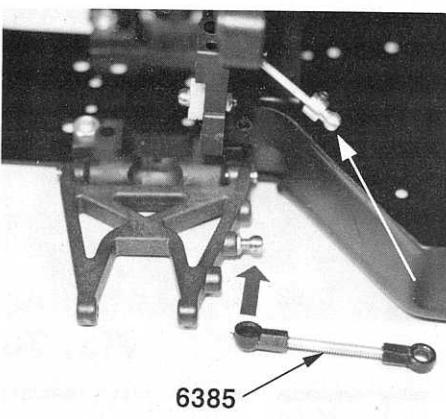

Fig. 78

Fig. 79 & 80 We are now ready to install the Stealth transmission. In bag F of the Stealth main bag you will find four #6292 4-40 x 3/8" flat head socket screws. Place the transmission between the two rear suspension mounts so that the spur gear is on the right or passenger side and the curved part of the motor plate is inside the rear curved portion of the chassis. While holding the transmission against the chassis turn both of them over. Now take the four #6292 screws and secure the transmission to the chassis as shown. Do not tighten these screws just yet.

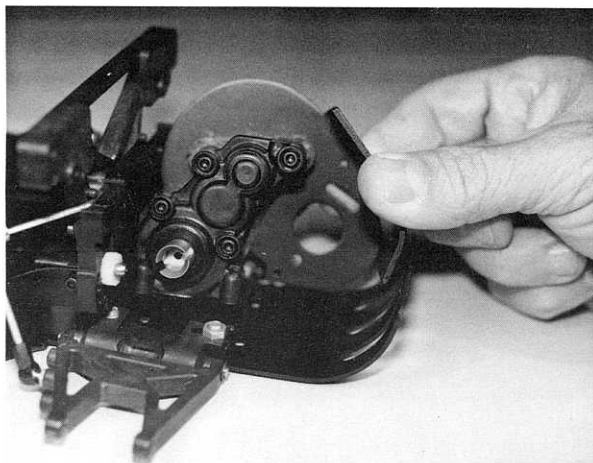

Fig. 79

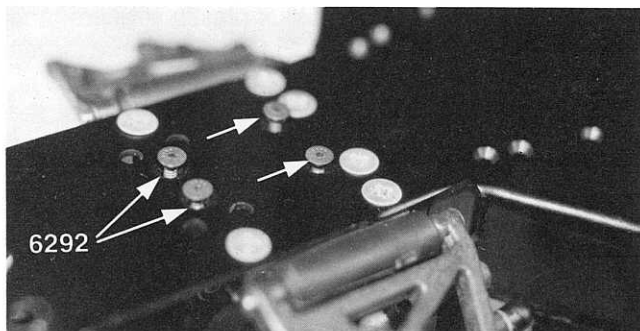

Fig. 80

□ **Fig. 81** Also in bag F you will find two #6288 4-40 x 1/4" button head socket screws. If you look at the back of the chassis you will see that there are two holes. We will use the #6288 screws to secure the chassis to the motor plate. Make sure the motor plate fits inside the chassis as shown then thread the two #6288 screws into the motor plate. This is the reason we did not tighten up the transmission mounting screws. After both screws have been started go ahead and tighten them both. Now you can go back and tighten the four #6292 screws we used to mount the transmission to the chassis.

□ #6288
4-40 x 1/4

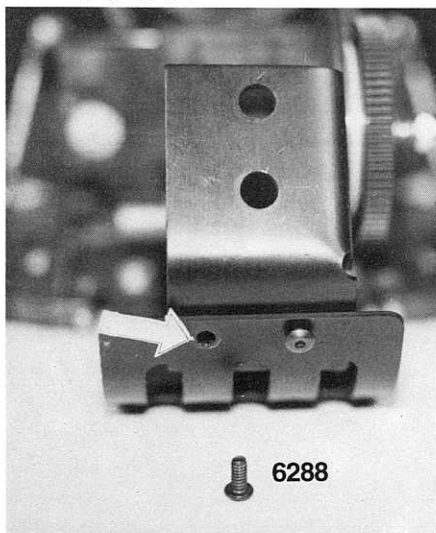

Fig. 81

□ **Fig. 82 & 83** In bag #8-8 you will find the #6325 nylon transmission brace, two #6932 4-40 x 5/16" socket head cap screws, and two #6925 4-40 x 1/2" socket head cap screws. Look at the brace, you will find two holes on the flat end and four holes on the contoured end. The flat end will go over the top of the rear bulkhead and the contoured end will go over the transmission. Use the two #6932 5/16" length screws to secure the brace to the transmission and the two #6925 1/2" screws to secure it to the bulkhead.

□ #6932 4-40 x 5/16 □ #6925 4-40 x 1/2

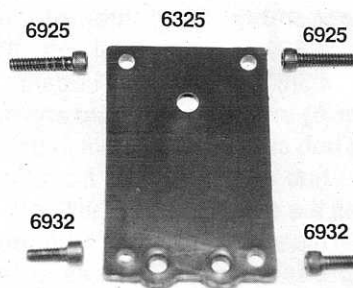

Fig. 82

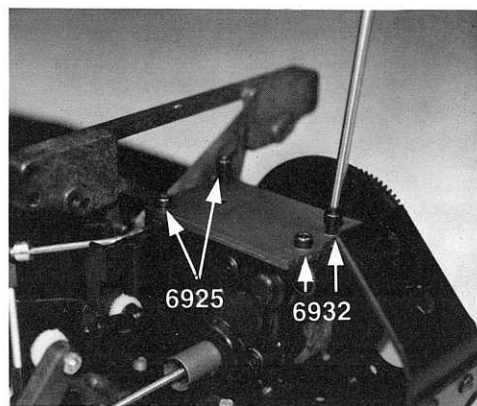

Fig. 83

□ **Figs. 84 & 85** We will now need to start assembling the rear axles and hub carriers. Depending upon which model of the RC10DS you own, you will have different parts for this assembly. If you look at fig. 84 you will see the parts for assembling the rear axle for both the bushing and ball bearing kits. **Note:** The photos after this step will only show the installation of the dogbones and stub axles in order to save time and space.

1) From bag #8-8 remove the two #7365 0° rear hub carriers. 2) Depending upon your kit you will also need to remove the following parts:

For the bushing kits: also remove the two #8868 rear stub axles, two #7368 3/16" axle shims, two #7369 1/16" rear axle spring pins, and the small bag with the four #6599 3/16" x 3/8" unflanged bushings.

For the ball bearing kits: also remove the two #8869 universal dog bone axles, twelve #7368 3/16" rear axle shims, two #7377 rear axle bearing spacers, two #7369 1/16" rear axle spring pins, and the small bag with the four #6906 3/16" x 3/8" unflanged ball bearings.

3) Fig. 84 shows the parts laid out in the order they will be assembled. The hub carrier will be the same for both but the

parts at the top of the photo are for bushing kits and the parts at the bottom of the photo are for ball bearing kits.

Bushing kit axle assembly: Slide one of the #6599 3/16" x 3/8" unflanged bushings onto the #8868 rear stub axles. 4) Slide the threaded end of the stub axle through the back side of the #7365 0° rear hub carrier and press the parts in until the bushing seats into the rear hub carrier. 5) From the front, slide on the second #6599 bushing and seat it into the front of the #7365 hub carrier. 6) This will be followed by one #7368 3/16" rear axle shim and 7) the #7369 rear axle roll pin, which you press in the hole with your needlenose pliers. 8) Repeat the process to assemble the second axle. At this point both axle assemblies are interchangeable for both the right and left side. Finish the assembly below under "Both kits."

Ball bearing kit axle assembly: Slide three of the #7368 rear axle shims onto the #8869 rear universal axle. 4) Follow this with one #6906 3/16" x 3/8" unflanged ball bearing 5) and the #7377 rear axle spacer. 6) Install the threaded end of the axle into the back of the rear hub carrier and push it in until the #6906 bearing seats into the hub carrier. 7) Now from the front side of the hub carrier install the second #6906 ball bearing and seat it into the front. 8) This will be followed by three more of the #7368 rear axle shims and 9) the #7369 rear axle spring pin, which you will press into the hole on the axle with your needlenose pliers. 10) Repeat the process for the second axle assembly. Again there is no right or left axle assembly at this point.

Both kits: Now go to bag #8-14 and remove two #6273 long steel ball ends, two #6272 foam ball end dust covers, and two #7260 4-40 small pattern plain nuts. Thread one #6273 ball end into each hub carrier, but from opposite sides. Now you can thread one #7260 4-40 plain nut onto the ends of the threads. After you have installed the ball ends you can finish by installing the #6272 foam ball end dust covers. Now you will have a right and left rear hub carrier/axle assembly. Please do not get them mixed up.

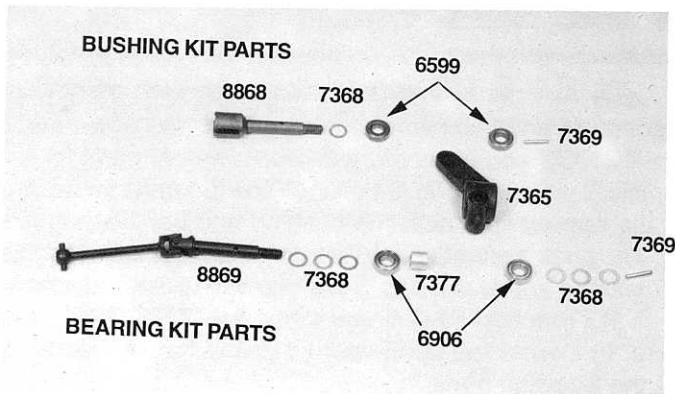

Fig. 84

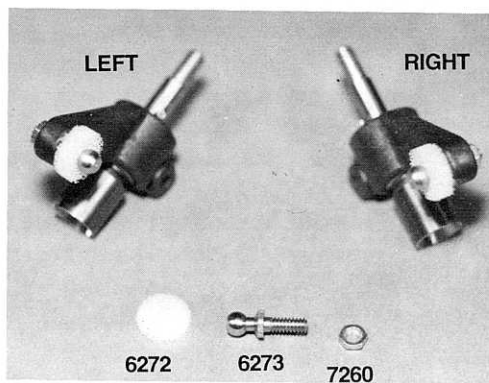
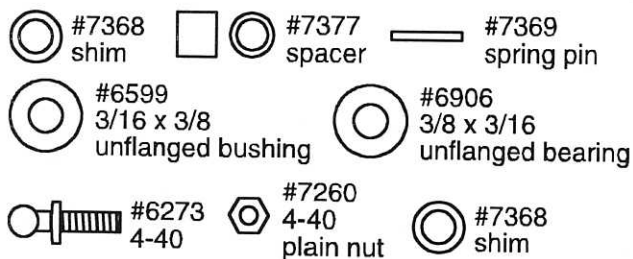

Fig. 85



Fig. 86 & 87 1) Remove the two #8864 rear outer hinge pins, two #6466 1/8" (.125") black plastic spacers, and four #6299 1/8" E-clips from bag #8-8. 2) (Fig. 86.) Place the left rear hub carrier assembly between the outer mounting holes on the left rear suspension arm. Move the assembly against the front mounting hole. 3) Use one of the 1/8" spacers to take up the gap between the hub carrier and the back mounting hole on the suspension arm. 4) We can now install the #8864 outer hinge pin through the back mounting hole, then through the plastic spacer, the rear hub carrier and out the front arm mounting hole. 5) Now center the pin and install an E-clip onto each end of the #8864 pin. 6) Repeat the above steps to install the right side parts. Make sure that you keep the hub carrier/axle assembly against the front mounting hole on the arm.

7) Locate the two #8867 dogbones in bag #8-8. We must insert the dogbones into the slots in the transmission outdrives and the rear axles. Remember, if you have a ball bearing kit your universal axle will only have to fit into the slots of the transmission outdrives, because the other end of the axle and dogbone are connected by a universal pivot.

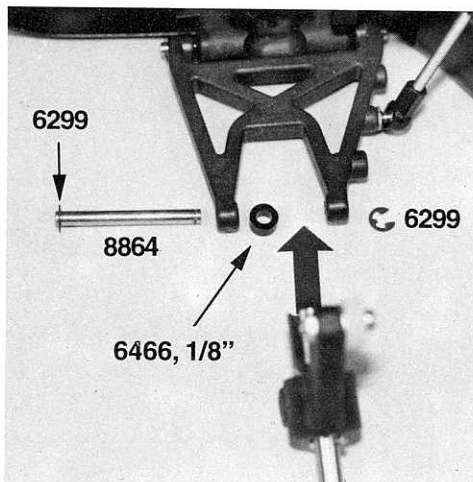

Fig. 86

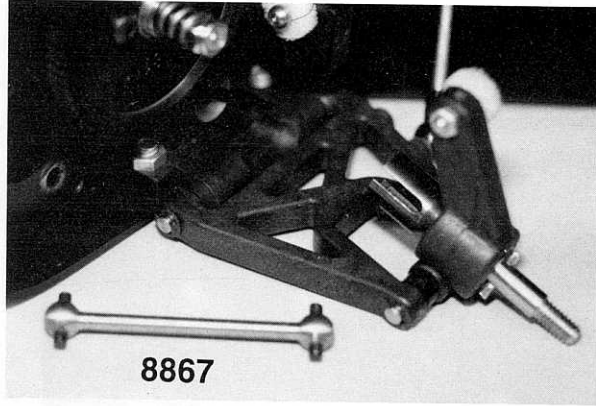

Fig. 87

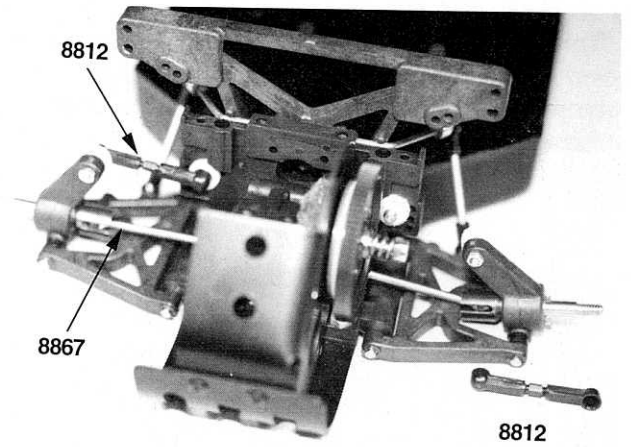

Fig. 89

SHOCK ASSEMBLY SECTION

The Dual Sport uses our current generation of improved shocks, which we have used on all of our cars and trucks for several years. We feel these are still the best shocks in the industry. If you have a bushing kit your shocks will have our standard gold anodize finish. If you have a Team kit your shocks will be the same but they will have our hard anodized Teflon sealed finish. If you have built these shocks before you should have no assembly problems. If this is the first set of our shocks that you have built, take your time and follow the written instructions carefully. There are a couple of key areas that people have problems with because they forget how critical the fit can be on some of these parts. So pay close attention.

Again this is an area where we will have different parts for bushing and bearing kits. Please note which items will be in the kit that you purchased as you assemble your shocks.

❑ **Figs. 90 & 91** Inside the kit bag you will find what we call the master shock bag. Inside this bag you will find several bags. These bags will consist of bag #8-9, bag #8-10, and the shock seal parts bag. You will also find the #6429 plastic shock seal assembly tool in the master shock bag.

1) Open bag #8-9 and bag #8-10. Remove two new #8844 shock shafts from each bag. These shock shafts were designed just for this car. 2) Now open the shock seal assembly parts bag and remove the roll of #6299 1/8" E-clips. 3) Install one E-clip into the bottom groove on each shock shaft (the groove closer to the threaded end) as shown. 4) Go back to bags #8-9 and #8-10. Inside each bag you will find two #6464 #1 shock pistons. Take out all four.

5) The new molded pistons are designed to help eliminate the possibility of burrs on the edge of the piston. A burr on the piston edge could reduce the shock's smoothness and performance. Remove four shock pistons from the parts tree by twisting the piston up as shown in fig. 91. Twisting the piston down will leave a rough edge on the piston and will make the shock inconsistent. If there are any burrs, **carefully** remove them with a sharp hobby or X-acto© knife.

5) We can now install the four #1 pistons onto the four

❑ **Fig. 88 & 89** 1) Remove the two #8812 turnbuckles from bag #8-8. 2) Go back to bag #8-14 and remove four #6274 plastic ball end cups. 3) Thread the #6274 plastic ball end cups onto the two #8812 turnbuckles. When assembled these will become our rear camber rods. 4) Adjust the length for these turnbuckles (center of the ball cup hole to the center of the other ball cup hole) to 1 1/4" (1.25" or 31.75mm). When these turnbuckles are assembled correctly the ball cups will be facing opposite directions. (If you are not sure you remember the proper procedures for adjusting the turnbuckles please refer back to fig. 18 and follow the steps indicated there.)

5) After you have assembled and adjusted the turnbuckles we can proceed to install them. Start by snapping one end onto the inside ball first. 6) Before we snap the other end on, double check to make sure the dogbone is still inserted into both the outdrive and axle. 7) Now we can snap the second ball cup onto the ball end on the rear hub carrier. **Note:** because of limited space you may need to use your needlenose pliers to install the inside ball end cups. **WARNING! The front and rear camber rods use the same #8812 turnbuckles but the adjusted length is different. Please do not get them mixed up or your front and rear camber will be off.**

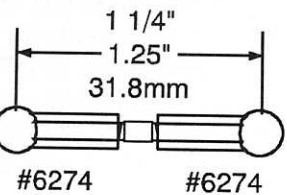
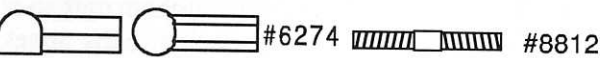

Fig. 88

#8844 shock shafts. **6)** Secure each piston to the shock shaft by installing an E-clip into the second groove above the piston.
Racer's Tip: We recommend having the molded number of the piston facing up so you can see which piston you are currently using when you service your shocks. Otherwise, it does not matter which way they face.

#6299
 e-clip
 1/8 shaft

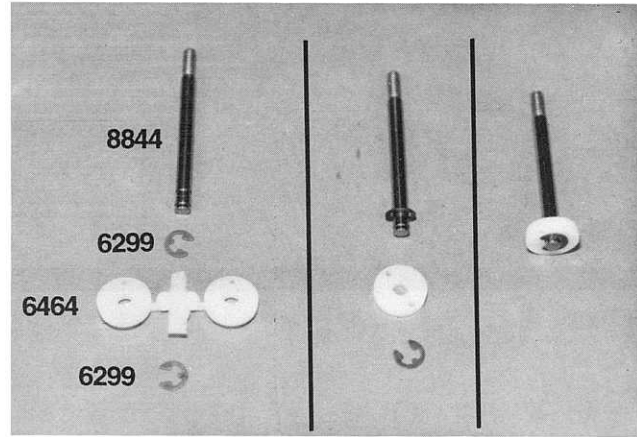

Fig. 90

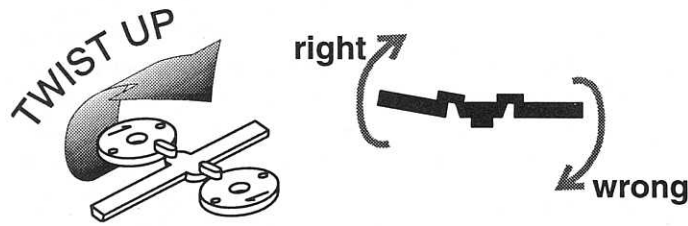

Fig. 91

Fig. 92 & 93 1) Go back to the shock seal bag and remove the #6440 shock seal parts tree and the eight #5407 red O-rings. The molded parts tree contains only enough parts to assemble four shocks. Be careful not to damage or lose any.

WARNING! BECAUSE OF THE PRECISION TOLERANCES OF THESE NEW PARTS, CORRECT REMOVAL OF THE PARTS FROM THE PARTS TREE IS **CRITICAL!** Using an X-acto® knife with a very sharp blade, carefully trim each part from the parts tree. IT IS **EXTREMELY IMPORTANT** THAT NO PART OF THE TWO MOLDING RUNNERS REMAIN ON ANY PART. IF YOU ARE UNCERTAIN IF ALL OF THE RUNNER HAS BEEN REMOVED, IT IS SAFER TO REMOVE A TINY AMOUNT OF THE PART (WHERE THE MOLD RUNNER WAS ATTACHED) THAN TO TAKE A CHANCE ON THERE STILL BEING A BURR ON THE PART. Any part of the mold runner remaining will prevent the parts from snapping in correctly, causing the shock to leak or the shock shaft to bind. EITHER PROBLEM WILL REDUCE THE PERFORMANCE AND DURABILITY OF THE SHOCK. Because they are so small that you cannot see them, the only way to find the burrs is to run your finger around the edge of the part. Remove any burrs you find.

2) Now remove the #6429 plastic shock assembly tool from the shock master bag. Fig. 95 shows the parts laid out in

the order they will be installed onto the assembly tool. They go on in this order, from left to right: 1) split locking washer, 2) small molded washer, 3) red O-ring, 4) large molded spacer, 5) second red O-ring, 6) and second small molded washer. You can also compare the sequence in fig. 93.

#5407
 red O-ring

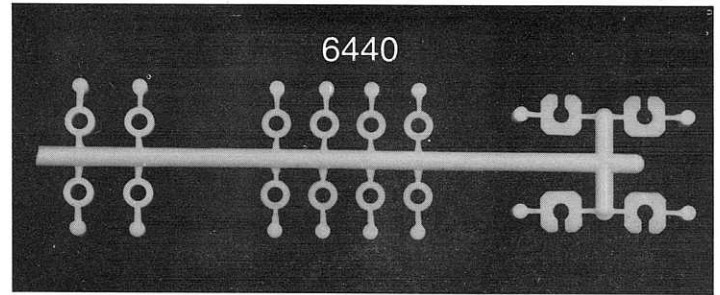

Fig. 92

Fig. 92 Left: 4 large nylon spacers
 Fig. 92 Center: 8 small nylon washers
 Fig. 92 Right: 4 split washers

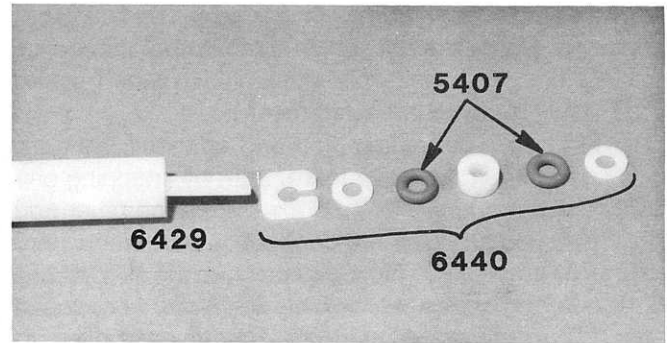

Fig. 93

Figs. 94 & 95 HOW TO DISMANTLE THE SHOCK SEAL PARTS Fig. 96 shows a cutaway of the bottom portion of the shock body showing how all of the parts fit into the shock seal cavity. Fig. 97 is the same cutaway drawing depicting the shock assembly tool being used to remove the shock seal parts.

In order to dismantle the shock seal parts you must 1) remove the shock cap, 2) drain the shock oil, 3) remove the shock shaft with piston, 4) insert the small angled tip of the shock tool into the bottom of the shock, sliding the tool all the way in until the tool bottoms out against the shock body. 5) Now angle the tool slightly and slowly slide the tool out of the shock body until the tip slides over underneath the split washer and the first small molded washer (fig. 97). 6) Now with the pointed tip of the tool under one side of the split locking washer, push firmly up until the split washer snaps out of its groove. 7) Once the split washer is loose, pull the tip of the tool down and use it to push the rest of the internal parts out of the shock body cavity.

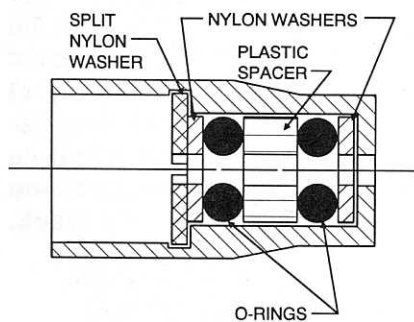

Fig. 94

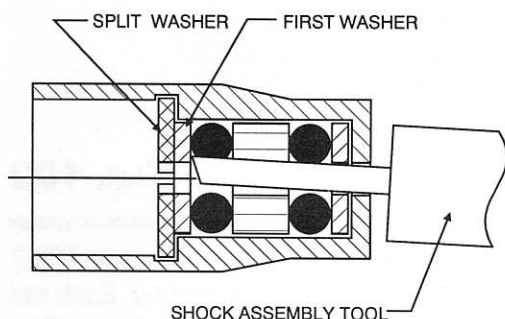

Fig. 95

have the parts snapped in correctly, or there are still burrs on either the small molded washers or large molded spacer. **9)** Now look inside the shock body for any obvious signs that indicate the parts did not go together correctly. **10)** Now go back and repeat the previous steps for the other three shocks.

Fig. 99 shows a close up view of the two small washers used with the red O-rings. The washer on the left still has two small burrs on it while the one on the right side of the photo has had all of the burrs removed. The arrow in the photo points to one burr and the second burr is directly opposite on the other side of the same washer.



Fig. 96

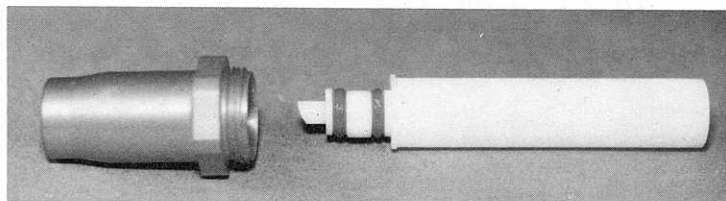

Fig. 97

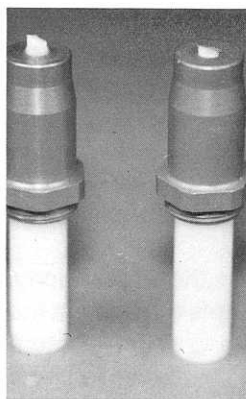

Fig. 98

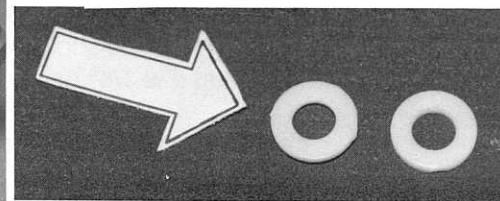

Fig. 99

□ Figs. 96, 97, 98 & 99 **1)** Open bag #8-11 and remove the bottle of 20 weight silicone shock oil (fig. 96). This is the recommended starting weight for this car with the supplied pistons. (When you run out of the oil supplied with the kit, the part number for a 2 ounce replacement bottle is #5421.)

2) Go back to bag #8-9 and #8-10 and take out two shock bodies from each bag. (They are all the same length.)
Bushing kits: #6427 .56" stroke gold anodized shock bodies.
Ball Bearing kits: #6438 .56" stroke hard anodized Teflon sealed shock bodies (dark green to medium grey in color).

3) Put a couple of drops of the silicone oil into each shock body just before you install the seal parts. The oil coats the inside of the seal cavity in the shock body. This helps prevent damage to the O-rings as they are being inserted.

4) Set the body down for a second and then pick up the shock assembly tool with the seal parts on it. Now place one or two drops of oil on the seal parts so we can insert them into the shock body. **5)** Pick up the shock body and line it up with the shock tool (fig. 97). Slowly insert the tool into the shock body, rotating the shock body as you are installing the seal parts into the cavity. This makes it harder for the O-rings to cut or tear on the edge of the cavity during the assembly. **6)** As you reach the bottom of the shock body you will need to line up the seal parts with the cavity that they will be going into. If everything goes in properly, the bottom edge of the beveled tip of the assembly tool will be almost flush with the bottom of the shock body as shown on the right side of fig. 98.

7) Now stand the shock tool on your work bench with the shock body on top, and push down firmly on the shock body. We want to hear and feel the split washer snap into its groove. The split washer is made of a hard material, so it might take quite a bit of pressure before it will snap into place. The end of the tool will be sticking out the bottom of the shock at least 1/8" when properly installed as shown on the left side of fig. 98. **8)** The tool should slide out easily. If it does not, then you may not

□ Figs. 100 & 101 In both bag #8-9 and #8-10 you will find a small bag containing four small 1/32" thick plastic washers. We will use these as shock travel limiters. We will only need a total of four during assembly. Place the others in your tool box so you will have them for any future shock tuning on your car. We will need to install one onto each shock shaft before we can insert the shaft into the shock body. Now place a drop of oil on the threads on the shock shaft before we insert it into the shock body. When the threads reach the seal parts, take your time and be careful so that you do not damage the O-

rings. Once the threaded end of the shaft is through the seal parts, pull the shaft down until the piston and travel limiter stops against the split washer. Continue by doing the same for the other three shocks making sure the 1/32" travel limiter is on each shaft before it is installed.

Now we need to remove the four #6469 black O-rings from the shock seal parts bag. Install one on each shock body over the threads and seat it in the pocket at the bottom of the threads next to the hex portion of the body.

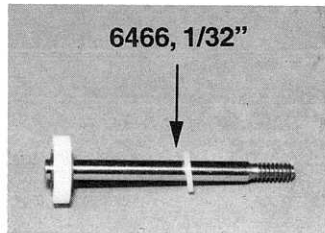
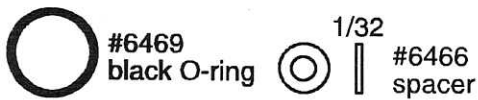

Fig. 100

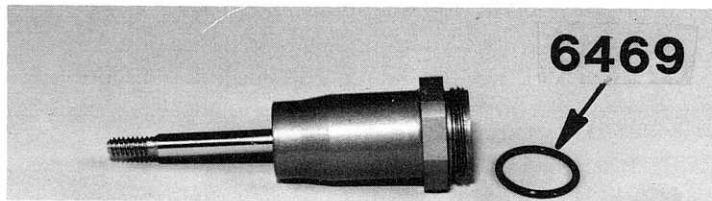

Fig. 101

Fig. 102 1) Again in both bag #8-9 and bag #8-10 you will find the shock caps. In the bushing kits they will be #6428 plastic shock caps. In the ball bearing kits they will be #6439 aluminum shock caps.

2) Place a couple of drops of shock oil on the threads inside each shock cap. 3) Now stand up one of the shocks and fill it with the silicone shock oil. The oil level will be even with the top of the shock body. 4) Now move the piston up and down once to make sure there are no trapped air bubbles under the piston. If there were, then refill the shock to the correct oil level. Bring the piston up so that it is 1/4" below the top of the shock body.

5) Now thread the shock cap onto the shock body. Tighten the cap **BY HAND ONLY** until it bottoms out against the hex portion of the shock body. 6) When the cap stops, just turn the cap a little bit further to secure the seal. There should be no gap between the cap and hex portion of the body. The O-ring will be doing the sealing, so do not overtighten the cap, otherwise you may split the cap.

7) We now need to check the shock rebound. Take each shock and work the shaft up and down five or six times. 8) Now push the shaft all the way in until it stops or until you reach the threads on the shaft--then let go. We want the shaft to come back out of the shock body 1/4" on its own. If it didn't, then we need to make the following changes. a) Pull the shaft all the way down and then unscrew the shock cap. b) To adjust the rebound, raise or lower the piston height in the shock body before screwing on the shock cap. This determines the volume of air that will remain in the shock and ultimately how much re-

bound you have. To increase the rebound (if the shock shaft came out less than 1/4") you will leave the piston lower in the shock body, and to decrease the rebound (if the shaft came out more than 1/4") you will raise the piston in the shock body. c) Recheck the oil level and adjust as necessary each time, before you screw the cap back on. We want all four shocks to be as close to the same 1/4" rebound as possible. **The extra time spent here will make a big difference on the track.**

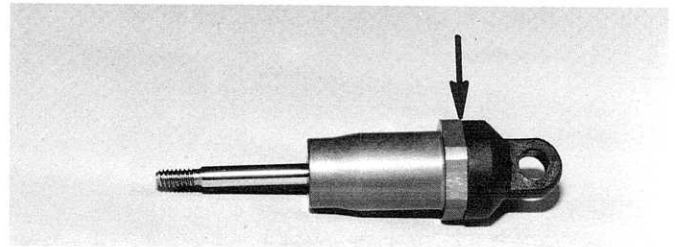

Fig. 102

Fig. 103 In bags #8-9 and #8-10 you will find two #7217 shock rod ends. Again there will be two in each bag. Each rod end consist of a nylon eyelet and a black plastic pivot ball as shown.

Take the #7217 nylon eyelet and push it over the plastic pivot ball. The easiest way to do this is to place the ball end on a table or bench, set the nylon eyelet over the ball and push down on the ball using a 1/4" nut driver. Make sure the ball is centered in the eyelet. You can also use needlenose pliers to squeeze the parts together; just take your time and use the smooth part of the jaws so you do not damage the plastic ball. Do the other three rod ends.

We will now thread the #7217 rod ends onto the shock shafts. To keep the shock shaft from turning, **grab the shaft only with the smooth part of the jaws on your needlenose pliers, and as close to the threaded end as possible.** This is very important. We do not want to scratch or damage the shaft. Shaft damage can ruin the O-rings, causing the shocks to leak.

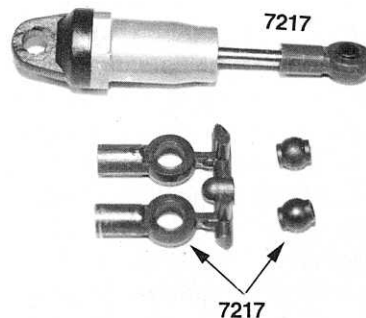

Fig. 103

Figs. 104 & 105 1) From bag #8-11 remove the #6474 spring clamps and cups (there will be two parts trees and each tree can do two shocks), you will also need to remove the new #8846 molded shock preload spacers, and four #8232 black

springs. **2)** You will find four different size preload spacers on the parts tree shown in fig. 104. The parts used are identified on the #6474 parts tree. The four sizes of spacers on the #8846 shock preload parts tree are numbered as follows: (1) 1/32", (2) 1/16", (3) 1/8" and (4) 1/4".

Remove one spring collar and one spring cup from one parts tree. **3)** Slide the spring collar over one shock and slide on one #8232 black spring (fig. 105). **4)** Compress the spring (towards the shock cap) and install one spring cup over the shock shaft and down over the #7217 rod end. **5)** Do the same for the other three shocks. At this point all four shocks are the same. **6)** After we install the different shock preload spacers you will then have front and rear shocks. We will start with the front shocks. Remove two of the 1/32" and two of the 1/16" preload spacers. **7)** Push the spring collar and spring down away from the hex, then snap one each of the 1/32" and 1/16" preload spacers over the shock body between the spring collar and hex portion of the body. **8)** After both have been pushed on the shock, release the pressure on the spring. The front shocks are now ready to install.

9) For the rear shocks remove two 1/16" and two 1/8" preload spacers. **10)** Compress the spring and install the spacers the same as you did for the front shocks. Now the rear shocks are ready to install on your car. Remember that the front and rear are now different because of the different preloads, so do not get them mixed up.

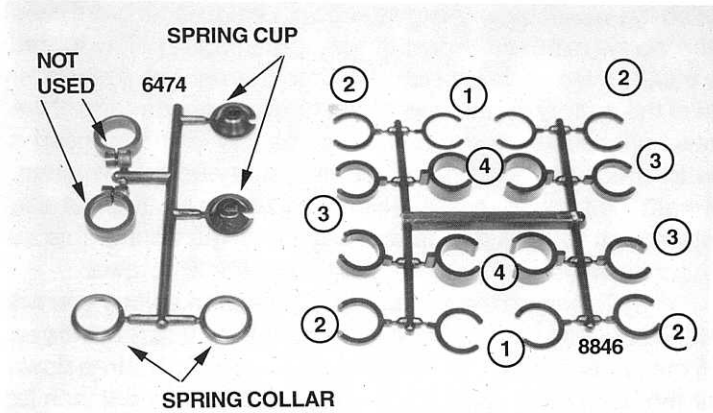

Fig. 104

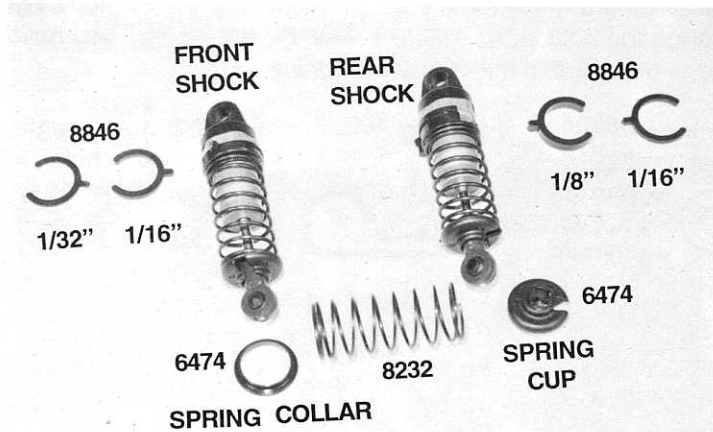

Fig. 105

4-40 x 3/4" socket head cap screws, four #6222 4-40/5-50 black nylon self threading locknuts, two #6925 4-40 x 1/2" socket head cap screws, and two #6473 nylon shock bushings. **2)** Thread the two #6927 screws into the front shock strut from the back side (fig. 106). This will place the threads on the front side of the car. **3)** Now thread one #6222 nylon locknut on the threads of each screw and tighten them. **4)** Now slide one #6473 shock bushing onto the threads of each screw, making sure you install the flanged end first. **5)** Pick up one of the shocks and slide the cap end over the threads and shock bushing. **6)** Thread another #6222 nylon locknut onto the end of the threads. **7)** Tighten the nut so that there is no movement of the bushing on the threads, yet not to the point where you begin to compress the shock bushing--which would cause binding. **8)** To mount the lower end of the shock we will install the #6925 socket head cap screw through the #7217 rod end pivot ball, and then thread the screw into the shock mount on the front suspension arm as shown.

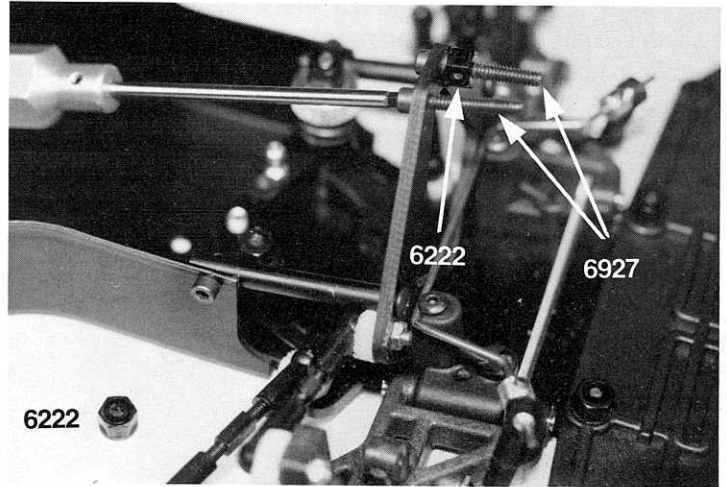

Fig. 106

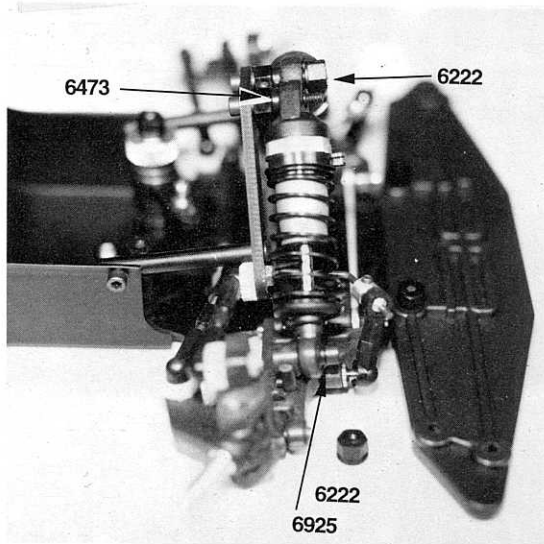

Fig. 107

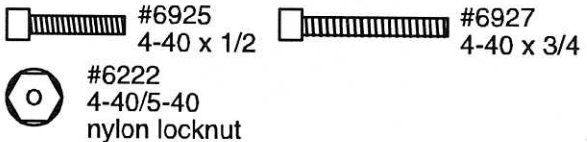

Fig. 106 & 107 **1)** We are now ready to mount the front shocks onto the car. From bag #8-10 remove two #6927

Fig. 108 & 109 1) Go to bag #8-9 and remove the two #6927 4-40 x 3/4" socket head cap screws, two #6222 4-40/5-40 black nylon self threading locknuts, two #6925 4-40 x 1/2" socket head cap screws, and two #6473 nylon shock bushings. 2) (Fig. 108.) If you look at the back of the rear shock strut you will find four holes on each side. There are two vertical holes at the outer edge and two holes in about 1/2" from the outer edge (these are the shock mounting holes). Install the 4-40 x 3/4" screws into the outer of the two shock mounting holes from the back so that the threads are over the rear anti-roll bar. Do both sides. 3) Because of the limited amount of room, you will have to use your Allen wrenches, and you will need to install the lower end of the rear shock first. Use the 4-40 x 1/2" screws and slide them through the shock rod end and thread them into the outer hole of the rear suspension arm. You may have to pull the rear suspension arm down to give you enough room to turn the Allen wrench without hitting the chassis.

4) Now take the two #6473 shock bushings and install them into the shock caps of the rear shocks. 5) Slide the shock cap and bushing onto the threads of the #6927 screws. For the rear we want to have the flanged side of the shock bushing away from the bulkhead. This means the cap will go on before the flanged side of the bushing. 6) Now secure the cap and bushing with the #6222 nylon locknut. Tighten the nut so that we take up any play around the shock bushing but not to the point where we begin to compress the shock bushing and cause binding.

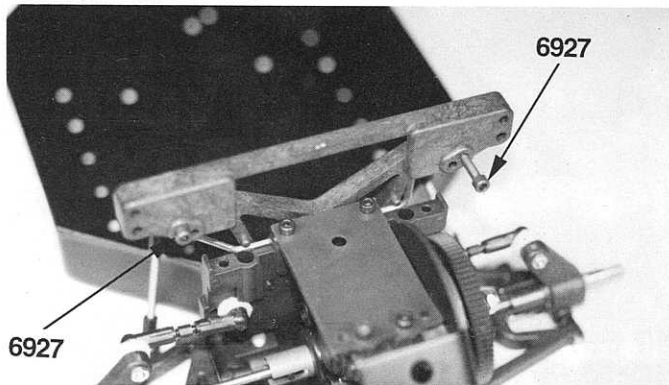

Fig. 108

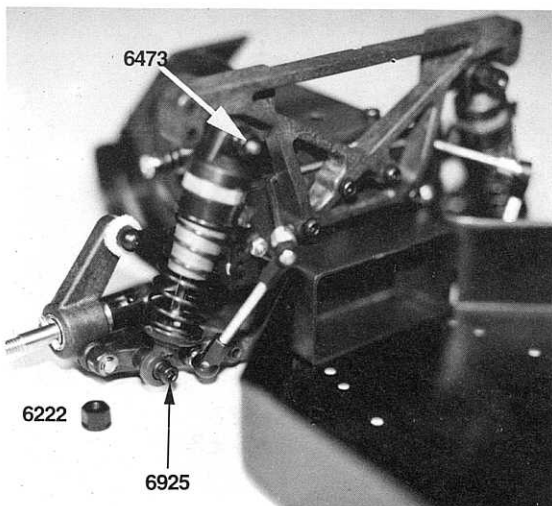
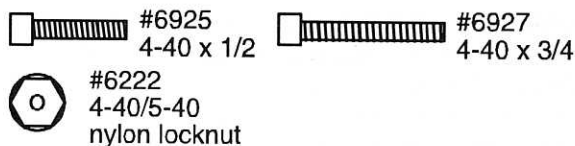

Fig. 109



BATTERY HOLDER ASSEMBLY

Fig. 110, 111 & 112 1) Open bag #8-7 and remove the #6334 battery cup and two #6922 4-40 x 1/2" flat head socket screws. Near the center of the chassis there are two holes for mounting the battery cup (fig. 110). 2) Place the cup in the chassis as shown and 3) secure it from the bottom with the two #6922 screws. These holes are countersunk to accept the screw heads.

4) In the same bag you will find the #6335 battery hold down strap, one #6924 4-40 x 3/8", one #6936 #4 aluminum flat washer, one #6332 body clip, and one custom #6929 4-40 x 3/8" socket head cap screw with hole. 5) Take the #6924 screw and slide the aluminum washer over the threads. 6) If you look at the battery hold down strap you will see that there are different shaped holes on each end. One will be round and the other will be keyhole shaped. Place this screw through the round hole of the battery strap and then thread it into the left, driver's, side hole on the #6334 battery cup as shown. Leave about one thread of the screw exposed above the battery strap. 7) Now thread the #6929 special screw with hole into the right or passenger side of the battery cup. Leave about three or four threads of the screw exposed. 8) If you have your battery you can insert it now to check the adjustments of the battery hold down strap. We want the strap to be easy to install over the battery, but also tight enough to hold the battery securely. You control this by how far down you tighten the #6924 and #6929 screws.

9) To secure the strap after it is over the battery you will need to squeeze the battery cup until the #6929 screw lines up with the larger portion of the keyhole slot, push the strap down over the head of the screw, and then release. This will then let the threads of the #6929 screw slide into the narrow section of the keyhole slot. The head of the screw will prevent the strap from sliding off. 10) Now you can install the #6332 body clip through the hole in the #6929 screw. Do not worry if you have one or two extra of the #6332 body clips.

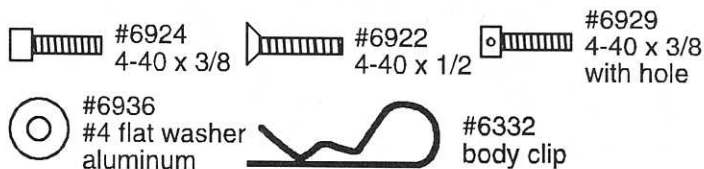

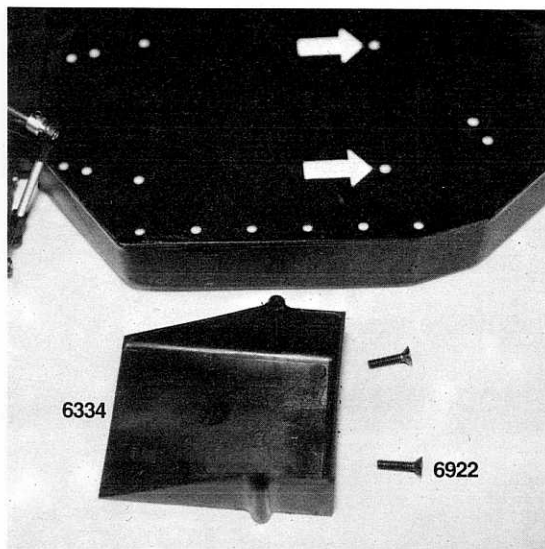

Fig. 110

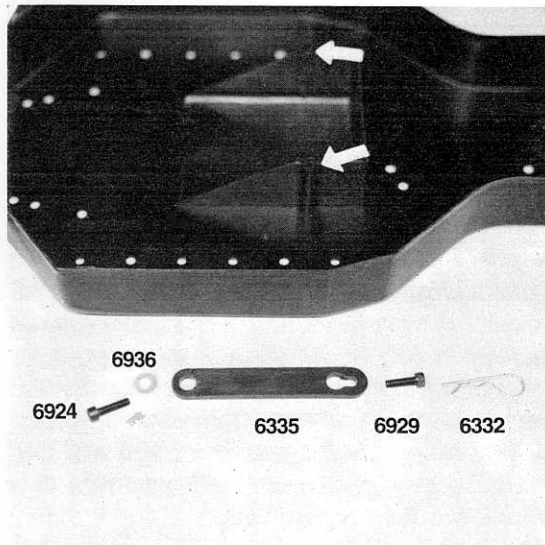

Fig. 111

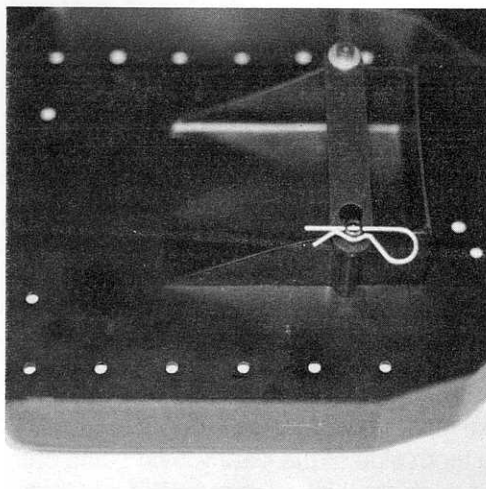

Fig. 112

BODY MOUNT ASSEMBLY

□ **Figs. 113, 114 & 115** 1) Take out bag #8-5, which contains the body mount parts. We will start by removing the two #8818 front body mount posts and two #6922 4-40 x 1/2" flat head socket screws. 2) If you look at the front bumper

you will find two mounting holes on each side. If you are mounting an SCCA Trans-Am style body we suggest you use the front two mounting holes. If you are going to use the DTM touring car style body you will want to use the back two mounting holes. Place the two #6922 screws through the correct holes for your body style and screw the #8818 body mount posts onto the screws. Line the body pin holes up so that they go across the car (left to right).

3) Go back to the same bag and remove the two #8874 rear body mount posts and two #7633 4-40 x 5/8" button head socket screws. 4) At the bottom of the rear body mount post you will find a small locator pin. This will go into the bottom hole of the rear shock strut when you mount the body mount post onto the back of the rear shock strut. 5) Now thread the #7633 screw into the rear body mount post from the front side of the rear shock strut. 6) Do the same for the second rear post.

7) Take out four #7320 body mount washers and eight #6332 body clips. Insert one body clip into the bottom hole of each body mount post. 8) Now slide on one of the body mount washers onto each body post. 9) Finally install one of the remaining four body clips into one of the holes above the body mount washers on each post. We will adjust the height of the parts on the body mounts, later, when we go to install the body.

#6922 4-40 x 1/2 #7633 4-40 x 5/8

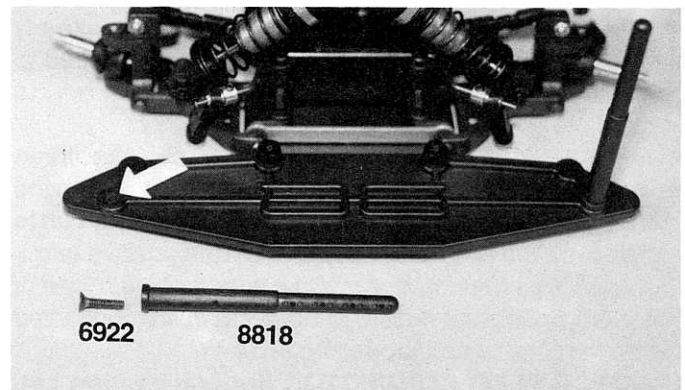
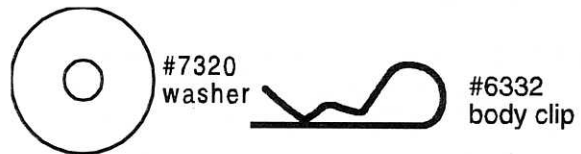

Fig. 113

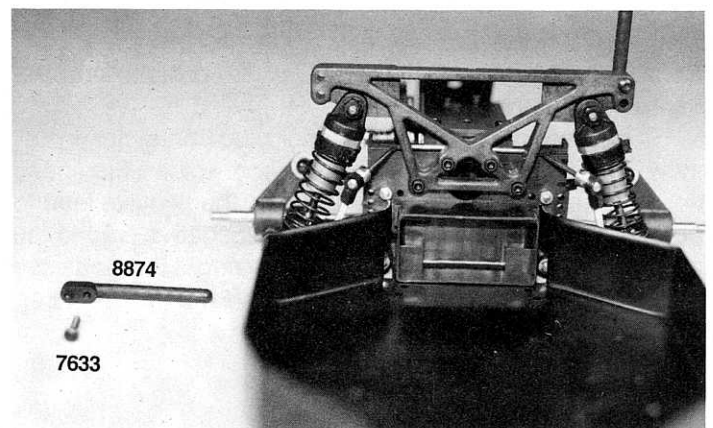

Fig. 114

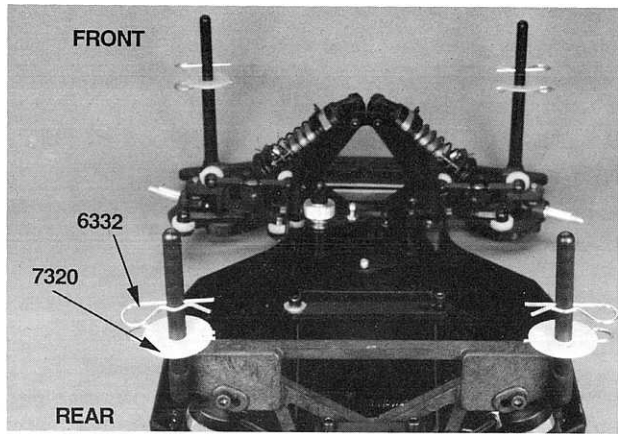

Fig. 115

MOTOR ASSEMBLY AND INSTALLATION

□ **Fig. 116** If you purchased one of our bushing kits you will find a bag containing the motor inside the master kit bag. If you purchased our ball bearing kit you will need to supply your own motor and pinion gear because they do not come with this kit.

CAPACITORS. Depending upon your motor you may need to install capacitors and possibly a Schottky diode (which is only used with electronic speed controls **WITHOUT REVERSE**). Your motor will need a total of three .1uf (micro farad) capacitors (we recommend 50 volt if possible but a minimum of 25 volt) The brand or size does not matter. If your motor already has some capacitors installed, just add the ones you need to bring the total to three. The drawings in fig. 116 show how to install capacitors on both stock and modified motors.

For the bushing kit stock motor the capacitors (three are inside the motor bag) are mounted as follows. One from the motor can to the positive terminal, another goes from the can to the negative terminal and the third goes from the positive terminal to the negative terminal. **Note: Make sure that each lead of a capacitor only touches a lead of another capacitor connected to the same terminal or can grounding point.**

MOTOR PLUG CONNECTOR (for ball bearing kit). In the same motor bag you will find the motor connector plug. Go ahead and solder on the plug red wire to positive and black (or blue on some connectors) wire to negative. **WARNING! You must use ROSIN core solder for making all electrical connections! Do not use acid core solder. We recommend using 60/40 rosin core solder.**

If you are going to use a motor plug connector, install one now. Our Team drivers hard wire (direct solder) the speed control motor leads to the motor. Connect the positive lead to the positive terminal of the motor and the negative lead to the negative terminal. The problem with hard wiring is that you have to have access to a soldering iron to remove the motor for service.

STOCK MOTORS

front rear

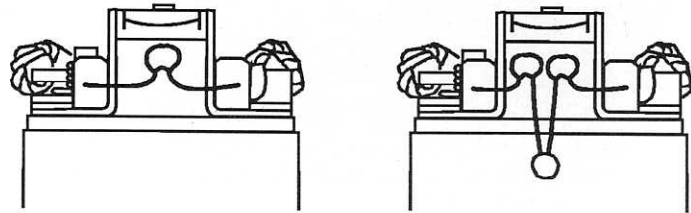

Add three capacitors where shown.

MODIFIED MOTORS

front rear

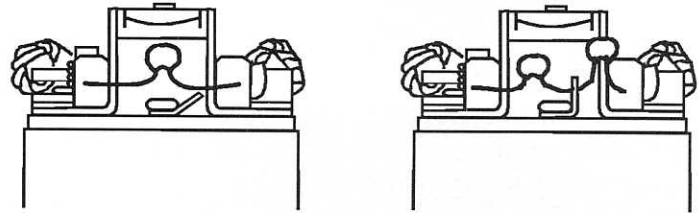

Add three capacitors where shown.

(NOT ACTUAL SIZE.)

Fig. 116

□ **Figs. 117, 118 & 119** 1) If you have a bushing kit you will have a motor bag inside the master kit bag. Open the motor bag and remove the two #6515 3mm x 6mm gold colored socket head cap screws and two #6936 #4 aluminum flat washers. These are the motor mounting screws. You will note that they are metric threads which are different from all other screws in our kit. **Note: If you have a ball bearing kit you will find the two #6515 gold screws and two #6936 washers in a small bag loose inside the kit master bag.**

2) You need to go back to bag #8-15 (for bushing kits only) and remove the #6684 26 tooth 48 pitch pinion gear and #6951 4-40 x 1/8" socket set screw. If you have a ball bearing kit you will need to take out the pinion gear you purchased to go with the motor you purchased.

The following steps will cover the bushing kit motor installation, but all other versions will assemble using the same procedures.

3) Now you can slide the motor into the motor plate opening so that the motor shaft comes out the right side of the motor plate under the spur gear. 4) Now use the #6515 3mm motor mounting screws and #6936 washers to secure the motor to the motor plate (fig. 118).

5) Next we want to install the #6684 pinion gear onto the shaft of the motor so that the set screw will be away from the motor. This means the tooth side of the gear will be going onto the shaft first (fig. 118). Line the pinion gear teeth up with the spur gear teeth and then 6) secure the pinion gear to the motor shaft with the #6951 set screw. Make sure the set screw seats onto the flat portion of the motor output shaft.

7) The last adjustment for your motor will be to set the gear mesh. This is accomplished by moving the motor forward or back so that the pinion gear gets closer or further away from the spur gear. What we want to accomplish is to get the metal pinion gear as close to the spur gear as possible, but without binding the gears. The easiest way to check this is to put your finger on the plastic spur gear and see if you can rock the spur gear teeth back and forth (lightly) between the pinion gear teeth without making the pinion gear move. You want the gears meshed as close as possible, but still have the ability to rock the spur gear. 8) When you have the spacing correct you can tighten down the motor mounting screws. 9) Now recheck the gear mesh to make sure the spacing is still correct. It is important to keep in mind that a tight gear mesh will result in a high power loss, so take your time.

-  #6515 3 mm x 6 mm metric (gold)
-  #6936 #4 flat washer aluminum
-  #6951 set screw

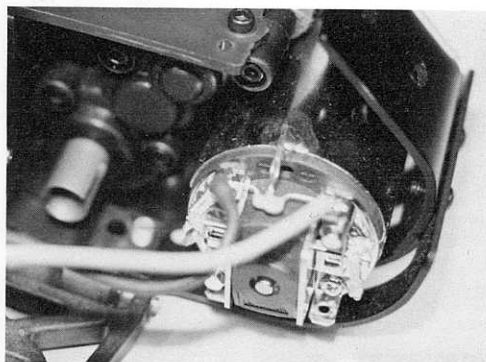

Fig. 117

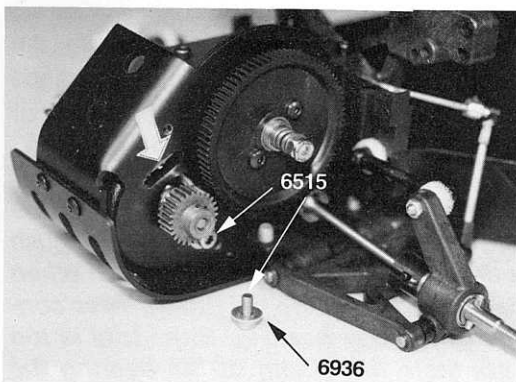

Fig. 118

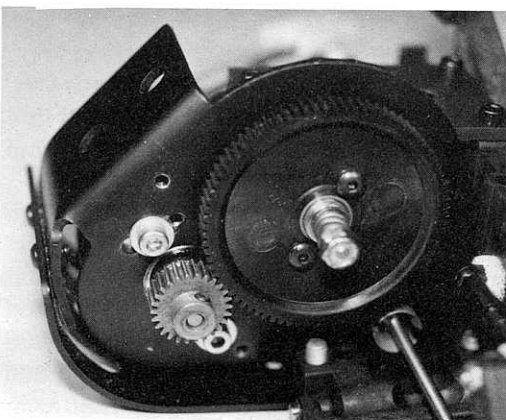

Fig. 119

Fig. 120 Back in the Stealth main bag you will find the bag containing the #6608 plastic gear cover, black plastic insert button, and two #6288 4-40 x 1/4" button head socket screws. Trim the excess from the edge of the gear cover and cut out the hole for the black insert button. You will also want to punch out the holes where the two mounting screws will go. Use the two #6288 screws to secure the gear cover to the motor plate.

Note: When you need to make adjustments to the torque clutch, remove the black insert button, insert a 1/4" nut driver or socket, adjust the nut as necessary and then re-insert the black button. **WARNING!!** If you decide to remove the motor for any reason, you must first remove the dust cover. Do not get the gold colored 3mm motor mounting screws mixed up with the two black 4-40 x 1/4" screws that hold the gear cover on. Mixing these up could cause you to strip out the motor can mounting holes or gear cover mounting holes (in the motor plate). This damage cannot be corrected except by replacing the motor or motor mounting plate.

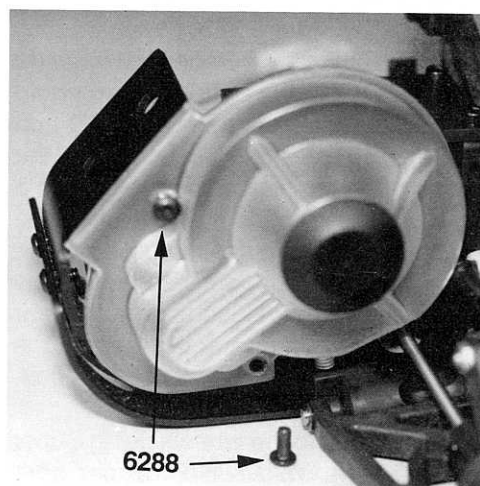

Fig. 120

TIRE AND WHEEL ASSEMBLY

Fig. 121 Remove the tire and foam insert bag from the kit box. In this bag you will find two #8885 front tires, two #8895 rear tires, and four #8889 foam tire inserts. The inserts will be stuck into the center of each tire. Install the foam inserts into the front and rear tires as shown at the left of fig. 121. The foam inserts for the front and rear tires are the same; they will just fit tighter in the front tires. Take your time and do your best to center the foam evenly inside each tire. **Racer's Tip:** To make sure they get consistent results from the tires, Team drivers punch or drill two 3/32" holes in the tire tread or wheel so the tire can ventilate.

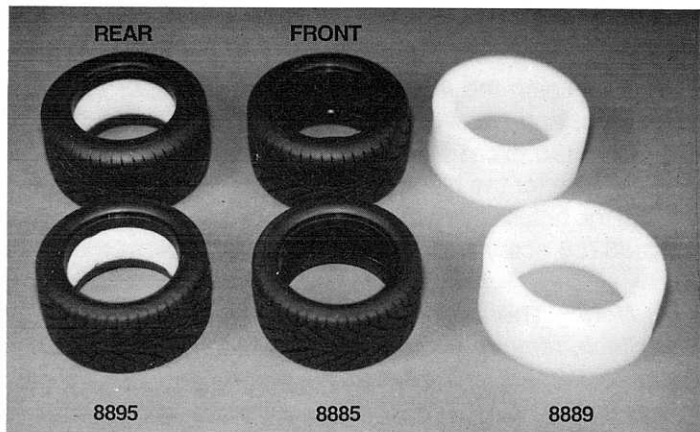

Fig. 121

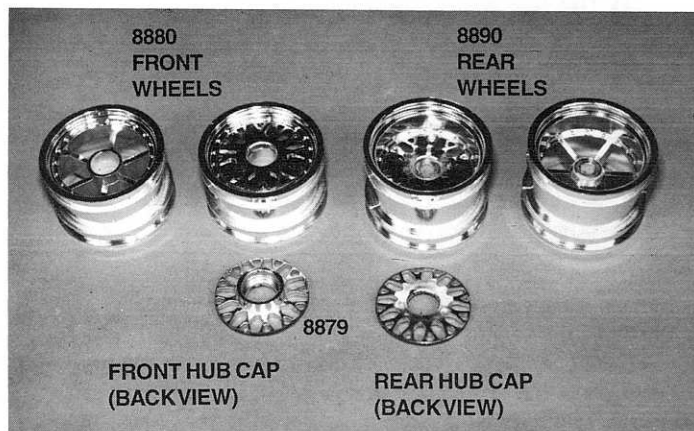

Fig. 122

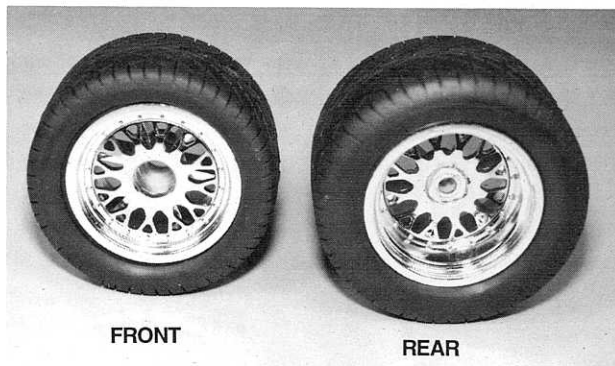

Fig. 123

□ **Figs. 122 & 123** 1) You can now take out the wheel and hubcap bag. In this bag you will find two #8880 chrome metalized front wheels, two #8890 chrome metalized rear wheels and four #8879 gold colored wheel hub cap inserts. The hub caps in your kit will be a BBS style commonly used on many race cars. Fig. 122 shows you two front and two rear wheels. One of each will have the #8879 hub caps installed the other do not so you can see the difference. At the bottom of the photo you will see a back view of one front and one rear #8879 hub caps. 2) Trim off any of the molding gate left in the center of the hub cap before snapping them in place. Install the hub caps into each wheel so that the front of the wheel and hub cap are on the same side. The hub caps are designed to snap into place.

3) Now install the front tires with foam inserts onto the front wheels, and the rear tires with foam inserts onto the rear wheels. Make sure you do your best to center the tires on the wheels so that they will spin true and be as balanced as possible.

4) You need to glue the tires to the wheels using Super Glue (Cyanoacrylic glue) as follows. **WARNING!: Super glue is hazardous. Always wear eye protection and gloves when working with this type of adhesive. Also be sure to follow the glue manufacturer's directions for proper use and safety.** Very carefully push the tire away from the edge of the rim, just enough to create a small gap between the tire and the edge of the rim, and place some Super Glue in the gap so that the glue will bond below the outer edge of the rim. Do this in about five or six places around the tire. Make sure one side is dry before you turn it over and glue the other side. **Racer's Tip:** To make sure they have a round tire Team drivers will place a heavy rubber band around the outer edge of the tire they are gluing to the rim. The rubber band will help to keep the tire concentric all the way around the rim.

□ **Figs. 124, 125 & 126** In the wheel and hub cap bag you will find two smaller bags. One will contain two #6296 8-32 aluminum locknuts and two #6222 black nylon self threading 4-40/5-40 locknuts. The second bag will contain four #6599 3/16" x 3/8" unflanged bronze bushing (**bushing kits**) or four #6906 3/16" x 3/8" unflanged ball bearing (**ball bearing kits**).

Start with the front wheels. Insert one bushing or bearing into each side of the two front wheels. **Note:** Because of the hub cap you may need to use a nut driver or similar tool to push the outer bushing or bearing into its cavity. **WARNING!! When installing the ball bearings make sure the tool you use contacts the outer edge of the ball bearing. If the tool is too small and it only contacts the shield of the bearing the shield will be damaged and the bearing performance can be greatly reduced.**

Now slide one wheel on one of the front axles (hub cap side out) and secure the wheel with the #6222 nylon locknut. Tighten the nut so that almost all of the end play is removed, but not to the point where the wheels and bushings will not free spin. Install the other front wheel and nylon locknut the same way.

Now take one of the back wheels and slide it onto the rear axle. On the back side of the rear wheel you will find a "+" shaped recess. This portion of the wheel is designed to fit over the rear axle roll pin. Locate one of the slots over the roll pin and press the wheel down over it. Now take one of the #6296 8-32 nylon locknuts and thread it onto the rear stub axle and tighten to secure the wheel. Install the other rear wheel and locknut.

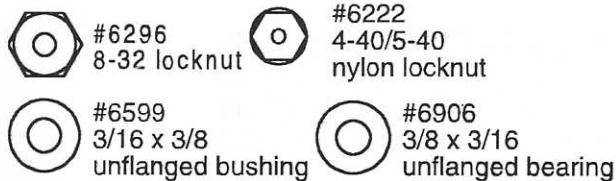

Fig. 124



Fig. 125



Fig. 126

ELECTRICAL ASSEMBLY

We are now ready to install the radio system and electrical components. If you have a bushing kit, part of the electrical components you will be installing is our mechanical speed control which comes in our bushing kits. If you have not picked out your radio system yet now is the time to do so. All Associated cars and trucks are designed to work with most standard radio systems. We do however suggest that you stay with a name brand company like Airtronics, Futaba or JRpropo. Equipment from other companies may fit but we recommend that you

determine this before you purchase the radio system or you will need a written guarantee from the dealer that they will take the radio system back.

Most of the quality radio systems come with medium size servos. Most standard servos use a bushing to support the output shaft of the servo. The torque rating on these servos is around 40 oz./in., which is sufficient for this application. Racer's Tip: for more serious competition we recommend using a medium sized ball bearing servo. All of the popular medium sized ball bearing servos have at least 42 oz./in. of torque which is the absolute minimum torque recommended for competition for a steering servo.

Servo speeds and torque ratings vary greatly as does the price. If you are competing take your time and find the servo that gives you the best torque, speed but will still fit into your budget. Do keep in mind the higher the speed of the servo the more driving skill is required.

STEERING SERVO INSTALLATION

Fig. 127 & 128 1) Open bag #8-6 and remove the #9180 servo horn parts tree. This parts tree contains servo horns designed to fit the three top brands of servos fig. 127. On the surface of the servo horns you will find a molded in "A" for Airtronics servos, a "F" for Futaba servos, and a "J" for JRpropo servos. **Note:** KOpropo servos should use the Airtronics servo horn. 2) Locate and remove the correct servo horn. 3) Go to bag #8-14 and remove one #6270 short ball end and one #6272 foam ball end dust cover. 4) Thread the ball end into the back side of the servo horn so that the ball will be facing the servo when installed. 5) After the ball is installed go ahead and install the #6272 foam dust cover.

6) Remove the stock servo horn that comes on your servo. 7) Now install the #9180 Associated servo horn onto the splined output shaft of your servo. 8) We need to make sure that your servo is laid out with the output shaft to the right side as shown in the photo. **Note:** Check the throw of the servo horn in both directions to be certain that you have near equal travel in both directions. If not, then adjust the mounting of the servo horn by one spline location until this is achieved. When the horn is installed correctly it will be pointing straight up.

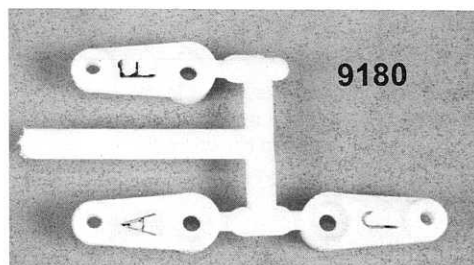

Fig. 127

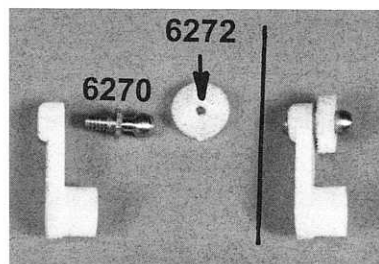

Fig. 128

□ Figs. 129, 129a, 130 & 131 1) Remove the two #6336 nylon servo mounting blocks and two #6292 4-40 x 3/8" flat head socket screws (also in bag #8-6). 2) We are going to mount the servo blocks to the chassis, which will involve some measurements on your part. The mounting hole in the one end of the block is offset so we can adjust the mounting position for different servos. See fig. 129. Measure the servo from the back of the mounting tabs to the end of the servo. If the distance is 1.0" or less, mount the blocks so that the major portion is toward the passenger or right side). 3) If the measurement is greater than 1.0" then mount the blocks so that more of the block is toward the driver's or left side. 4) Next we must drill a hole in each block in the proper place to secure the servo. Now line the blocks up parallel and place the servo between the mounts, making sure the output shaft is towards the rear of the car (fig. 131). Center the servo between the blocks and mark the center of the two **top** mounting holes on the servo using your X-acto© knife.

5) We now know where to drill the blocks. Now remove the servo and mounting blocks. Use a #43 drill bit to drill the two mounting holes. If you do not have access to a #43 drill bit you can use a 3/32" drill bit if you are extremely careful. If you get sloppy when drilling the holes, they will become oversize and not hold the screws when installed. Now that the holes have been drilled we can mount the blocks to the servo.

6) Remove two #6936 #4 aluminum flat washers, and two #6924 4-40 x 3/8" socket head cap screws from the same bag. 7) Place one of the #4 washers on each #6924 screw and use them to install the servo mounting blocks onto the servo as shown in fig. 130. 8) Now reinstall the servo into the chassis using the #6292 flat head screws.

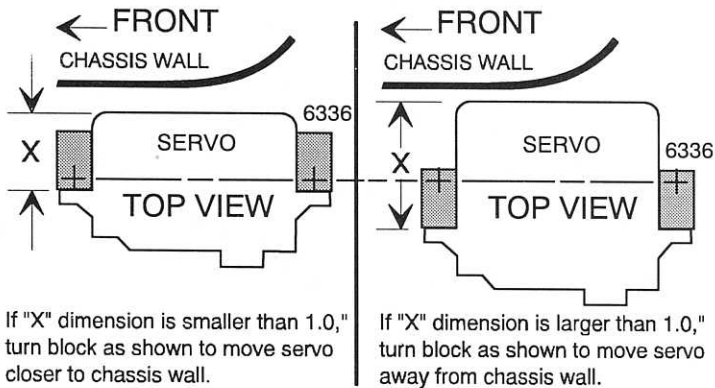

Fig. 129

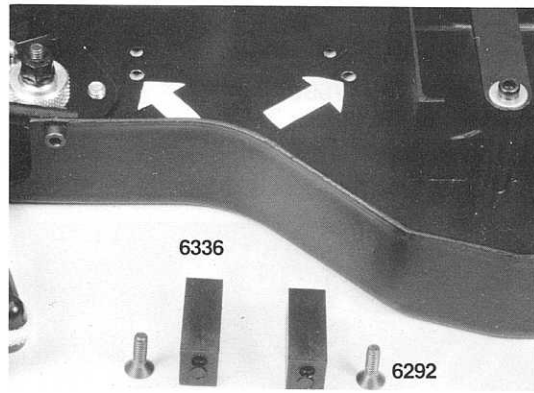

Fig. 129a

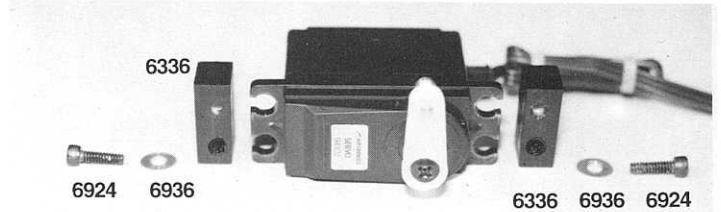

Fig. 130

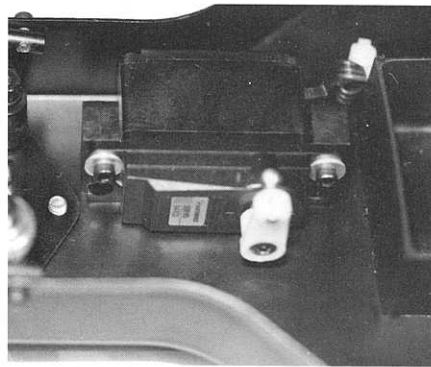
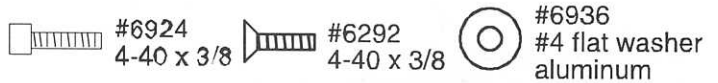
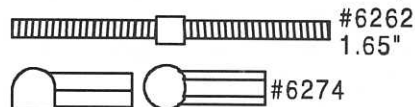

Fig. 131



□ Fig. 132 From bag #8-6 remove the #6262 1.65" turnbuckle. From bag #8-14 remove two #6274 plastic ball end cups. Thread the ball end cups onto the turnbuckle, making sure they are installed evenly. On this turnbuckle one ball end cap will be facing down and the other will be facing to the left.

Because each servo output shaft and case size can be located differently we cannot give you a specific preestablished length for this turnbuckle. To properly adjust the length of this turnbuckle you will want the servo horn to be pointing straight up and the left upper servo saver arm to be pointing across the chassis. When set up this way and all other adjustments are correct both front wheels should be pointing straight (parallel with the centerline of the chassis).



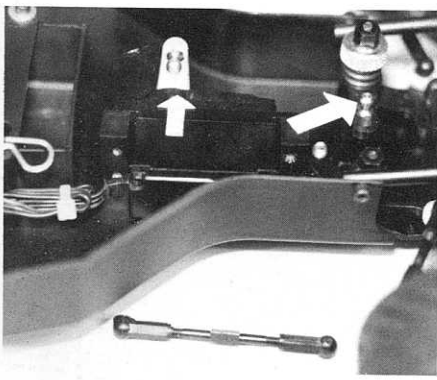

Fig. 132

MECHANICAL SPEED CONTROL INSTALLATION

The following assembly only applies to the BUSHING KITS. If you have a BALL BEARING KIT you will NOT have a bag #8-13 and you can then skip forward in the manual to fig. 146.

In your bushing kit you will find bag #8-13 which contains the parts to assemble our mechanical throttle control. This is a race legal resistor style throttle control which has a nine step forward and five step brake circuit. **THIS RESISTOR DOES NOT HAVE REVERSE.** The following steps show you how to install and adjust the mechanical speed control using our new mount and bracket system. **Note:** The new throttle servo mounts will only fit a medium size servo (this is what is standard with most radios).

Remember if you have purchased a ball bearing kit there will be no bag #8-13 in your kit box. For those of you who will be using an electronic speed control we will have a couple of reference photos at the end of this section.

□ **Fig. 133** Open bag #8-13 and remove the two #7527 throttle servo mounts, four #6932 4-40 x 5/16" socket head cap screws, and four #6936 #4 aluminum flat washers. Orient your servo and arrange the servo mount as in fig. 133. Now secure the servo mounts to the servo using the #6932 screws and #6936 washers (fig. 133).

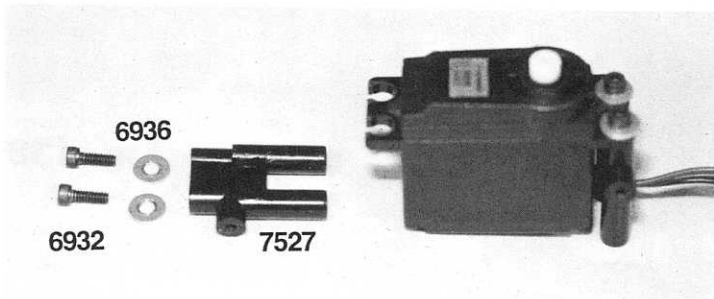

□ #6932 4-40 x 5/16
 ○ #6936 #4 flat washer aluminum **Fig. 133**

□ **Figs. 134, 135 & 136** 1) From the same bag remove the two #8850 black aluminum throttle resistor brackets, the #6711 green throttle resistor, two #6932 4-40 x 5/16" socket head caps screws, and two #6936 #4 aluminum flat washers. 2) There is a left and right resistor mount. We will start with the left mount as shown in fig. 134. Use one of the #6932 screws and #6936 washers to secure the bracket to the left side throttle servo mount. Make sure the bracket bends away from the servo. We still want the top to be flat and paralleled with the ground. 3) Now we need to pick up the #6711 throttle resistor. We are going to slide the resistor onto the left bracket at the top. Fig. 136. Make sure the solder tabs on the resistor are facing towards you (away from the servo). 4) Now pick up the right side bracket and slide it through the right side of the resistor. Line up the slot in the bracket with the hole on the right side mount. 5) Use the remaining #6932 screw and #6936 washer to secure the bracket to the mount. **Note:** The brackets have vertical slots in them that will allow us to adjust the height of the resistor to make sure we have good electrical contact between the resistor and wiper arm with different servos.

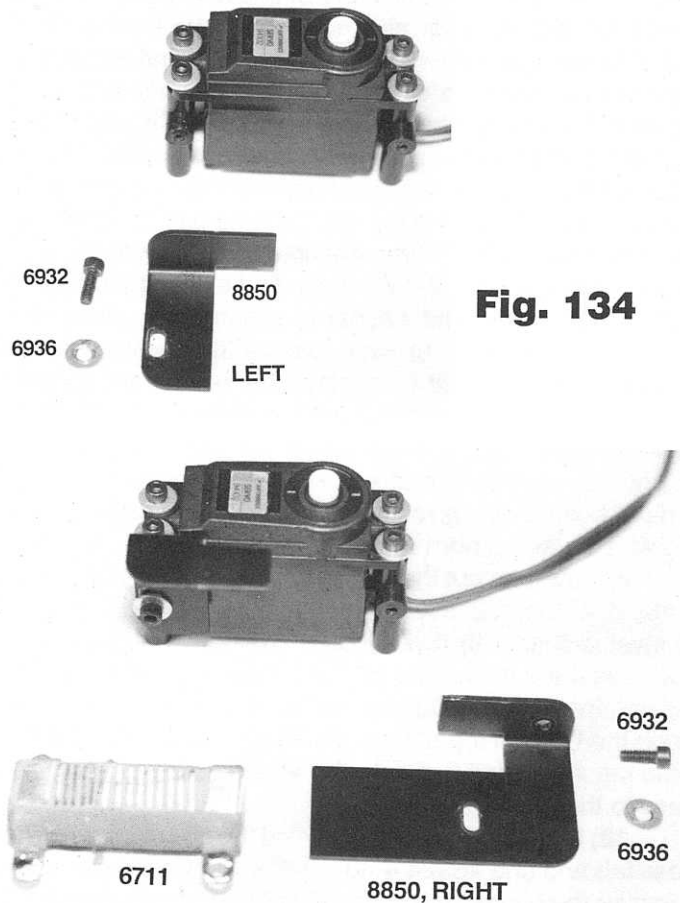

Fig. 134

Fig. 135

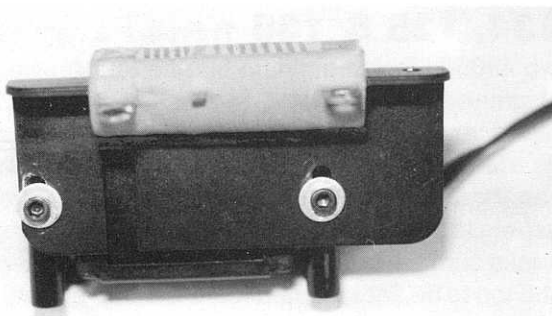

Fig. 136

- #3721 2-56 self tapping
- #6295 4-40 locknut
- #6924 4-40 x 3/8
- #6925 4-40 x 1/2

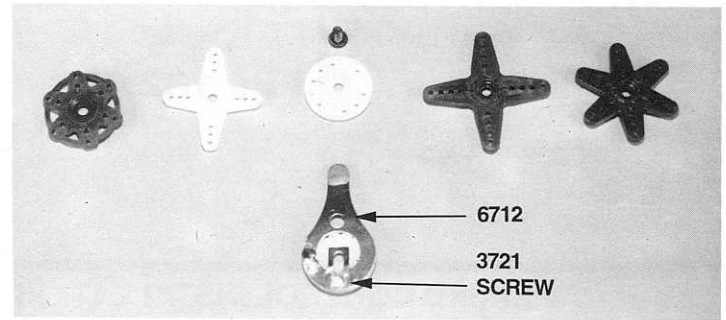

Fig. 137

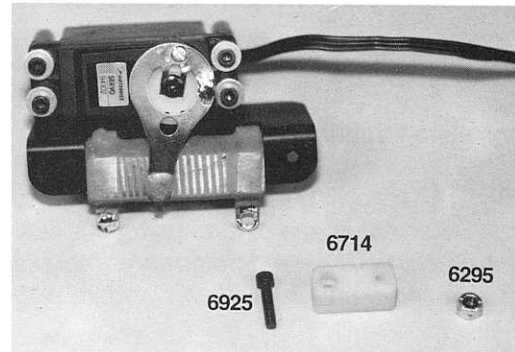

Fig. 138

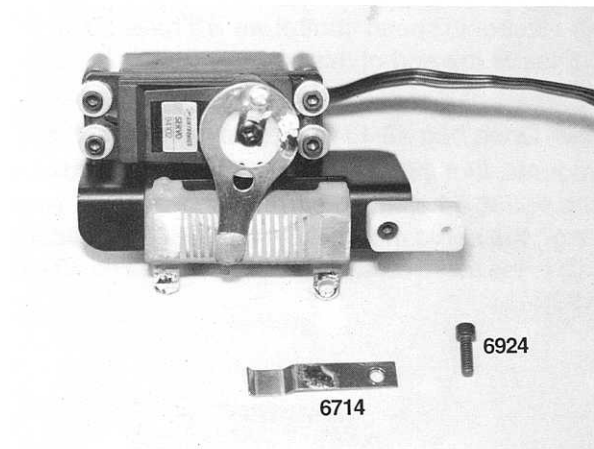

Fig. 139

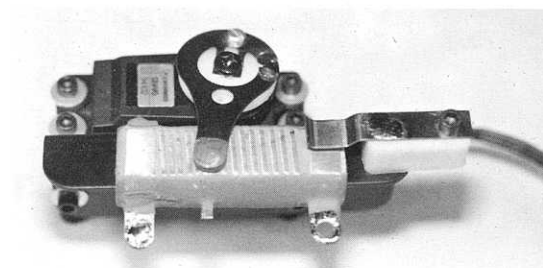

Fig. 140

Fig. 137, 138, 139 & 140 1) Still using bag #8-13 we now need to remove the #6712 throttle wiper arm, one #3721 #2 sheet metal screw (there should be two in the bag), and one #3721 #2 flat washer.

2) We now want to take out the servo you are going to use for your throttle. Fig. 137 shows five types of servo horn designs. The ideal design for this application is the small round servo horn shown in the center of the photo. While the other servo horn designs will work, they will require trimming so that they do not interfere with the wiper arm movement. 3) Mount the servo horn back onto the servo but do not install the screw. 4) Place the #6712 wiper arm over the servo horn (with the button side facing down). 5) The servo screw that secures the servo horn to the servo goes through the center hole of the wiper arm. Install this screw but do not tighten it yet. 6) Now look at the bottom of the wiper arm (the round area). You will see a small hole. Rotate the wiper arm until you can find a hole in the servo horn that lines up with the hole on the edge of the wiper. You have a little movement up and down with the wiper to help in finding a hole. 7) When you find a hole go ahead and use the #3721 screw and washer to secure the bottom of the wiper to the servo horn. 8) Now remove the servo screw and the servo horn. We want to reinstall the servo horn so that it lines up over the wide neutral band on the throttle resistor. The output shaft of the servo is splined so you can rotate the servo horn one spline at a time to adjust its starting position. Once you have it lined up correctly, go ahead and secure it to the servo with the servo horn screw.

9) Now take out the #6714 yellow nylon bypass mount, one #6925 4-40 x 1/2" socket head cap screw, and one #6295 4-40 steel locknut. 10) If you look at the #6714 bypass mount you will see there are two holes. On one side one of the holes is recessed. Install the #6925 screw into the recessed hole then through the hole on top of the right #8850 resistor bracket. 11) Thread the #6295 locknut onto the #6925 screw to secure the bypass to the right bracket.

12) In the same bag you will find the #6714 brass throttle bypass tab and one #6924 4-40 x 3/8" socket head cap screw. 13) Secure the bypass tab to the #6714 mount using the #6924 screw, making sure the bent portion of the tab is over the resistor. The #6712 wiper arm button is designed to fit snugly between the resistor and the #6714 bypass in order to make a better electrical connection. Your assembled throttle servo and resistor will look like fig. 140.

□ **Figs. 141 & 142** Remove two #6292 4-40 x 3/8" flat head socket screws from bag #8-13. We will use these to secure the throttle resistor servo to the chassis. There are several holes running along the left or drivers side of the chassis. If you look at the bottom of the chassis on that side you will see three holes that have been countersunk. We will be using the back two countersunk holes. Place the throttle servo assembly into the chassis with the resistor facing the battery area. While there are four mounting holes on the servo mounts we will only be using two. Line up the inner mounting holes with the matching countersunk chassis holes and secure the mounts using the two #6292 screws.

 #6292
4-40 x 3/8

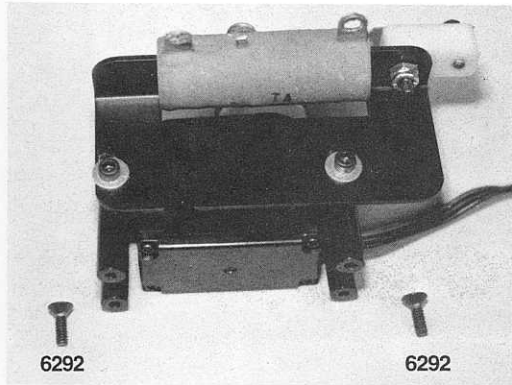

Fig. 141

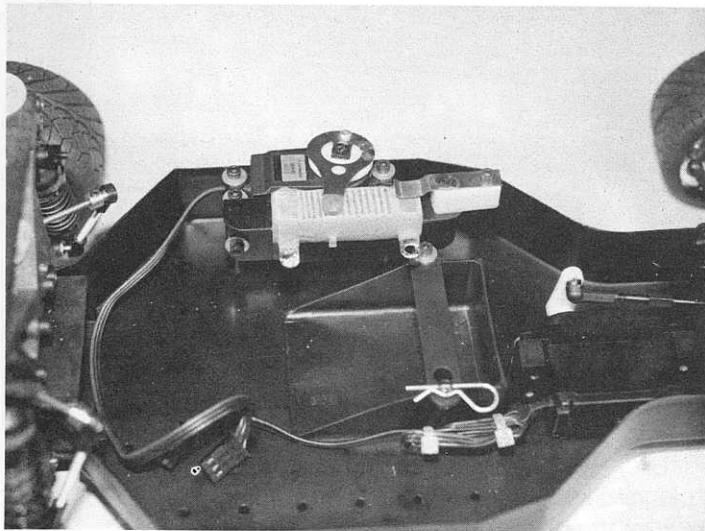

Fig. 142

□ **Figs. 143, 144 & 145** 1) Now we can begin to solder the wiring for the throttle resistor. In bag #8-13 you will find a small 2 inch piece of red 16 gauge wire. 2) Solder one end of this wire to the #6714 brass bypass tab and the other to the positive tab on the throttle resistor (at the front of the car) as shown. You can shorten the wire to make the installation look better.

3) Next remove the #6747 battery input power harness (with B.E.C. plug). Fig. 143 shows this harness laid out in front of the chassis. Fig. 144 shows it installed. Solder the large red

wire to the positive tab on the throttle resistor and the large black wire to the negative tab on the same resistor.

4) The last wire we need to take out is the #6745 motor output plug which is shown at the bottom of fig 144. We will solder the red wire to the #6714 wiper arm and the black wire to the negative tab on the resistor. Fig. 145 shows this plug harness installed. 5) After you have soldered the #6745 onto the wiper arm and resistor you can then plug it into the motor plug. Your throttle resistor is now installed. We will check out and make any adjustments in the final adjustments later in the manual.

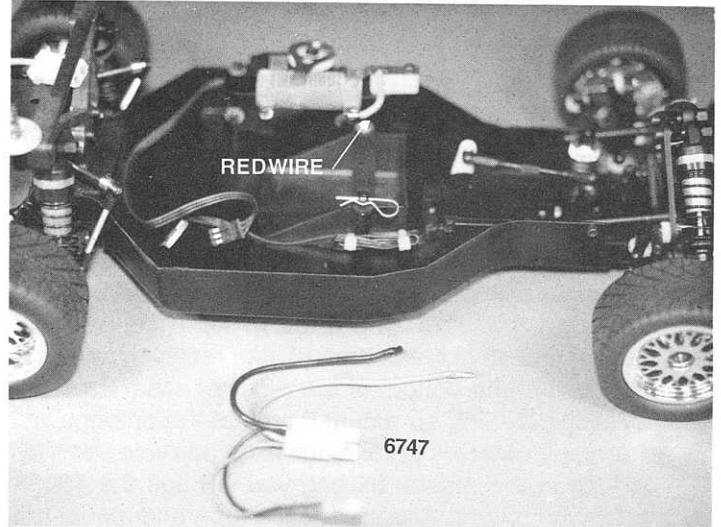

Fig. 143

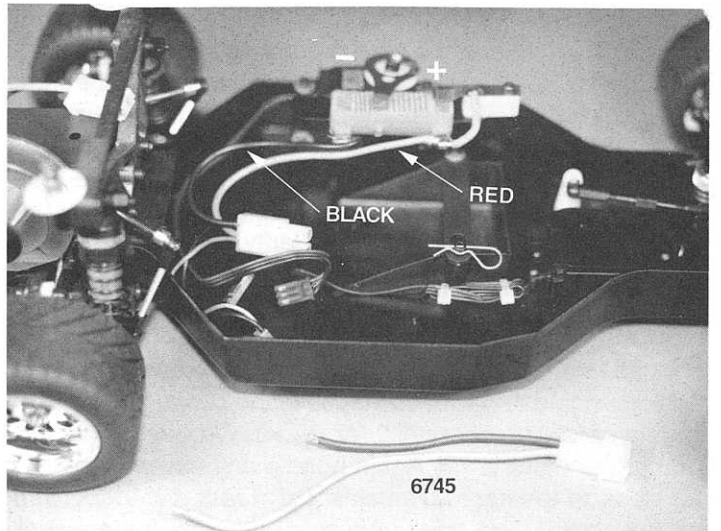

Fig. 144

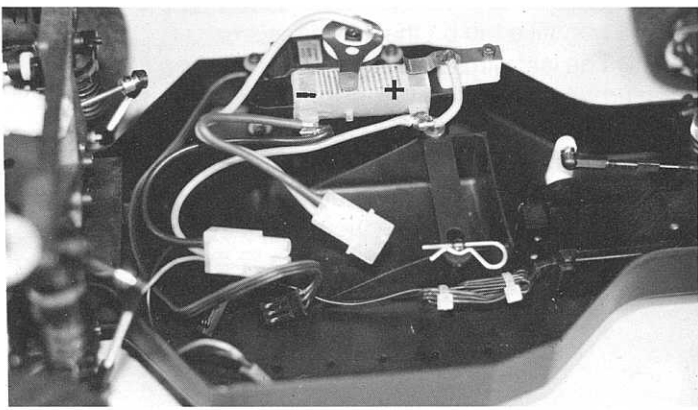

Fig. 145

#6922
4-40 x 1/2

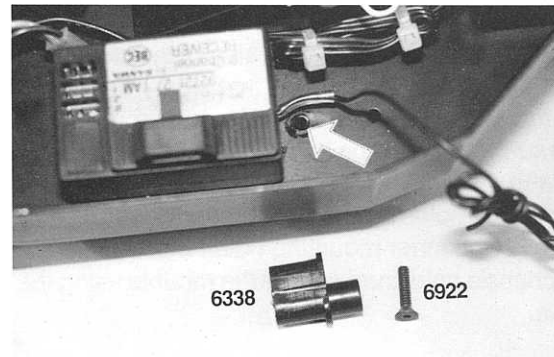

Fig. 146

□ **Figs. 146, 147 & 148** 1) We are now ready to install the radio receiver. We want to install the receiver on the right or passenger side of the chassis. In the master kit bag you will find a small 1 1/2" x 6" strip of servo tape (double stick tape). 2) Cut a piece to fit the bottom of your receiver, peel one side, and apply it to the bottom of the receiver case. Each receiver is slightly different, so mount it so that the antenna will be away from any other wires as much as is possible.

3) Also in the master kit bag you will find the #6338 antenna tube with mount. Attached to the tube and mount will be a #6922 4-40 x 1/2" flat head socket screw. Before you fasten the mount, run the antenna wire up through the mount. 4) Use the #6922 screw to fasten the mount to the chassis. There is a counter sunk hole to the front or back of the receiver location that can be used. In these photos we have used the front mounting hole. 5) Now measure the amount of antenna wire exposed above the mount and cut the tube so that it is about 1" shorter. 6) Run the wire through the tube and insert the tube into the mount. We have not installed the tube for most of the remaining photos to improve picture clarity.

7) The final step will be to plug in the servo wires and on/off switch harness. We will start with the steering servo wire. On the receiver you will find various markings. The steering servo plugs into channel 1 (or thro). 8) Any excess servo wire should be bundled and wire tied close to the servo. 9) Now plug the throttle servo into channel 2 (or Rudd). We want to run this wire under the battery. 10) Again bundle any excess wire and keep it close to the servo. **Racer's Tip:** Team drivers place a piece of electrical tape on the chassis under the battery pack where the throttle servo wire will go. They then apply another piece of electrical tape to hold the servo wire in place. This protects the wire from any chafing that could be caused by the battery pack.

11) Your radio should come with a on/off switch harness. On this harness one end is designed to plug into the B.E.C. connector on the #6747 battery input harness, and 12) the other end will look like the B.E.C. connector and will plug into the receiver battery slot (or Bat). **Note:** In fig. 148 we have bypassed the on/off switch harness and plugged the B.E.C. connector directly into the receiver. If you choose to do this, remember, you will need to unplug the connector each time you want to turn the car off or plug it in before you want to run the car.

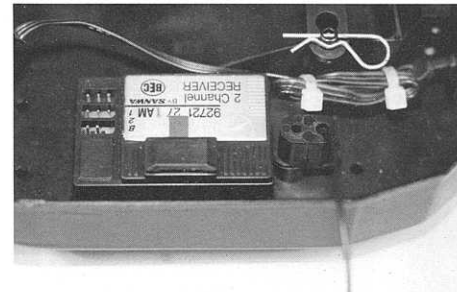

Fig. 147

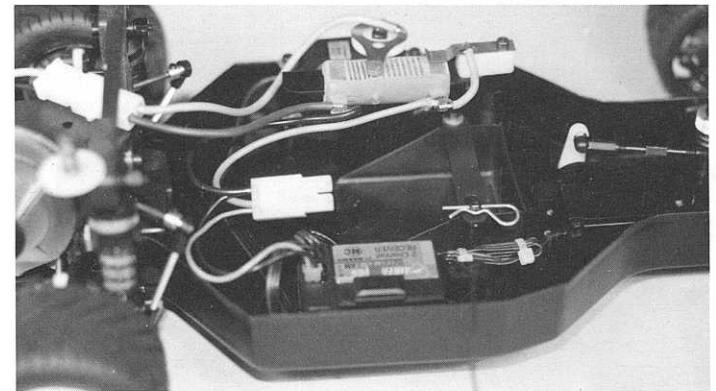

Fig. 148

□ **Fig. 149** This photo shows the battery pack installed and plugged into the #6747 battery input harness. **WARNING! Make sure the on/off switch is in the off position or the B.E.C. connector is unplugged before plugging in the battery pack.**

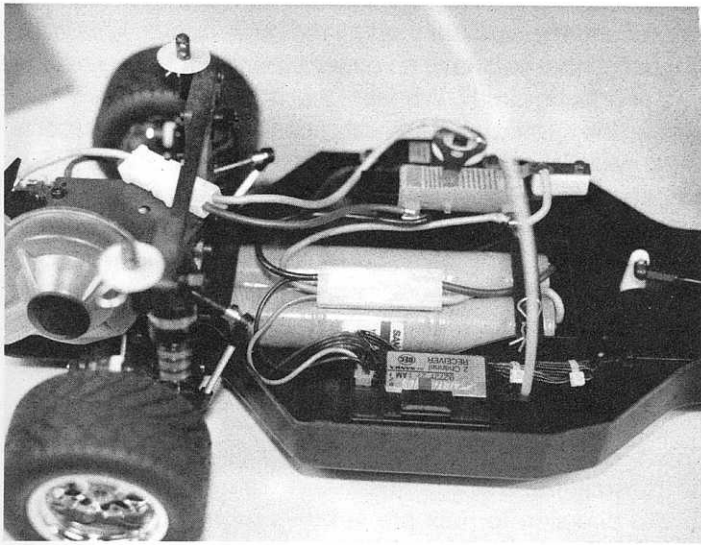

Fig. 149

ELECTRONIC SPEED CONTROL INSTALLATION

The following photo shows the basic layout of an aftermarket electronic speed control (commonly called an ESC) in your bushing kit. This is for the ball bearing kits or a bushing kit wanting to upgrade. The following photo and drawing are intended to give you some basic recommended layout and wiring information. For more detailed information on installing or adjusting your ESC refer to your ESC manual.

Fig. 150 & 151 Fig. 150 shows an LRP electronic speed control installed and wired in the chassis. In these photos we are showing hard wiring connections and a matched battery pack. The motor and battery wire connectors shown in the previous photos accomplish the same function as the connections shown in fig. 150, but with the added convenience of being able to be unplugged. **Note:** The LRP ESC is a three wire speed control. This means that the same red wire that connects to the battery will also be connected to the motor positive terminal. The black wire is for battery negative only and the blue wire is for motor negative only.

Fig. 151 is a basic drawing schematic of the wiring connections between the motor, ESC speed control, and battery pack.

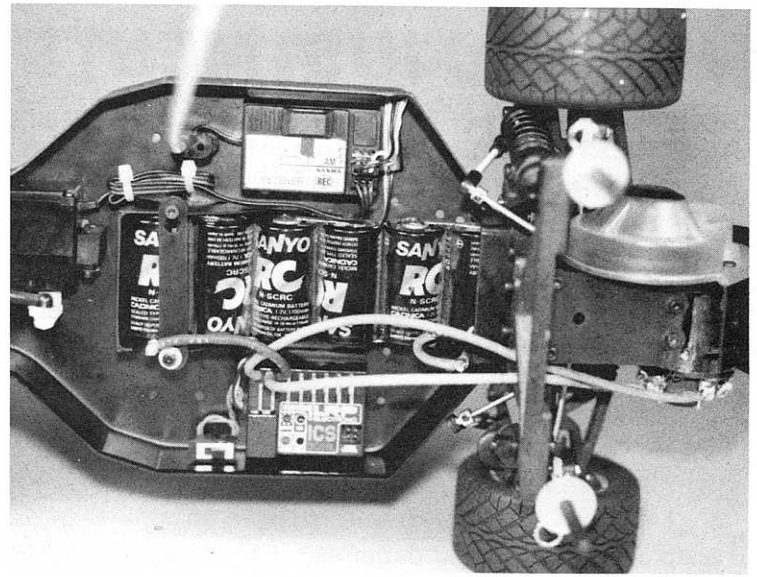

Fig. 150

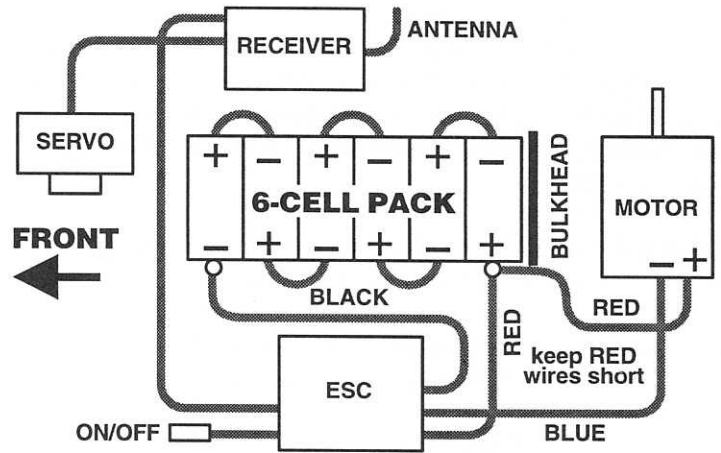

Fig. 151

Fig. 152 This is a photo of your completed car before the installing the body.

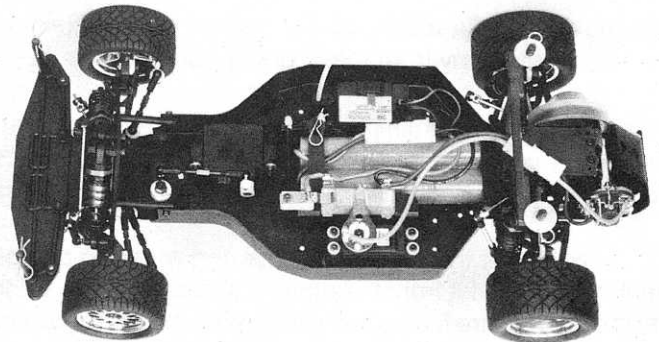

Fig. 152

FINAL ADJUSTMENTS

BATTERY CHARGING. Charge your transmitter batteries if they are Ni-Cads. This will require an overnight charge. Next charge your battery pack according to your charger manufacturer's recommendations. Make sure all the speed control connections are according to the kit manual or the speed control manufacturer's specifications. Then go on to the steps following in the order listed.

- Step 1** Turn the transmitter switch ON.
- Step 2** Make sure the motor is UNPLUGGED.
- Step 3** Plug in your car batteries.
- Step 4** Turn the car switch ON (normally this will be the radio on/off switch or the speed control on/off switch).
- Step 5** Turn the steering wheel to the right. See if the front wheels also turn to the right. If they turn to the left, you will have to move the steering servo reversing switch to the other position. Follow your radio system instructions on how to do this. Recheck to make sure both the radio and front wheels turn to the right.
- Step 6** When your wheels turn the correct way, take your hands off the steering wheel. Is the servo arm, on the steering servo, centered or in the straight up position? If it is off just a little bit you can adjust it using your steering trim knob on the transmitter. If it is off quite a bit you will need to remove the servo horn from the servo and center it so it is in the straight up position. Fine tune with your radio trim knob if necessary.
- Step 7** Are your wheels now pointed straight ahead? If not, start by checking the upper left servo saver arm. Does it point straight across the chassis? You can correct any problems by adjusting the turnbuckle that connects between the servo saver and servo horn on the servo. If you have corrected this problem and your wheels are still not pointing straight ahead you will need to adjust the steering tie-rods to line up the front wheels. Remember, we do not want any front toe-in or toe-out to start with.
- Step 8** Leave your transmitter and car switch on. Now check the manual on your transmitter to find out if you have a 70/30 setting or switch. If you do, you will need to move it do this setting now.

Now look at the throttle resistor and wiper on on your throttle servo (look at it from the driver's side so that the solder tabs on the resistor are facing away from you). Now squeeze the trigger on the transmitter. Does it go to the left and under the bypass tab on the left side of the resistor? If it goes to the right then you will need to move the throttle reversing switch to the opposite position.

Just to the right of center on the face of the resistor you will see a band that is wider than all the other bands. This is the neutral bar so that you have no current being used by either the forward or braking circuit. We want the wiper arm to rest on this band when the throttle is in its neutral position. If your wiper is only off a little you can use your throttle trim to move the wiper to the right location. If the wiper is too far away to be adjusted by the throttle servo trim, you will need to remove the servo horn screw and then the servo horn so you can adjust the mounting position by one spline and then remount. Keep doing this until you achieve your required location. Fine tune with the throttle trim on your transmitter. Now recheck to make sure that the throttle wiper arm still goes to the left and under the throttle bypass tab.

Push the trigger forward and make sure that the wiper arm does not drop off the resistor when full brake is applied. Some transmitters have an adjustment to limit maximum travel in the brake direction to help prevent this problem. Check your manual. **Note: If you have a radio system that does not have a 70/30 setting or switch but only the older 50/50 setting you can still make it work. It just requires a little more time and effort. For this system you will have to have the wiper arm to the left of the neutral band and use the throttle trim to bring it back over the neutral band. You will have to use almost all of the trim adjustment to accomplish this so that the wiper arm should not drop off the resistor when full brake is applied.**

If you have an ESC, then follow its instruction manual to make all necessary adjustments and settings.

Now turn the car switch OFF. You can now plug your motor back into the motor power lead from the throttle resistor or your ESC speed control.

- Step 9** A word of caution here. Have the car sitting up on a block or car stand so the rear wheels cannot touch anything before you turn the car switch back on to check the speed control and motor operation. Recheck the speed control settings with the motor now connected.
- Step 10** When you are done setting the speed control (and probably playing with the throttle) turn the car switch OFF.
- Step 11** *The transmitter switch must always be the **FIRST SWITCH TURNED ON** and **THE LAST SWITCH TURNED OFF**.*

YOUR CAR IS NOW READY TO RUN!

PAINTING THE BODY & SPOILER OR WING

Because we offer two kits with different style bodies we are only going to show a basic body showing the wheel well cutouts and any other basic generic information in the following photos. We assume you will be able to handle any differences between the body you received in your kit and the body shown in the photos.

TRIMMING THE BODY. The body can be painted before you cut out its holes; however, it's easier to install the

body while it is still clear, because it will be easier to locate and cut the holes for the body mounts and antenna tube. Trim a little off at a time until the holes clear. Cut out the body mounting holes. **Racer's Tip:** Mark the areas with a marking pen that you want to trim, then use an X-acto® knife with a new blade to score the lines you just marked. You can then flex the body at the score line and peel off the part you want to remove. Be very careful around any sharp corners to prevent the body from tearing where it is not supposed to.

MASKING THE BODY. Make certain that the body is thoroughly clean. You can wash it with regular soap and water. Because you will paint the inside of the body, you will mask the inside. Now mask the body off according to your paint scheme. Use automotive masking tape for the best results. Take the time to press all edges of the tape down with a Popsicle stick or your fingernail. To prevent overspray from getting on the outside of the body, put masking tape on the outside of the body at the body mount and antenna tube holes. When painting, you should apply the darkest colors first and the lightest last. This prevents the darker color from "ghosting" through the lighter color. So first mask the section to be painted white. The next color you mask is the next darker color nearest white, and so on.

PAINTING THE BODY. Now that you have the body fitted, it is time to paint it. The body is made of Lexan polycarbonate and is painted on the inside. There are two different ways to paint the body, by either brushing it on or spraying it on. You can find special Lexan or polycarbonate paints made to be brushed onto the body. Brushing the paint will always leave streaks in the paint job but will look satisfactory from a distance. If you want to spray the body, one of the best brands of spray paints, for Lexan bodies, is *Pactra R/C Car Racing Finish*, available in most hobby shops.

Apply the paint in very thin coats, letting the paint dry between coats. **WARNING!** If the paint is sprayed on in heavy coats, the thinner in the paint will liquid and attack the Lexan, then the body becomes brittle and will crack easily.

Spray your darkest color first. Then peel off the next layer of masking tape and paint the next lighter color, and so on. If you make a mistake, the only product that we have found that can remove the paint without damaging the Lexan is Synthetic Reducer, which can be purchased through a automotive paint supply store.

MOUNTING THE BODY

In order to get the correct body height you will need to know where to start with positioning the body pins and washers. The locations for the two bodies that come with the kits are as follows:

Trans Am Mustang Cobra:

FRONT: Starting from the bottom of the mount place the first two #6332 front body pins in the second hole from the bottom. Next install the #7320 nylon body washers, and these will be followed by the second two #6332 body pins after the body is installed.

REAR: The first rear #6332 body pin will go into the very bottom hole on the rear mounts. This will be followed by the #7320 nylon body washers and the second two #6332 body pins after the body is installed.

The Mustang body comes with a rear spoiler. We have

supplied a second 1.5" x 6" strip of servo tape to cut into two strips and secure the spoiler to the body.

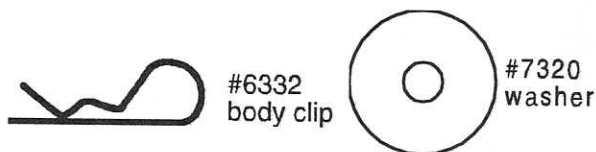

DS MAINTENANCE

You will find your RC10DS will give you many hours of trouble-free operation. Even so, you should periodically check all moving parts: front and rear A-arms, steering blocks, hinge pins, steering linkage, shocks, and so on. You should also check all screws occasionally for tightness. Binding in any of these parts due to dust or dirt will deteriorate the car's handling and performance. It will also increase wear on all moving parts. Just like a real car, frequent maintenance will help prevent premature failure of an important part. The following information covers other areas that require maintenance or problem solving.

MOTOR TROUBLESHOOTING. Because this car is designed to run on streets or parking lots you will be exposed to a fair amount of dust and dirt. It is possible for the dirt to prevent the motor from working correctly. This means that if you are having problems with your motor not working, then there are things you should check first.

1) If the motor does not run at all you should check the wiring connections first. Are all wires and capacitors connected properly and are all the solder connections in good shape? A bad solder connection will have a dull finish or it will be rounded under at the edges (which means the solder did not flow to bond to the connection material. Pull on the wires to make sure that the connections are really solid. The second cause could be a sticking or hung up brush. **2)** A sticking brush would be caused by dirt and a hung brush would be caused by a brush wire getting caught on the brush holder. Both of these can prevent the brush from being able to slide in and out so that it can make contact with the commutator. Either one can be corrected by pulling the brush out a very small distance and then letting it snap back into the brush holder by the spring pressure. For dirt, cleaning the brushes will correct this. To prevent a future hang up on the brush wire it should be routed over the top of the brush holder and then down and into the spring slot on the side of the holder. This way the wire can follow the spring and cannot get caught or bent over the outer edge of the holder. Always keep in mind that the brushes need to be able to move freely in the brush holder.

3) To check for a possible shorted motor you will want to remove the motor pinion from the motor so that the vehicle cannot get away from you or cause any damage. With a fully charged battery pack, turn on the radio transmitter, then the car. Now give the car full throttle. Does the motor seem to reach full speed? If you are using a high revolution motor, it should sound like it is turning at a very high speed. Next, with the motor still running, place one finger on each side of the motor end bell so that one finger is contacting positive and the other is contacting negative. We are not trying to make electrical contact, we are just going to

be looking for excessive heat. If the motor is shorted it will get hot enough on one or both sides of the end bell within less than a minute. This means it will become hot enough that it will burn your fingers if the motor is still running at the end of the minute. If this is the case, then you would need to send us the motor along with a copy of the purchase receipt that shows the date of purchase so that we can inspect the motor for defects, confirm your problem, and then send you a motor at no charge. For your own time consideration, please check the motor, car and wiring to make sure that there is nothing else causing your problem before sending in a motor. This will help to prevent your losing unnecessary time in being able to enjoy your new car kit.

Never overgear your car (large pinion and/or small spur gear). Overgearing your car can cause excessive heat and can damage or destroy your motor.

MOTOR MAINTENANCE. After a few runs you should carefully clean the motor. One recommended method is to connect the motor to an old battery pack or one that is almost fully discharged. We just want to run the motor at a fairly low rpm. While the motor is running, spray a motor cleaner directly on the brush commutator area. Run the motor for approximately 15 seconds and apply the spray several times for 2 to 3 seconds. Now disconnect the motor and spray the motor one more time, making sure the runoff is clear and clean. If the runoff is still dirty repeat the above steps until clean. After completing the cleaning, apply a small amount of light weight oil to the bushings or ball bearings (at each end of the motor shaft) for lubrication.

BRUSH MAINTENANCE. After no more than every 3 to 5 runs, remove the brushes from their holders and inspect the tips for wear and/or burning. If you notice any wear, replace the brushes with a new pair. You can determine this by looking directly down at the top of the brush hood. If the top end of the brush spring is directly over the lower end of the brush spring (parallel) the brush has worn to its limit and needs to be replaced. To inspect for a burnt tip, look at the side of the brush on the contact end. If it is a burnt blue color, new brushes should be installed. These are important steps, because worn or burnt brushes can cause and/or increase the amount of damage or wear to the motor commutator. Changing brushes frequently will help maintain the life of your motor. For stock motors (standard upright brush only) we recommend our #738 Reedy motor brush; for modified (standard upright brush) motors we recommend our #737 Reedy motor brush. For the modified (large commutator laydown brush) we recommend our #760 Reedy motor brush. These are off road compounds that give you excellent motor commutator life and good power, but we do have other compounds for different applications.

SCHOTTKY DIODE. A new development for motors and high frequency electronic speed controls (ESC's) is an add-on device called a Schottky diode. This diode is used by many ESC and motor manufacturers to improve the life and performance of both components. The diode is supposed to keep the braking MOSFET's cooler, improving their performance and making them more consistent. It also helps to reduce the amount of high voltage spikes from the motor that could reach your ESC. These spikes can contribute to premature failure of the ESC. The reduced spikes also would increase the motor commutator life. Reedy sells a package of two replacement diodes, #745. **WARNING!! Do not use Schottky diodes with reverse ESC's, or the speed control will be damaged! Also, the diodes are polarized,**

so make sure that you hook the positive to positive and negative to negative. If connected backwards, the car will act like it has a shorted motor when the throttle is applied until the diode shorts out. We also recommend the use of two diodes per motor when running a high current, low wind motor in a car or truck. Because of the high current a low wind motor can draw coming off of a corner due to high traction, it is possible to overload a single diode.

A full line of recommended Reedy DS stock and modified motors are listed in your included DS catalog, which should be packaged with your kit. If you did not receive one you can call or write us asking for the DS catalog, and we will be happy to send you one at no charge.

RADIO SYSTEM PROBLEMS. A radio problem can be caused by several different events or just one single event. The most common problems tend to be a combination of at least two different problems. The areas that can contribute or cause a problem are: motor noise, poor electrical connections, bad wiring layout, reversed or defective radio crystals, weak transmitter batteries or other causes. If your radio problem persists, one of the following tips may be of help.

Make sure your motor noise capacitors are properly installed and working correctly. Most ESC manufacturers now recommend three per motor.

Make sure the brushes are free in their brush holders and that they are not chipped, which could cause arcing. Replace if necessary.

Try a different motor.

Try a different radio frequency.

Try mounting the receiver on its side with the crystal up to get it away from the chassis. Also move it away from the side of the chassis. Try moving the receiver up to the rear shock strut and mount the antenna on the rear bulkhead or shock strut.

Route the radio wires (servo connector wires) well away from the power leads to the motor or battery. Also place electrical tape under any servo wire where it lays across the chassis.

Move the antenna wire away from the servo wires which can generate a signal into the antenna wire.

Most ESC's are now of a high frequency design. This means that they also have the ability to generate a signal which can cause interference with the receiver. Try to keep them at least two inches apart if possible.

If you are using a Schottky diode on your motor make sure that it is soldered on correctly. If soldered backwards it can make the car feel like the motor is shorted or even have limited radio range.

Keep in mind that you can also run into outside interference at times, and the 75 Mhz band will tend to be more susceptible to the problem than the 27Mhz band. Large metal objects such as chain link fences, lamp poles, cars, vans, trailers or even fluorescent lights can occasionally cause local interference by blocking or reflecting a signal.

DIFFERENTIAL MAINTENANCE. You should rebuild the differential when the action gets somewhat gritty feeling. Usually cleaning and applying new lube per instructions will bring it back to new condition. The tungsten carbide diff balls (which are standard parts) should rarely need changing if everything is properly adjusted. **Note:** *Allowing the differential to slip (adjustment outside the specified range) will cause the carbide balls to skid on the drive rings and this will cause the balls to flat spot,*

and they will then need to be replaced to keep the diff rolling smoothly. Normally, as the parts seat in, the diff will feel smoother. If after carefully cleaning and relubing the diff parts the diff still feels gritty, the thrust balls, thrust washers and drive rings should be checked and possibly replaced. The parts will normally wear and need to be replaced in the following order: #6574 5/64" diff thrust balls, #6573 diff thrust washers, the #6579 diff drive rings, and then after many rebuilds the #6581 3/32" carbide diff balls. Refer to the diff section to correctly reassemble the diff.

CLEANING YOUR CAR. You can clean your car with many products, some of which may also be safe for cleaning electronics or some which may also be safe for cleaning the Lexan body. Electronics parts cleaners will clean your car, motor and electronics. They are very convenient and work well, but they can be expensive. There are also motor cleaning sprays which will clean the car and motor but are harmful to plastics like servo and receiver cases. Like electronics cleaners they work well but can also cost a lot. You can keep the maintenance cost by cleaning the car with household cleaners like 409, Fantastic, Simple Green or other general purpose cleaners. These cleaners have water in them so they are not recommended for use on motors or electronics. Because of the water you must also prevent rust on the cars steel parts (axles, dog bones, diff outdrives, etc.). You can do this by carefully drying the parts or spraying them with WD40 to seal the parts from moisture (after they have been cleaned) so they will not rust. The rust will not affect the performance of the vehicle or parts, just its appearance. **WARNING!!** Most of these cleaners have chemicals that will affect the Lexan body. Carefully test the product before you use in on your body. They can dry out the Lexan and cause the body to crack.

Associated has recently released our new #711 Reedy Car Wash, which cleans both your car and Lexan body (it is biodegradable and Lexan safe), but cannot be used to clean motors or electronics.

DS SETUP & TUNING TIPS

Your new DS is one of the most tunable fun cars on the market. This section will try to explain the adjustments so you can tune it for any track or condition.

DIFFERENTIAL ADJUSTMENT. Once the differential has been correctly adjusted, there should be no need to change it until rebuilding time. **1)** Gently tighten the diff spring and screw until it stops, **and then back out the screw 1/8 turn, being careful to be extremely accurate backing the screw out.** **2)** On a new or just-rebuilt differential, apply a small amount of throttle while holding one of the rear wheels stationary. Do this for about 15 seconds. This will correctly seat all of the differential parts. **3)** Now recheck the diff adjustment by again following step 1 above.

TORQUE CLUTCH (SLIPPER) ADJUSTMENT. It is possible to overtighten the torque clutch. If you do, you may

increase the wear on the differential. To prevent this, take your time when making clutch adjustments. On a new or just-rebuilt torque clutch, run the setting a little on the loose side for about one minute before readjusting to race settings. It is important to keep in mind that spinning the tires is not putting the power to the ground. **The purpose of the clutch is to gain traction, not to spin the tires uncontrollably.** With a fully charged battery you should be able to accelerate hard without hearing the torque clutch slip but do not tighten up the torque clutch any further because it can cause the diff to slip instead, which increases wear on the diff. If you are able to actually spin the tires on the surface then you can adjust the torque clutch to get maximum advantage of the motor but not spin the tires. On a high traction surface you can adjust the torque clutch a little tighter than you would on a low traction surface.

CASTER describes the angle of the kingpin, in relation to a vertical plane, when looked at from the side of the car (fig. 153). As an example, 0° of caster puts the kingpin in a vertical line. Positive caster means the kingpin leans rearward at the top. Caster has several effects. Increasing the positive caster on your car will increase the steering turning into a corner and slightly decrease steering coming out of the corner. Reducing the positive caster will decrease the amount of steering you have going into a corner and increase the amount of steering you have in the middle and exiting the corner.

Note: We are using the same caster blocks that we use in our off road cars so the caster indicated on the front carrier blocks will be different because of the different nose plate kickup angle. On our off road cars the kickup angle is 30°. For the new DS car the new kickup angle is only 8°. This means our 30° caster blocks will actually give you only 8° of caster on the DS.

The following caster blocks will work on the DS:

Part	Description	Results on DS Car
#6210	30° caster front carrier block	8° caster
#6215	25° caster front carrier block	3° caster

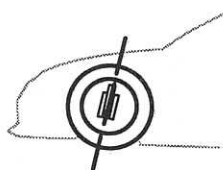

8° positive caster

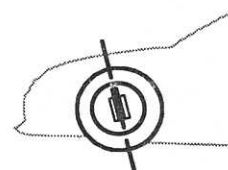

negative caster (not used)

Fig. 153

ADJUSTMENT:

Change front block carriers.

EFFECT:

Reducing caster: decreases steering into corners, increases steering at middle and end of corners.

Increasing caster: Increased steering at beginning of corners, more understeer out of corners.

RECOMMENDED: 8° caster.

POSITIVE CASTER OPTIONS: #6215, Front block carrier, 25° caster. #6210, Front block carrier, 30° caster, included in kit.

We do have other caster blocks, but they will only give you

negative caster and are not recommended.

CAMBER is a word describing the angle at which the tire and wheel rides relative to the ground when looked at from the front or back (fig. 154). This is one of the most important adjustments on your car. Negative camber means that the tire leans inward at the top, putting it closer to the centerline of the car than the bottom of the tire. Positive camber means just the opposite, the top of the tire is further away from the centerline of the car than the bottom of the tire.

Excessive negative camber will take away traction but increase stability. Positive camber will also take away traction but decrease stability. A tire's maximum traction is achieved when it is perpendicular to the ground (straight up and down). For the rear tires this will cause understeering in most conditions and possibly traction rolling in high traction conditions. **Also, we want to adjust camber to achieve even tire wear to the best of our ability.**

We suggest a starting setting of 2° of negative camber for both front and rear. If you want to add a little more steering, reduce front camber to 1° negative or even 0°. Keep in mind that using little or 0° of camber will cause the car to slide unpredictably. Try to use at least 1 to 2° negative camber at all times. This can be adjusted by turning the upper control rod turnbuckles (front or rear) in the appropriate direction.

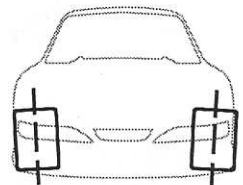

DO NOT USE positive camber

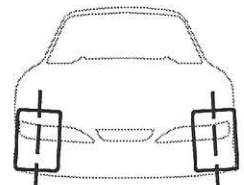

USE THIS negative camber

Fig. 154

ADJUSTMENT:

Turn upper control rod turnbuckles.

EFFECT:

Negative (more than 2°): less traction, more stability.

Positive: less traction, less stability.

0° to 2°: maximum traction.

RECOMMENDED: 2° negative camber front and rear.

FRONT TOE-IN AND TOE OUT. (Fig. 155). Adding toe-in to the front tires helps stabilize your car under acceleration, but at the same time it removes a small amount of turn-in steering. Toe-out will add turn-in steering, but will reduce stability under acceleration. Both toe-in and toe-out will scrub speed, so try to use as little as possible of either.

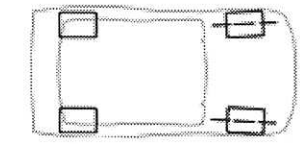

front toe-out

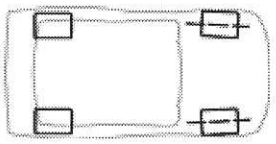

front toe-in

Fig. 155

ADJUSTMENT:

Front toe-in and toe-out can be changed by adjusting the steering tie-rod turnbuckles.

EFFECT:

Front toe-in: improves stability during acceleration; less turn-in steering.

Front toe-out: causes instability during acceleration, and more turn-in steering.

RECOMMENDED:

Starting setting of 0° of front toe-in. Our Team almost never uses front toe-out.

REAR TOE-IN. Rear toe-in affects steering and rear traction. Decreasing rear toe-in increases steering, but decreases rear traction. Your new RC10DS comes with 1.5° toe-in per side rear suspension mounts and 0° toe-in rear hub carriers. To change the rear toe-in you must switch the rear suspension mounts and/or hub carriers. The standard mounts and hub carriers on your car will work for most tracks, but you can change the rear toe-in for different tracks. Maximum recommended rear toe-in is 3° per side, but it is rarely used.

ADJUSTMENT:

Changing rear suspension mount and hub carriers.

EFFECT:

Rear toe-in, increased: reduces speed; less steering, more rear traction.

Rear toe-in, decreased: increases speed; more steering, less traction.

OPTIONAL PARTS:

Rear suspension mounts:

#7363 3° toe-in per side

#6360 1.5° toe-in per side (included in kit.)

Rear hub carriers:

#7365 0° toe-in per side (included in kit)

#6366 1.5° toe-in per side (requires #9277 ball bearing to fit DS universal axles.)

WHEELBASE ADJUSTMENT. The RC10DS wheelbase can be changed easily to allow further fine tuning of your car. This can be accomplished by moving the #6466 1/8" plastic spacer on the rear outer hinge pin (next to the rear hub carrier) to the other side of the rear hub carrier (fig. 156). The standard position places the spacer behind the rear hub carrier. This is the shortest wheelbase position and gives the most rear traction and a slight amount of understeer (push). Moving the spacer in front of the rear hub carrier will lengthen the wheelbase and at the same time increase steering entering and exiting corners, but decrease rear traction. This position will also improve handling on bumpy track conditions.

These adjustments may seem backwards, but you are shifting a large amount of weight front to rear by moving the rear axle position. The actual difference in wheelbase length is insignificant compared to the change in front to rear weight transfer. As an optional fine tuning setup you can replace the 1/8" spacer with two #6466 1/16" spacers, placing one on each side (or four 1/32" spacers placed three on each side) for a less significant change. (The Associated #6466 kit contains 1/32", 1/16" and 1/8" spacers.)

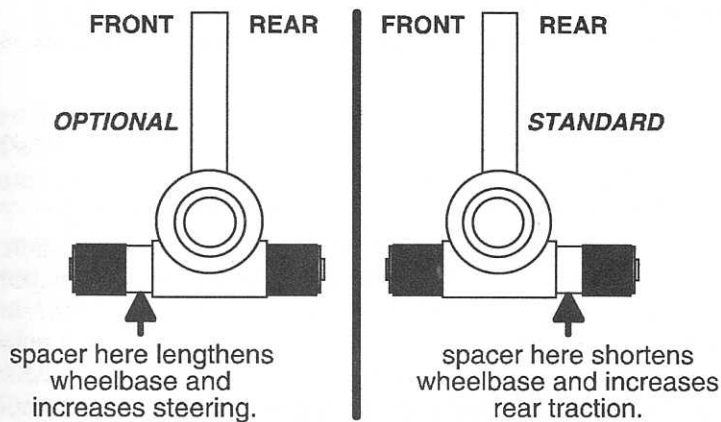

Fig. 156

CHASSIS RIDE HEIGHT. We recommend a starting ride height of .40" or 10.15mm for both the front and rear. Because the body is a significant amount of weight, this will drop the actual running ride height down to about 3/8" or 9.5mm, which is what we feel is a good height for most surfaces. We also try to keep the chassis fairly close to level most of the time. You adjust ride height by adding or subtracting to the thickness of the #8846 shock preload clips. If you are going to raise the ride height you would increase the thickness of the clips installed on the shocks that need to be changed. Lowering the ride height will require reducing the thickness of the preload clips.

The easy way to check ride height is to place the car on a table or work bench that is flat bring the back or front wheels up to the outer edge of the table. Push the suspension down on the end of the car you are currently working on several times, letting the car settle into its own ride height. Now measure from the top of the table edge to the bottom of the chassis. Please note that with the tires at the edge of the table when you measure from the table edge you will be coming up directly under the chassis on either end of the car.

REAR SHOCK POSITION. On the DS you only have the ability to change the position of the upper mounting point on the rear shock. The standard outer hole position allows the suspension to work better on bumpy or higher traction surfaces. When the inner mounting position is used the car will work better on smooth slick surfaces.

SHOCK SPRINGS: You have a couple of choices for optional springs for different conditions that will help you to tune for different tracks:

- #8231 Silver (softer than the stock kit spring)
- 8232 Black (standard kit spring)
- 6494 Green (more stiff than the standard kit spring)

REAR SPOILER HEIGHT. You have the ability to change the height of the rear spoiler above the back deck of the body on the Trans-Am style bodies. If you decrease the height of the rear spoiler above the rear deck you will decrease rear down force which will in turn decrease rear traction and increase steering. To reduce the height you will need to trim the spoiler with an X-

acto© knife or scissors. Use a straight edge to mark exactly where you want to trim off the spoiler.

ANTI-ROLL (OR SWAY) BAR TUNING. You have the ability to adjust both the amount of front steering and rear traction with either the front or rear anti-roll bar. You can adjust the stiffness of the roll bar by where you locate the #8830 aluminum roll bar pivots. If you have the pivots at the outer end of the anti-roll bar this will be the softest position. If you move the #8830 pivots further in on the anti-roll bar you will be stiffening the roll bar, which will decrease traction.

Very slight adjustments will make a fairly significant change in the car's handling so try to keep adjustments small. On extremely rough surfaces you can also disconnect the sway bars. This allows the car to handle better over the bumps or rougher surfaces. It will also give you a lot more traction but it does increase the body roll greatly. If the body roll is excessive you can run a heavier spring and or heavier shock oil which will help you make minor adjustments to the car's handling. The resulting effect on each end of the car is as follows.

FRONT ANTI-ROLL BAR: A softer front anti-roll bar setting will result in slightly more front body roll and more front traction, which will also give you more steering. A stiffer front anti-roll bar will reduce the the body roll and front traction, meaning you will have less steering.

REAR ANTI-ROLL BAR. A softer anti-roll bar setting will result in slightly more rear body roll and more rear traction. You will then have less steering because of the increased rear traction. If the rear anti-roll bar is stiffer, you will have less rear body roll and less rear traction, which will also mean you have more steering.

TWEAK. With the car ready to run (minus the body), disconnect one side of each front and rear roll bars' ball cups from the ball end on the suspension arm. Keep the other side connected. Place the car on a flat surface and push the suspension all the way down to the surface and then let go. This will let the suspension settle at ride height. Now starting with the rear anti-roll bar, adjust the length of the link we disconnected until it exactly matches the position of the ball end on the suspension arm. Once you have it adjusted correctly, go ahead and snap it back on. Now follow the same procedures for the front anti-roll bar. This process ensures that there is even pressure on all four tires.

MOTOR GEARING. You can get the most from your motor when it is geared correctly. The following are starting points for some of the motors that are listed in your RC10DS catalog.

STOCK MOTORS. The recommended starting final drive gear ratio for the motor that came in your bushing kit is 7.00:1. The kit stock motor is a 23 turn bushing spec motor (not ROAR or NORRCA legal for stock class). However, all 24° 27 turn stock motors that are legal for ROAR/NORRCA stock racing will use the same gearing because it has more advanced timing. Your choice of gear ratios will be further influenced, however, by the type of stock motor, motor timing, and other factors such as your track's length, traction, tight or open track, and competition level.

If you decided to run a 36° advanced stock motor you would have to consider reducing pinion size by one or two teeth to adjust for the higher motor timing.

MODIFIED MOTORS. For modified motors we have included a starting gear ratio chart for your new DS. This chart is based on using a six cell battery pack and the stock diameter rear tires. The gear chart is also the setup for a standard upright brush commutator motor. If you are using a large commutator motor with a laydown brush as in our Sonic or Sonic2 motors you will need to increase the pinion size by one tooth. Reedy has also developed special modified motors for the DS car and they are also indicated in the chart below.

Motor		Spur/Pinion	Final Drive Ratio
#586	17 turn triple wind	81/24	7.59:1
#587	15 turn triple wind	81/23	7.92:1
#588	14 turn triple wind	81/22	8.28:1
#589	13 turn triple wind	81/21	8.68:1
#590	12 turn triple wind	81/20	9.11:1
#591	11 turn triple wind	81/19	9.59:1
#592	10 turn triple wind	81/18	10.13:1

All of the above ratios are based on a medium size track. You may have to adjust your ratios if the track size is different.

FORMULA EXPLANATIONS AND EXAMPLES:

If you are not familiar with how final drive gear ratios are calculated the following shows how it is done. Based on an actual 81 tooth spur gear, 20 tooth pinion gear, and a Stealth transmission ratio of 2.25:1.

Actual Spur/Pinion Ratio	Pinion Ratio	Gearbox Ratio	Results
(81 / 20) = 4.35		2.25	9.11
9.11:1			

How to determine starting pinion size based on a recommended final drive ratio and chosen spur gear size. Spur gear size = 81, final drive ratio = 8.0:1

Starting Spur / Pinion	Drive Ratio	Results	Gearbox Ratio	Actual Size
(81 / 8.0) = 10.125	x	2.25	=	22.78 (=23)
(always round to the nearest whole number, there is no such thing as a partial tooth on a pinion gear).				

BATTERY CHARGING

It is important to understand the characteristics of the battery pack in your car because how you charge and use it will greatly affect both its performance and its life. With proper care your pack will perform well for many hundreds of cycles.

The ROAR legal battery for use with your car is composed of six "sub-C" size cells (your car is only designed to use six cells) with a rated capacity of between 1.2-1.8 amperes for one hour, or 2.4 amperes for 1/2 hour, etc. This charge capacity is the same regardless of the number of cells in the pack because the cells are connected in series and the same current passes through each one.

CHARGER. A good quality, automatic charger will last longer than an economy unit, so please do not cut yourself short here by trying to save a few dollars. Any good name brand charger will do the job correctly. **Associated recommends a peak detection charger as opposed to a timer charger.** Timer chargers increase the chance of making a mistake when charging the battery, and increases the chance of damaging the battery pack. Peak detection chargers have an internal circuit that monitors the voltage and charge rate of the battery pack. When the pack is fully charged, the voltage will begin to decrease and this charger will detect this and either turn the charger off, or down to a trickle charge. Some chargers have even more sophisticated features than this that can make charging less of a hassle or less time-consuming. The better chargers like this also are designed to handle the heavy back-to-back charging that can be common when racing or playing for a long time. The choice of a DC only or an AC/DC charger should be based on personal needs (where you will be using your car) and budget.

OVERCHARGE. There is no way to make a Ni-Cd cell accept more charge than it is designed to hold. This means that as the cell approaches a fully charged condition, the portion of charging current not being stored becomes heat and pressure. If charging continues after the cell is fully charged, all of the current is converted to heat and pressure—about 40 watts worth, or the equivalent of the heat produced by an average soldering iron. High temperature and pressure is damaging to the cells, so overcharging must be avoided.

Ni-Cd cells have a built-in process for recombining the accumulated gas (actually oxygen) produced by overcharge, but the process produces heat and takes a lot of time. If you overcharge your battery and it seems to take a long time to cool down, it's because this pressure reducing reaction is taking place. Once the gas is recombined the temperature drops.

HOW TO TELL WHEN YOUR CELLS ARE CHARGED

One of the problems with Ni-Cds is their inherent voltage stability; the voltage of a fully charged cell is not much different from one that is fully discharged. If you have a peak detection charger you do not have to worry about the following

information unless you just want to understand more about batteries in general. If you do not have a peak detection charger then the following battery information is extremely important for you. What follows is a list of techniques and indicators you can use to detect when a battery is fully charged.

SLOW CHARGE METHOD. Slow or "overnight" charging is a method you are not likely to use often, but it is a good way to bring the pack to absolutely full charge. However, the output voltage of a slow charged pack is slightly lower.

The charging current must be between 0.05 and 0.12 amperes. If less current, the pack will never reach full charge; any more and the pack will overheat. The time required to reach full charge ranges from 15 to 40 hours, depending on the the current used. The charger can be left on for a much longer time without harming the cells; however, the output voltage of the pack will be temporarily lowered by an extremely long overcharge. The voltage returns to normal after a discharge-charge cycle.

These next two tips are for the benefit of serious racers. If you're just out having fun, don't worry about them.

FULL DISCHARGE. Ni-Cd packs perform best if they are COMPLETELY discharged before they are charged. If you are involved in racing, you will have to do this if you expect to win any races! Discharge for at least an hour (preferably overnight with a clip-on resistor) before charging.

TOPPING-UP can give you a little extra voltage at the beginning of a race, as long as you don't overdo it. Put the last minute or two of charge into your pack just before the race starts.

CAUTION

Ni-cad batteries are susceptible to damage when overcharged at a high rate, and can release caustic chemicals if the overcharge is severe.

Do not stall the motor under power. If the car stops suddenly on the track, or fails to move forward when you attempt to accelerate, push the throttle control on your transmitter to the brake position immediately and attend to your car. A small rock can stall the gears, and if the throttle is left in the on position the result can be a burned out motor (or electronic speed control unit).

If you run your car to the point where more than one cell in the pack is completely discharged, it is possible to lose radio control of your car before the drive motor stops completely. For this reason you should not operate your car in an area where it could be harmed or cause harm, such as near a busy roadway or a pool of water. Usually radio control will be regained as soon as you pick up the car and the motor is allowed to free-run. If you still don't have control, then you should unplug the motor.

When you stop running your car, turn off the radio **at the car first before** turning off the transmitter.

A burned-out or shorted motor can make the car appear to have radio problems. If your car slows down suddenly and the radio acts erratically even with a full battery charge, then the cause is probably the motor. Check the range of the radio with the motor unplugged. A shorted motor will draw extremely high current even under no-load conditions.

SAVE THIS MANUAL!

MORE THAN AN INSTRUCTION MANUAL, IT'S ALSO A HANDY PICTORIAL SUPPLEMENT TO TEAM ASSOCIATED'S RC10DS CATALOG. REFER TO THIS MANUAL FOR PART NUMBER AND NAME WHEN ORDERING.

FROM TEAM ASSOCIATED

RACING Gear

SEE FULL DETAILS OF THESE ASSOCIATED PRODUCTS AND MORE IN THE CATALOG



TEAM ASSOCIATED JACKET
(front shown) #SP-410, \$59.95*,
M, L, XL, XXL, XXXL

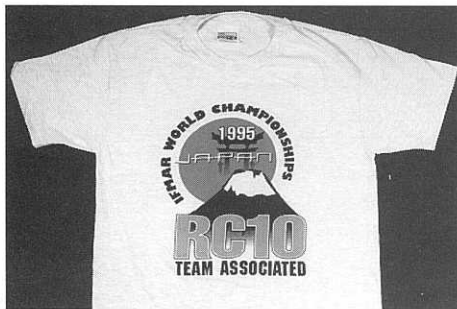

1995 JAPAN WORLDS T-SHIRT
(front shown) #SP-36, \$11.00*, M, L, XL



ASSOCIATED CAP
#SP-405, \$15.95*

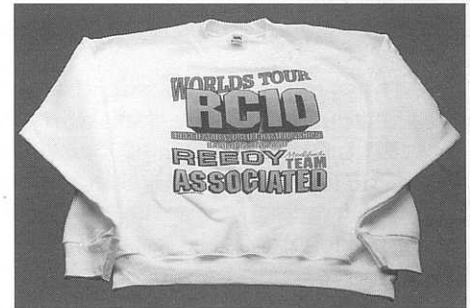

WORLD TOUR SWEATSHIRT
(front shown) #SP-400, \$19.95*, L, XL, XXL



CAR CARRIER BOX
#SP-100, \$15.00**

(with 3 inner boxes). Due to its larger size, an additional \$15.00 must be added to UPS standard shipping charges

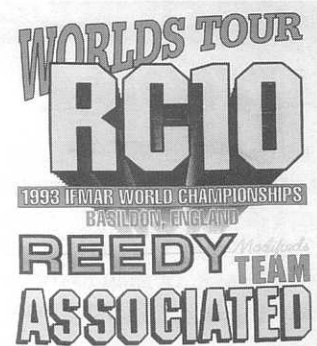

OFF ROAD WORLD TOUR T-SHIRT
(front shown) #SP-35, \$11.00*, M, L, XL

ON ROAD WORLD TOUR T-SHIRT
(front shown) #SP-34, \$11.00, M, L, XL

CAR CARRIER BAG
#SP-415, \$39.95**

3 INNER BOXES
#SP-101, \$5.25**

SHIP TO: (PRINT CLEARLY)

NAME: _____ DAY PHONE: (____) _____

ADDRESS: _____

CITY / STATE: _____

COUNTRY / ZIP CODE _____

MAIL ORDER TO:



ASSOCIATED ELECTRICS, INC.
3585 CADILLAC AVE.
COSTA MESA, CA 92626 U.S.A.

PHONE

(714) 850-9342
MON - FRI
8am to 4pm PST

FAX

(714) 850-1744
Anytime. Print legibly!

ORDER FORM (PRINT CLEARLY)

PART #	DESCRIPTION	SIZE	QTY	x PRICE EA	= TOTAL

SUB-TOTAL	
CA residents: 7.75% tax in O.C., 6.25% elsewhere	
C.O.D. FEE (\$4.75)	
SHIPPING	\$4.25

PAYMENT

In U.S.A.: Mail your order with check or money order. Or Mail, Phone or Fax order as C.O.D. order. **DO NOT SEND CASH. NO CREDIT CARD ORDERS.**

Outside U.S.A.: Mail your order with international money order only. **DO NOT SEND CASH. NO CREDIT CARD ORDERS.**

* denotes non-standard discount item.
** denotes net or short discount item.