



RE

RC10 GRAPHITE INSTRUCTION MANUAL

RE TEAM ASSOCIATED

RC10 Graphite's Latest

NEW REAR HUB CARRIERS

NEW IDLER GEARS

**NEW TURNBUCKLES,
FRONT AND REAR**

NEW GRAPHITE CHASSIS

NEW LOW PROFILE REAR WHEELS

NEW REAR UNIVERSAL-DOGBONE/STUB AXLE

NEW LOW PROFILE REAR TIRES

© 1989 ASSOCIATED ELECTRICS, INC.

Advanced, Competition

Technology

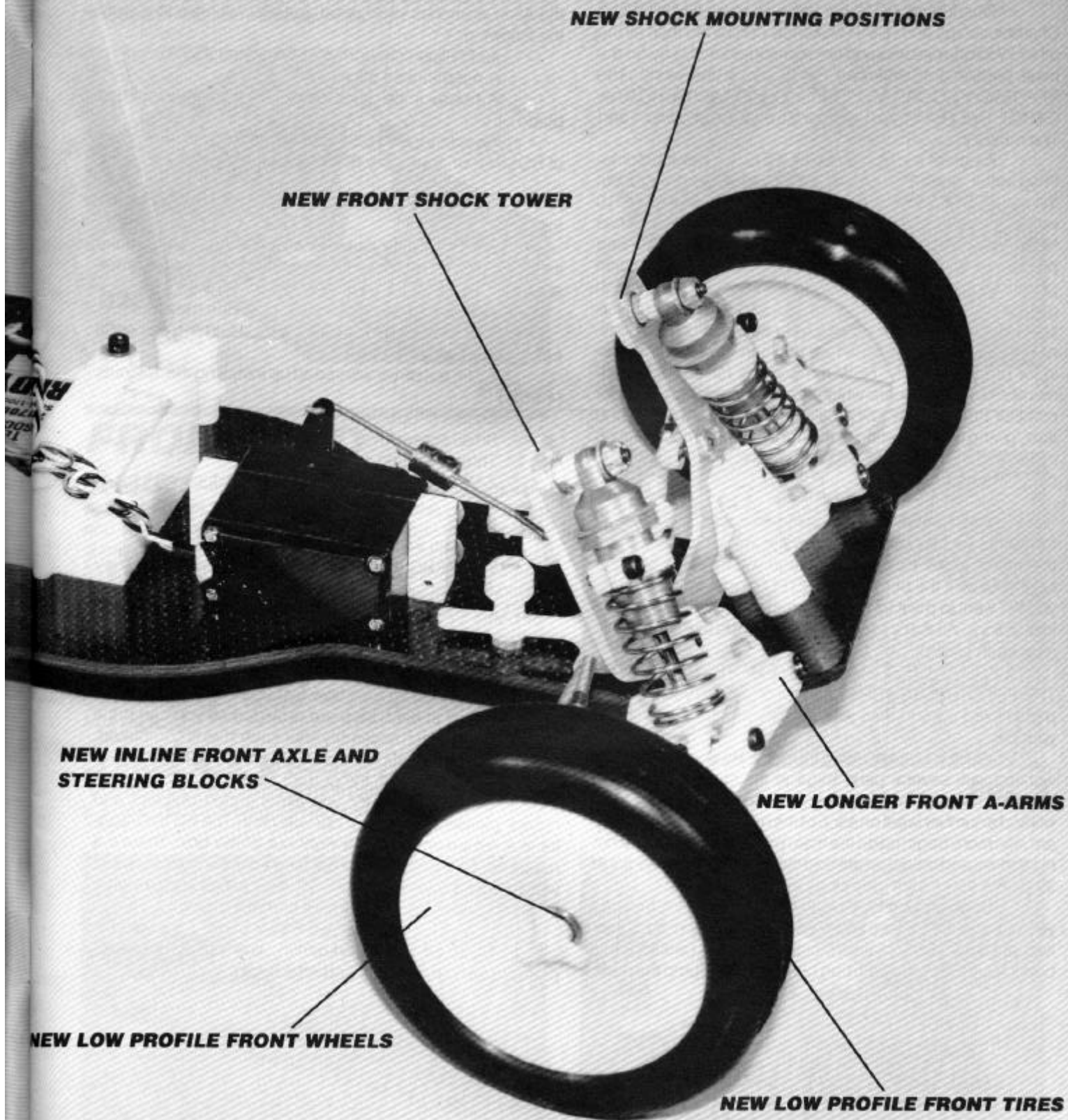

NEW SHOCK MOUNTING POSITIONS

NEW FRONT SHOCK TOWER

NEW INLINE FRONT AXLE AND STEERING BLOCKS

NEW LONGER FRONT A-ARMS

NEW LOW PROFILE FRONT WHEELS

NEW LOW PROFILE FRONT TIRES

Version of the RC10

FIRST, A WORD

Your RC10 GRAPHITE car is the latest state-of-the-art, 2WD off-road racer in the world. There is none better.

Our original RC10 car has won more IFMAR World Championships and ROAR Nationals combined than all the other 2WD off-road winning cars put together. It is by far the most popular 2WD off-road RACE car in the world. The READERS of RC CAR ACTION magazine voted the RC10 as CAR OF THE YEAR by a 6 to 1 margin over the 2nd place car! The racers know which car is best.

As great as the original RC10 is, we wanted something better, and we know you did too, so we've brought out the new RC10 Graphite. At first glance it looks like an RC10 with a graphite chassis. But it's much more than that. It has NEW longer front A-arms with two NEW shock mounting positions. NEW inline front axle and steering blocks which greatly improve the steering. NEW front shock towers which give more ideal shock mounting positions. NEW rear universal-dogbone driveshaft, giving freer suspension and eliminating lost dogbones. NEW rear hub carriers with more toe-in for greater stability. NEW turnbuckles for easier adjustments. NEW idler gears which are strong enough even for monster trucks. NEW low profile front and rear wheels and tires, giving more steering in the front end and more traction in the rear end. Which all adds up to give you the best 2WD car in the world.

You'll find the photos in the instructions so easy to follow that you may be tempted to put the car together from the photos alone. However, although you have the best car kit, if you want the best COMPLETED model race car, then you will want to put it together correctly—by following these instructions. All that's required is to read the few lines of text near each photo.

DON'T OPEN ANY OF THE PARTS BAGS UNTIL THESE INSTRUCTIONS TELL YOU, otherwise you'll get the parts mixed up and then you will have trouble assembling your car.

While you are building the car you will sometimes be working with several parts bags at the same time. These bags are referred to by number in the instructions, and you will find a number label on each of the main parts bags. There are also more bags inside the main parts bags; these are not numbered and belong to the bag they came out of. See page 39 for the list of parts and bags in your kit.

Bags and parts will start multiplying like rabbits as you build, so try to keep the bags separate. One good way is to use large paper plates (picnic plates with partitions are best). Mark the plates with bag numbers and dump the parts

into them. When the parts are used up, relabel the plate for another bag. It's much easier to find the part you need if it's spread out where you can see it.

TOOLS. The kit contains the shock wrench and all the Allen wrenches you'll need, but you will have to supply the following:

#2 Phillips screwdriver (Associated #SP76)

A needle-nose pliers

A hobby knife, such as an X-acto with a pointed blade

A soldering iron (25 to 50 watts), and a small amount of ROSIN (not acid) core 60/40 solder.

The kit can be assembled even easier if you have the following:

3/32" straight Allen wrench with handle. Will make installing the Allen screws much faster and easier (Associated #SP73)

A ruler with decimal inches or metric measure

A 3/16" nut driver will make installing the ball ends easier (Associated #SP86)

A 1/4" nut driver will speed up installing the 1/4" nuts (#SP85)

Socket or open-end wrench

Small screwdriver

Thread-locking compound

ZAP or Hot Stuff (cyanoacrylate adhesive)

Vise

File

Drill with #43 (2.3 mm) bit

WARNING! Do not use a power screwdriver. They spin too fast, causing screws to heat up when being driven into plastic and will strip out.

Take your time assembling the car. It's not a race to see how fast you put the car together; it's how well you put it together that determines how fast you'll be able to race.

Boxes at each step are provided so you can put a check mark for each assembly after each step is completed. So when you stop during assembly time, you'll be able to come back and start in the correct step.

One final note for you experienced builders and racers: please build the car our way first!! The RC10 Graphite is a remarkably fast car right out of the box. There's a reason for everything on the car, and very few compromises were made in its design. Work with the car first and see what it can do before you experiment or make changes.

Clear off your workbench, line up some paper plates, grab a sandwich, and *let's begin*. . .

BODY MOUNT

FIG. 1—We'll start with Figure 1. Pull out the graphite chassis #6305. From Bag #6-5 take out the front body mount #6330 and one aluminum screw #6280.

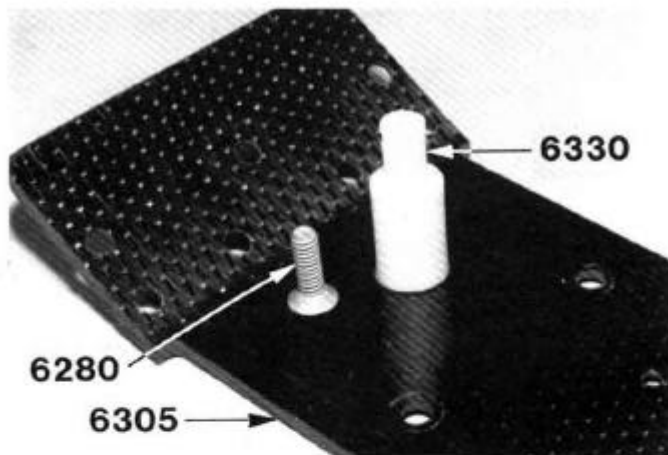

FIG. 1

FIG. 2—Install the front body mount as shown with a #2 Phillips screwdriver while holding the body mount with a pliers. Make sure you start the screw in straight. As soon as the screw tightens, stop twisting, or else you will strip out the plastic.



FIG. 2

FRONT END

FIG. 3—Empty Bag #6-1 onto a plate. Take out the parts as shown for the left hand side. Slip the pin into each end of the front A-arm #6206 to check the pin fit. The A-arm should be able to swing freely on the pin. Most racers keep a .126" and .128" reamer in their toolbox to free up A-arms and to clean them after racing. We want the pin to fit tight in the mount #6207. You'll find the E-clips #6299 taped together. With the aid of a small screwdriver, put one clip into the groove in one end of the shaft, put the parts together as shown in Fig. 4, slide the shaft in, make sure it swings freely, then put the second E-clip on. Now assemble the right hand side parts.

FIGS. 4, 5, & 6—Assemble and install the left hand mount to the chassis with the parts shown in Figs. 5 and 6. Again, do not overtighten the screws.

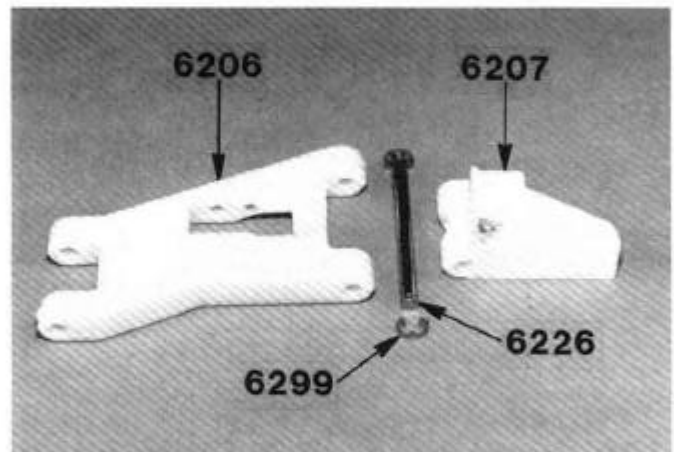

FIG. 3

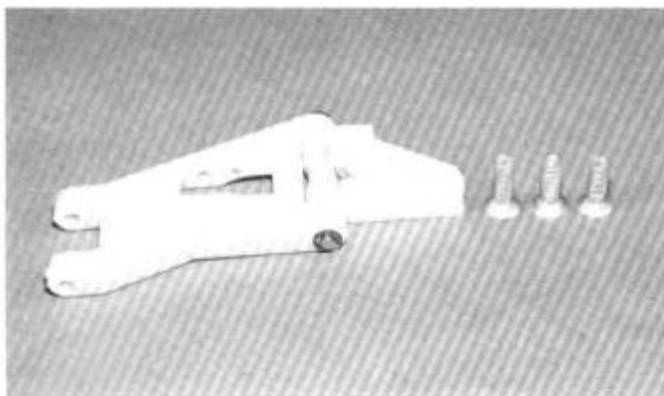

FIG. 4

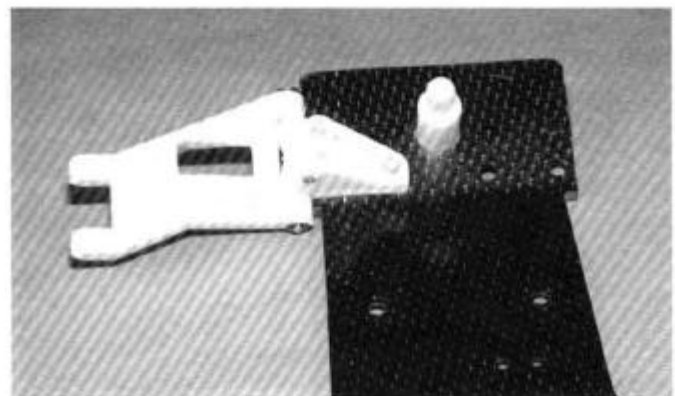

FIG. 5

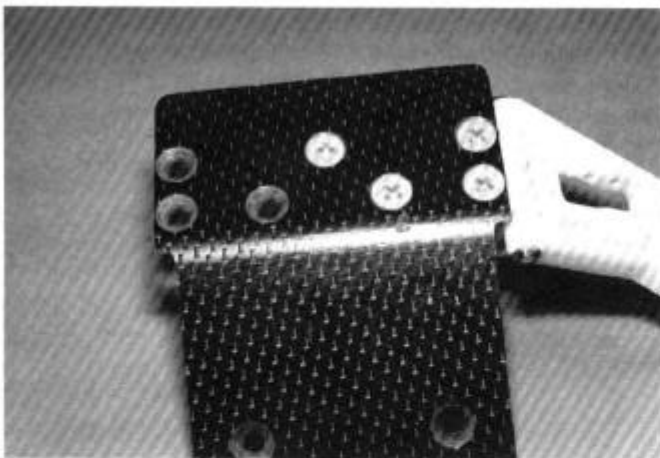

FIG. 6

□ **FIG. 8**—From Bag #6-2 push up the two long 8-32 screws and lock with the two nuts as shown.

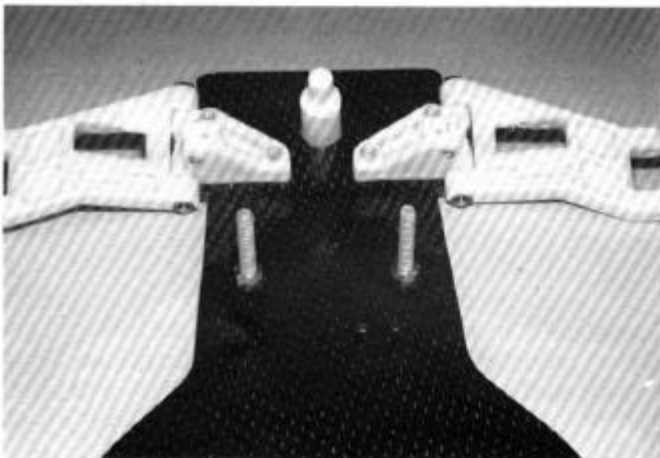

FIG. 8

□ **FIG. 10**—Push the front axle #6218 into the steering block #6217 as shown so the hole in the axle lines up with the hole in the steering block. It may push together with your fingers. If not, LIGHTLY tap it into the hole. Assemble the right hand side in the same way.

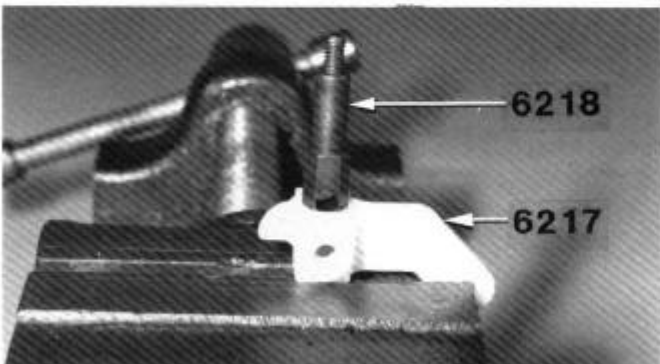

FIG. 10

□ **FIG. 7**—Now install the right hand mount.

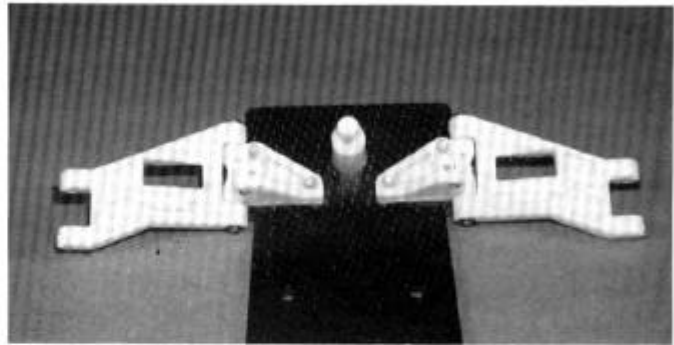

FIG. 7

□ **FIG. 9**—From Bag #6-1 screw the long ball end #6273 into the left hand front block carrier #6213 as shown, then screw on the locking nut. Assemble the right hand parts.

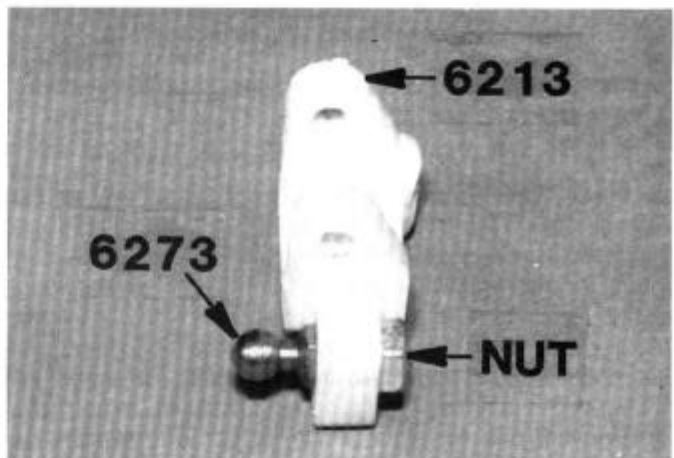

FIG. 9

□ **FIG. 11**—Screw the short ball end #6270 into the steering block and secure it with the nut as shown. Assemble the right hand side, which will be inserted into the opposite side shown in Fig. 11.

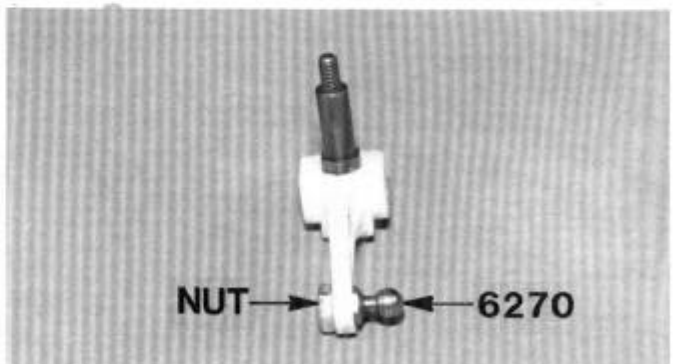

FIG. 11

FIGS. 12, 13 & 14—Join the left hand block carrier and the left hand steering block with the pin #6223 and E-clips as shown. Assemble the right hand side.

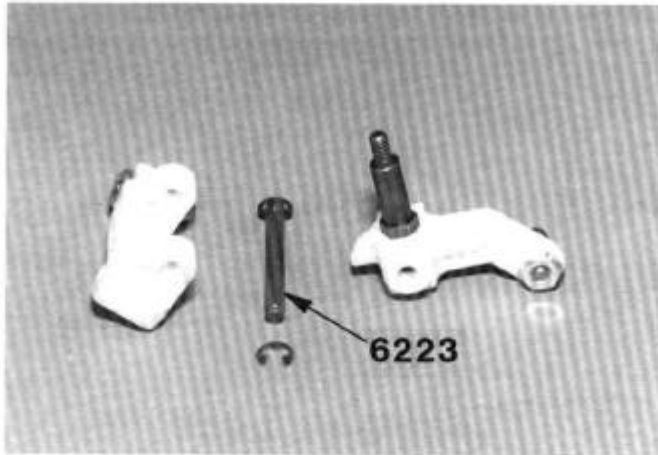

FIG. 12



FIG. 13



FIG. 14

FIGS. 15 & 16—Connect the left hand front steering block assembly onto the left hand arm with the pin #6227 and E-clips as shown. Connect the right hand parts.

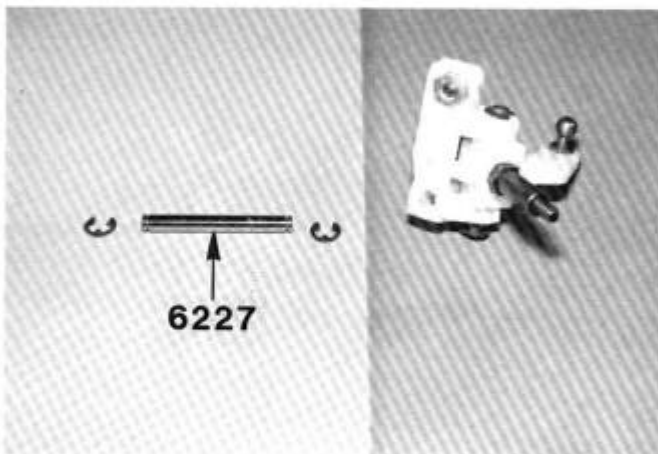

FIG. 15

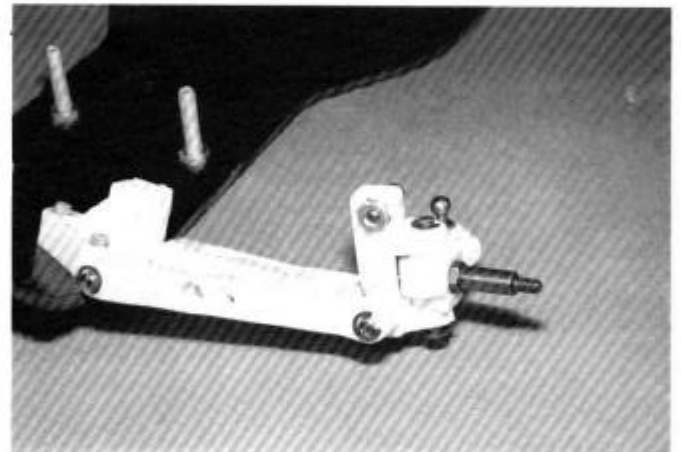

FIG. 16

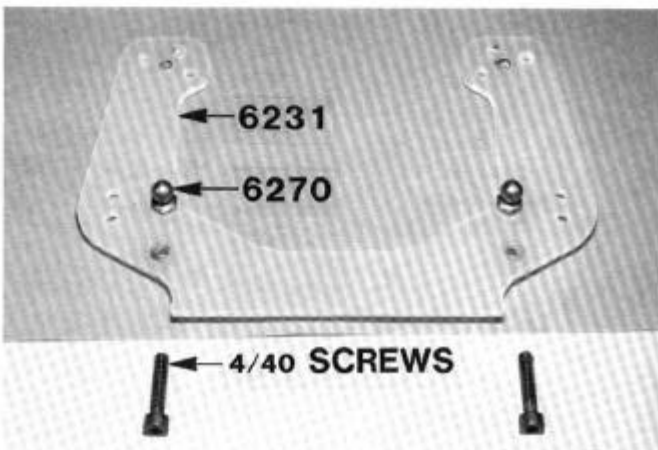

FIG. 17
page 7

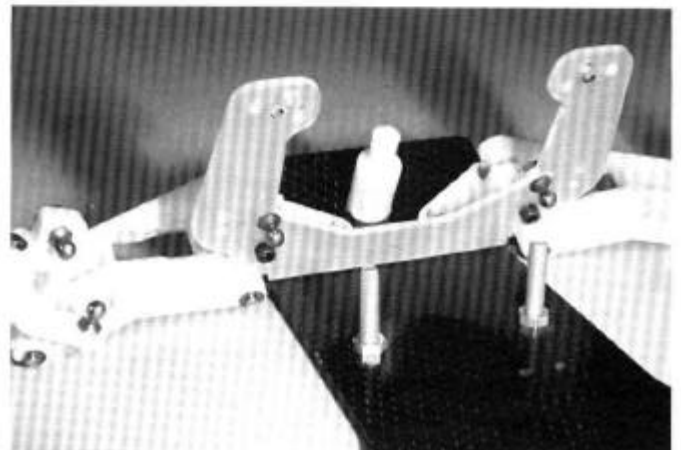

FIG. 18

□ **FIG. 19 & 20**—In Bag #6-2 there are seven threaded turnbuckles #6259. There is one short one, two long ones, and four medium ones. Take two of the medium

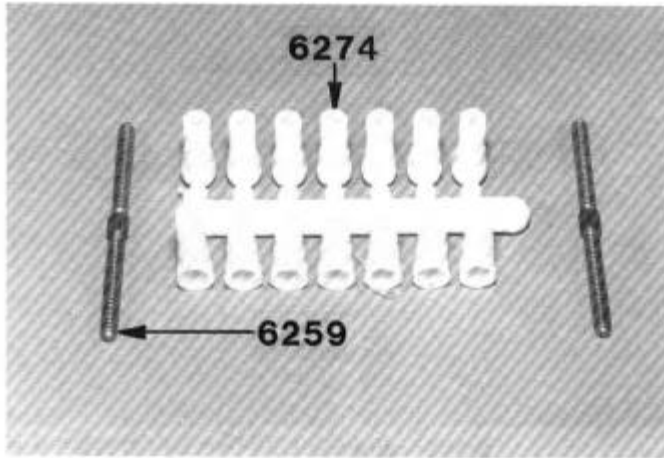

FIG. 19

ones and thread on four of the plastic ends #6274. There are left hand and right hand threads on each rod. We want to end up with linkages that are 2.05' long (52.40 mm), measured from the center of the ball cups as shown in Fig. 20.

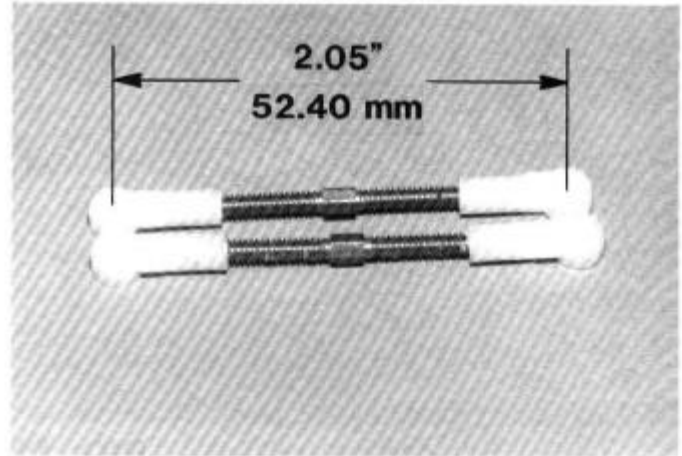

FIG. 20

□ **FIG. 21**—Now pop the linkage onto the balls as shown. Assemble the right hand side too.

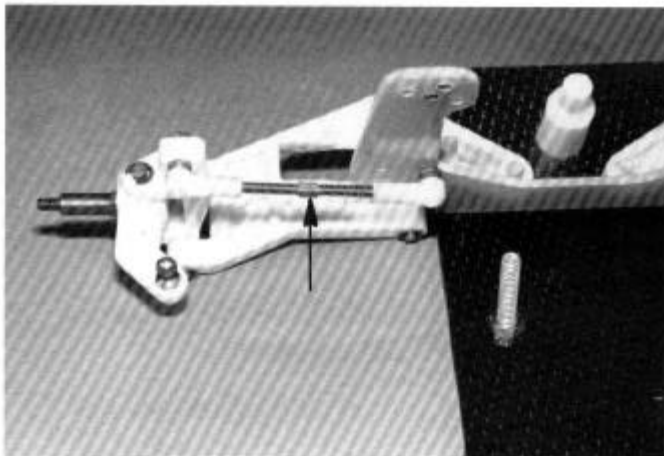

FIG. 21

□ **FIGS. 22, 23 & 24**—From Bag #6-2 take out the servo saver #6255 and screw on four of the ball ends as shown in Fig. 22. Then take the servo saver arm (shown in Fig. 23) and install it as shown in Fig. 24.

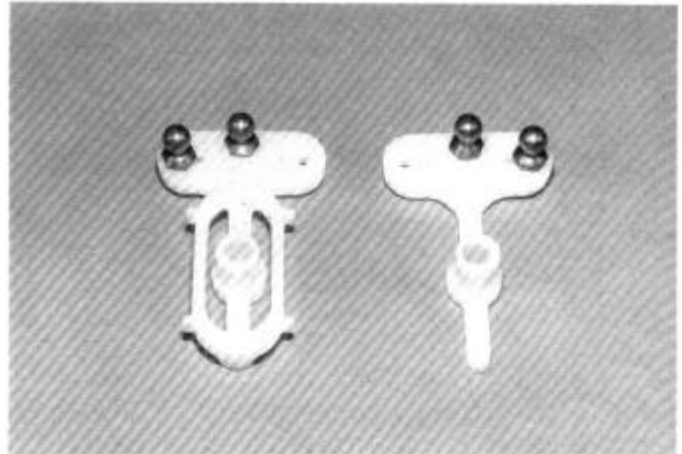

FIG. 22

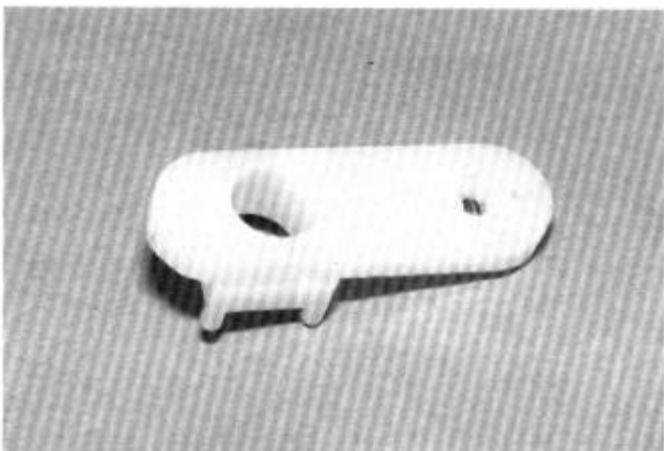

FIG. 23
page 8

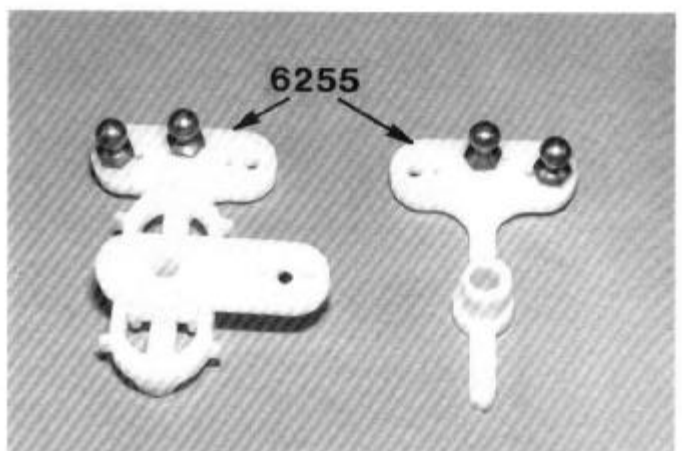

FIG. 24

FIG. 25—Place the servo saver parts on the two screws you installed in Fig. 8. Take the two nylon nuts and screw them down until the servo saver starts to tighten, then back the nuts off about 1/2 turn until the servo saver arms pivot freely.

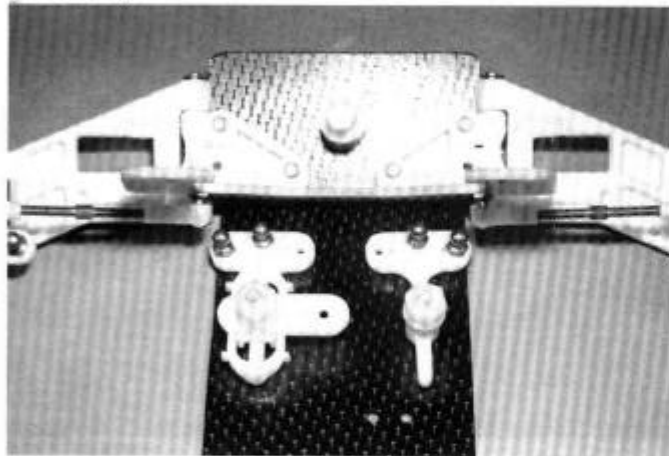

FIG. 25

FIG. 27—Pop on the center tie rod linkage as shown.

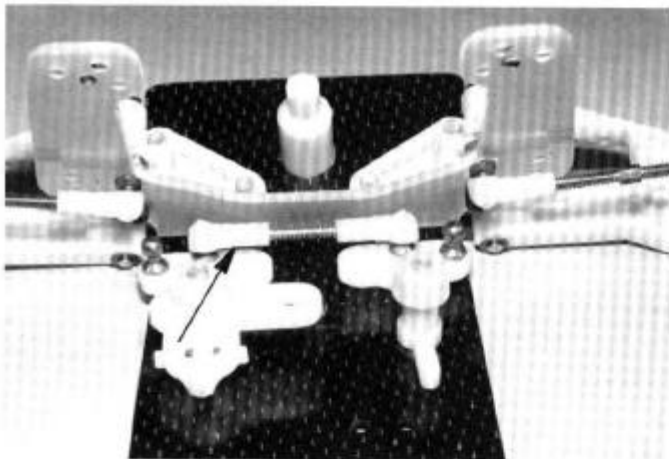

FIG. 27

FIG. 26—Take the two long and one short turnbuckles and screw on the six plastic ball cups to the lengths shown.

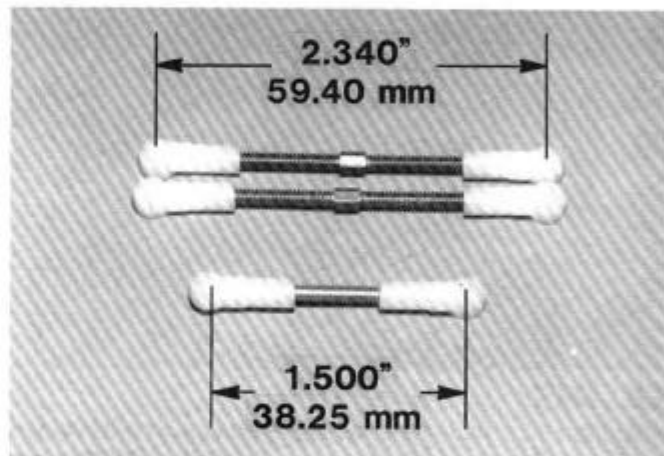

FIG. 26

FIG. 28—Pop on the right hand and left hand linkages as shown.

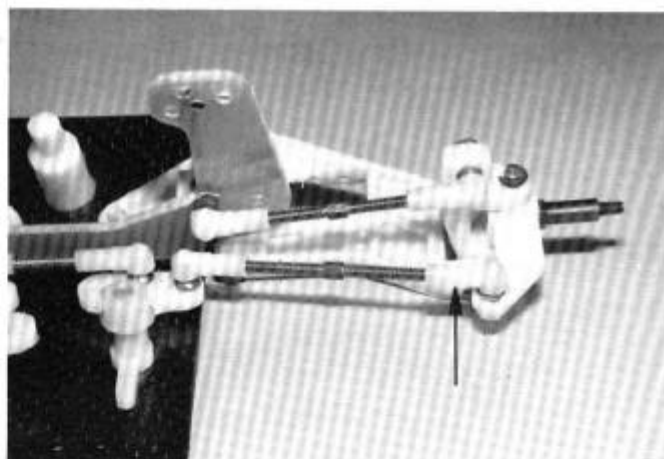

FIG. 28

TRANSMISSION

FIG. 29—From Bag #6-12 take out the drive gear pivot #6609. Also in Bag #6-12 is a small bag with screws. In this bag is a small split roll pin. Use a needle-nose pliers to hold the pin and lightly tap it into the hole. . .

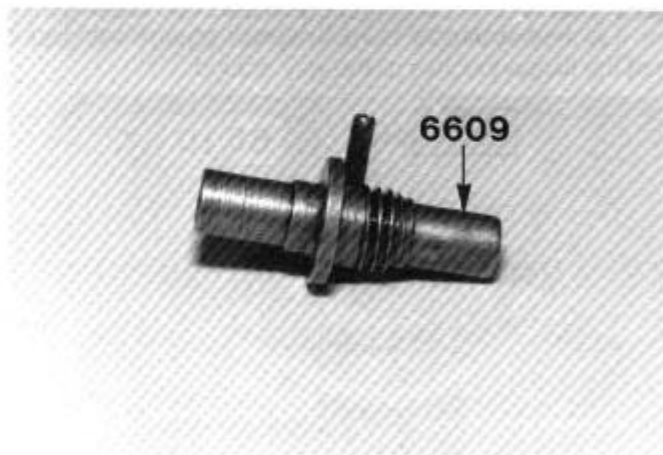

FIG. 29

FIG. 30—Tap the pin into the hole so it sticks out the same on both sides.

FIG. 31—Take the aluminum spine plate #6611 out

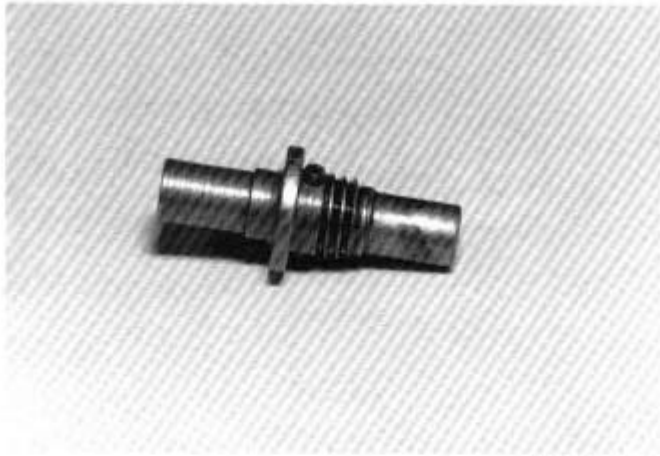

FIG. 30

of the Bag. Using a vise or a piece of wood with a 1/4" hole in it, carefully tap the pivot into the plate. Make sure the pin is centered inside the slots in the plate, and that the flange of the pivot is flush against the surface of the plate.

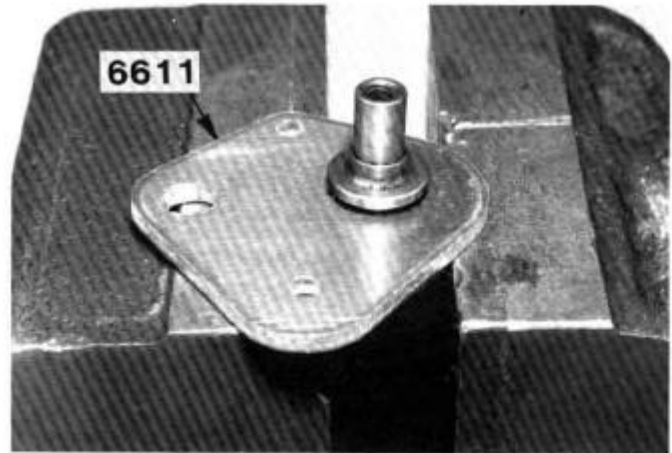

FIG. 31

FIG. 32—Take the thin 1/4-28 hex nut out of the Bag. Turn the plate over and screw on the nut. Tighten the nut with a socket or open-end wrench while holding the spine plate. You may want to put a drop of thread-locking com-

pound on the threads to make sure the nut doesn't come loose.

FIG. 33—The pivot should look like this so far.

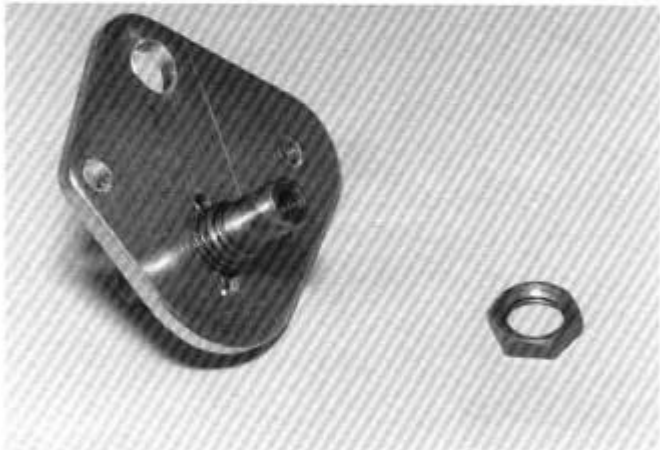

FIG. 32

FIG. 34—Take the idle gear pivot #6610 and gently tap it all the way into the aluminum plate, again making sure that the flange touches all the way around.

FIG. 35—Make sure the pin seats flush.

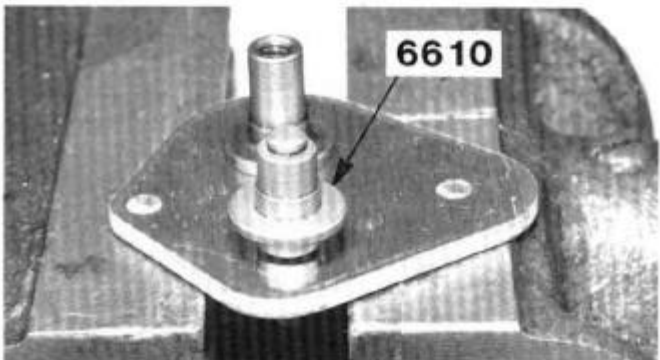

FIG. 34

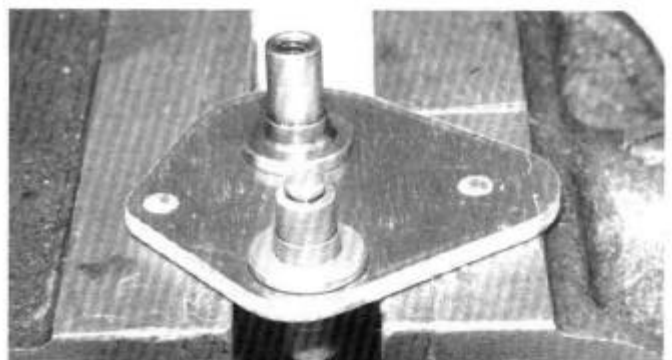

FIG. 35

□ **FIG. 36**—Turn the plate over and take the flat steel washer and slip it over the pivot as shown by the arrow.

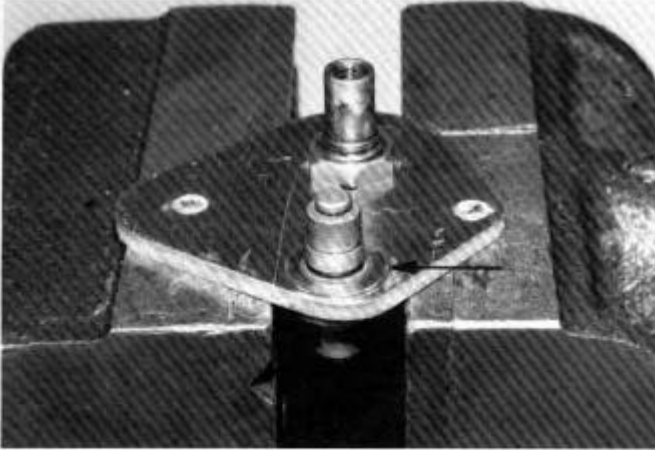

FIG. 36

□ **FIG. 38**—Install the clip all the way on. Make sure it is fully seated.

□ **FIG. 39**—Associated makes a complete ball bearing package for the RC10 Graphite: #6900. We'll show you how to install the bushings, which come with the kit, and the ball bearings. They're both installed in almost the same

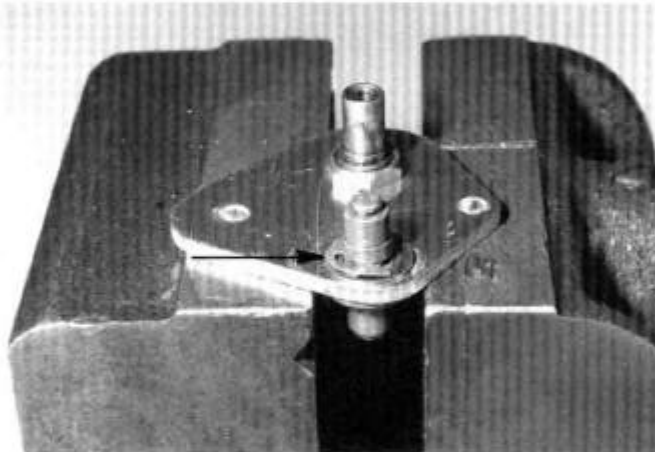

FIG. 38

□ **FIG. 40**—If you have the ball bearing kit, drop in the small unflanged bearing #6901 first and then the flanged bearing #6902.

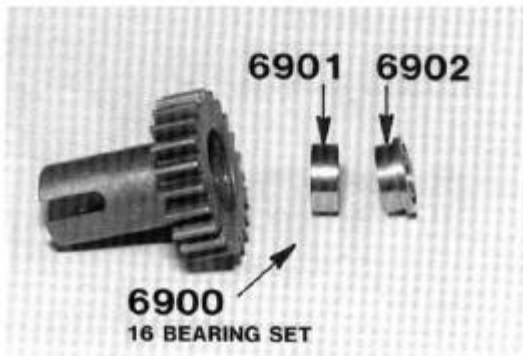

FIG. 40

□ **FIG. 37**—Install the large, curved E-clip as shown, with the center up and the ends down.

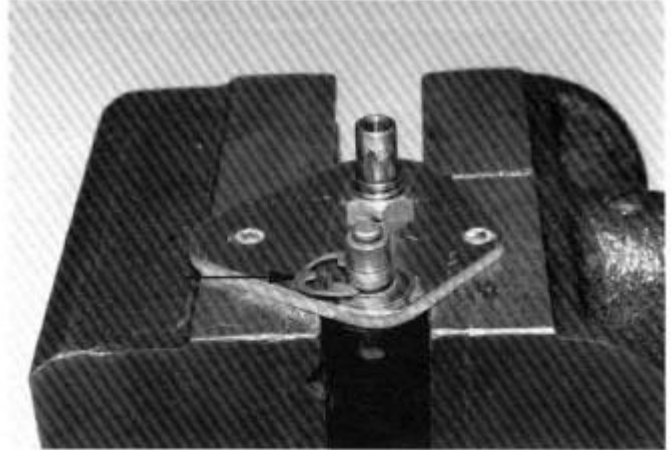

FIG. 37

manner. If you are using bushings, then wipe off the bushings and tap them into the two axle drive gears #6612. They are a snug fit, so it will be necessary to tap them in with a soft blunt object such as a wood dowel. Make sure they are seated all the way in so that the snap ring groove in the gear is exposed.

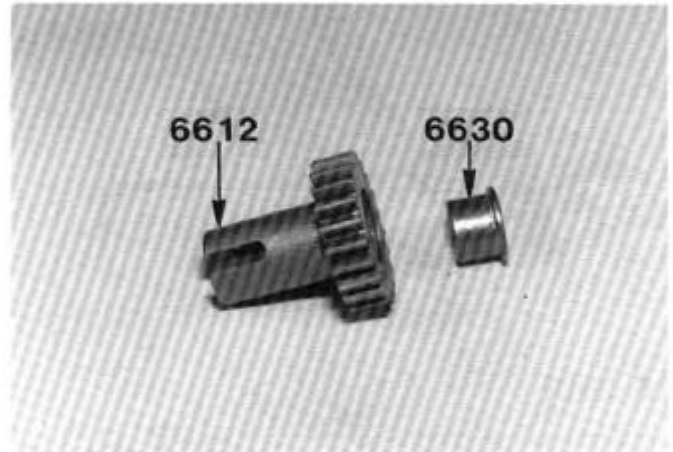

FIG. 39

□ **FIGS. 41 & 42**—Whether you have bushings or ball bearings, now install the C-clip to hold them in.



FIG. 41



FIG. 42

FIGS. 43 & 44—Make sure the C-clip is fully seated in the groove to hold in your bushings or ball bearings.

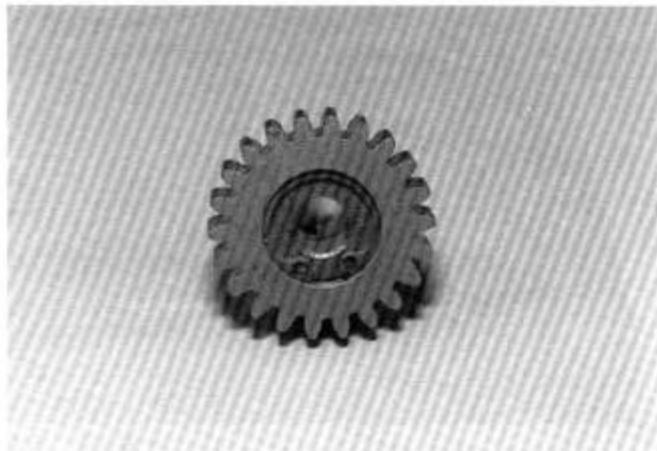

FIG. 43

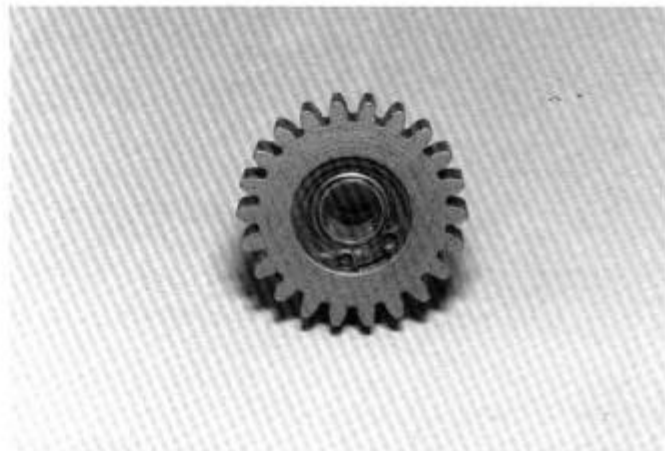

FIG. 44

FIG. 45—If you have bushings, take the aluminum plate and put a little oil on the bushing in one of the gears #6612 and bolt it onto the pivot #6609 using one of the button head screws as shown. Ball bearings will not require oiling. Turn the plate over and oil and bolt the other gear.

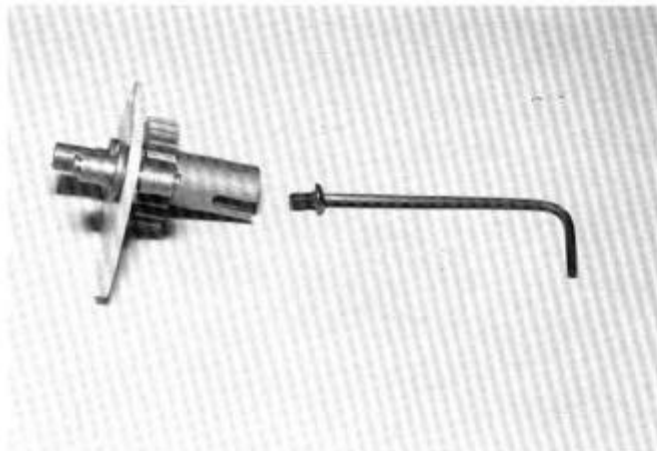

FIG. 45

FIGS. 46 & 47—Take the two plastic gears #6614 out, and two of the ball bearings (Fig. 46), or two of the short, small bushings (Fig. 47).

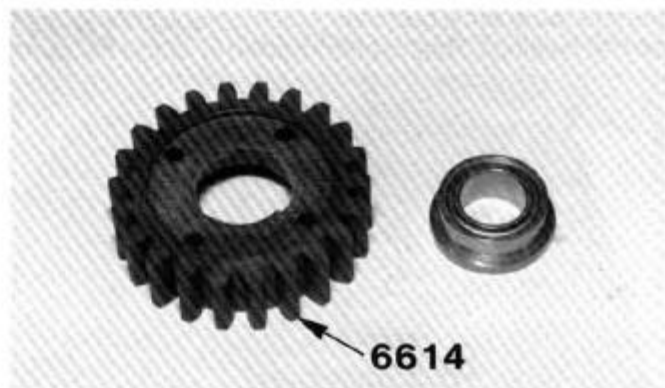

FIG. 46

FIG. 48—With the flange of the bushing or ball bearing down flat against the table, hold the gear flat as shown and push it down with your thumbs onto the bearing.

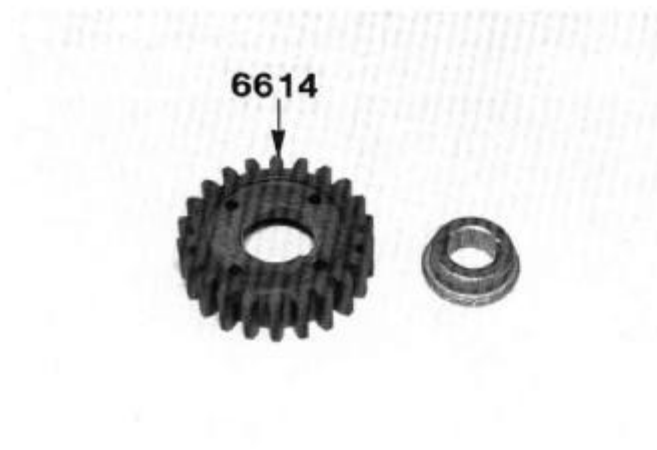

FIG. 47 page 12

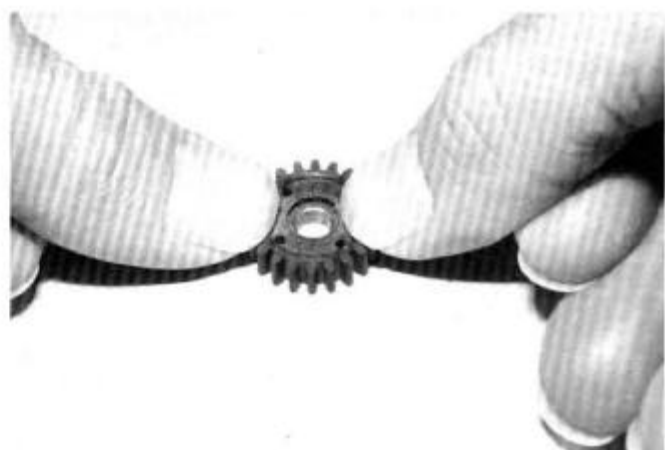

FIG. 48

FIG. 49 & 50—Screw in the four small button head screws as shown. Tighten the screws only until they seat. Do not overtighten. Be careful because the screws are

very small. (If the wrench starts to slip, it can be sharpened by cutting a small amount off the end with an abrasive cut-off wheel or grinding stone.)



FIG. 49



FIG. 50

FIG. 51—The completed gear.

and put it on the bottom screw as shown. Now rotate the gear and put it on the second screw, which will now be in the bottom position. If you get too much ZAP on while rotating the gears this way, it will run down away from the bearing and not on the bearing. Lock all four screws this way, on both gears.

FIG. 52—To lock the screws in, we recommend the use of pink ZAP, a cyanoacrylate adhesive. Put a VERY, VERY SMALL amount of ZAP on the end of an X-acto blade



FIG. 51

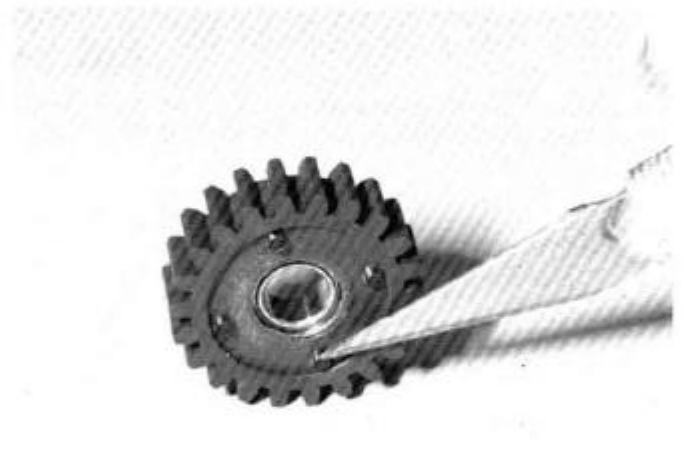

FIG. 52

FIG. 53—Now oil the bushing and put the completed gear on the pivot pin of the aluminum spine plate.

FIG. 54—Oil and put the second gear on and install E-clips on both.



FIG. 53

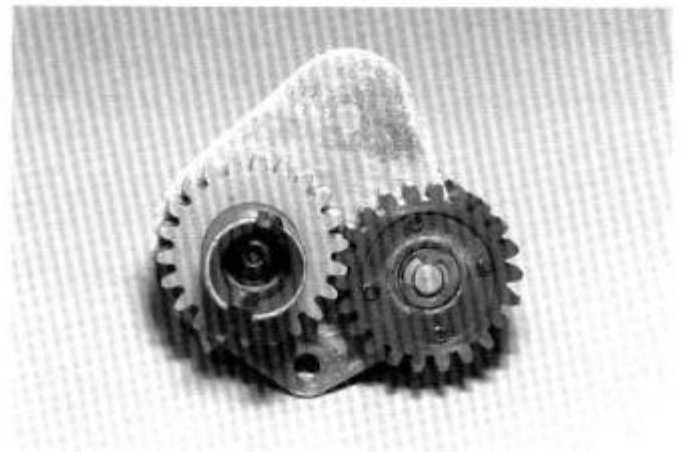

FIG. 54

FIG. 55—Rotate both left hand and right hand gear sets. They should both rotate very freely. If they do not rotate freely, you may have forgotten the washer, as shown by the arrow, which will cock the shaft, not allowing the flange to seat flush. (Those flanges **MUST** be flush and even against the plate!) Or you may have to try lifting and rotating the plastic gear a few teeth before remeshing, then you may find a position where they are the smoothest.

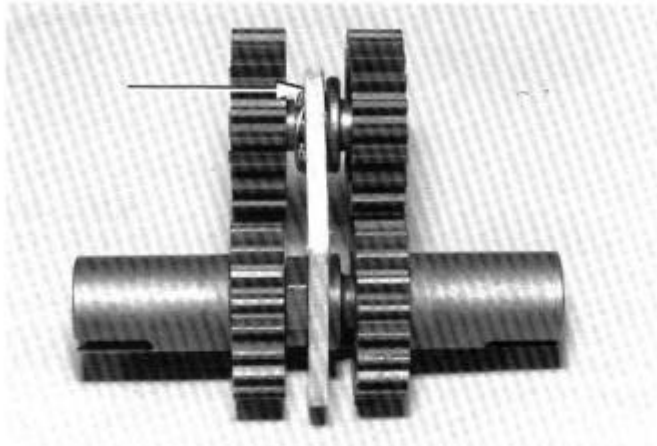

FIG. 55

FIG. 57—Slip the washer on the shaft. Slip the blue thrust bearing on, as shown. Now set this shaft aside until we come to Fig. #67.



FIG. 57

FIG. 59—Push the bushing or ball bearing all the way into the adaptor as shown.



FIG. 59

FIG. 56—Now take the differential shaft with gear #6618, and the thick thrust washer with the small hole from the same small bag. The gear is locked to the shaft on a taper. If the gear has come loose, you can reseal it by supporting the gear on the top of a vise and giving the big end of the shaft a sharp rap with the **WOODEN** handle of a hammer.

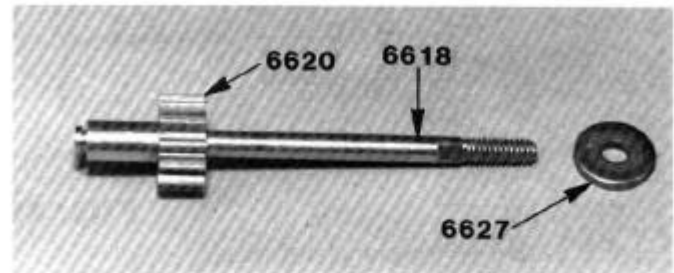

FIG. 56

FIG. 58—Take one of the bearing adaptors #6606 out of Bag #6-12 and one of the narrow bushings with a 1/4" dia bore, or your ball bearing.

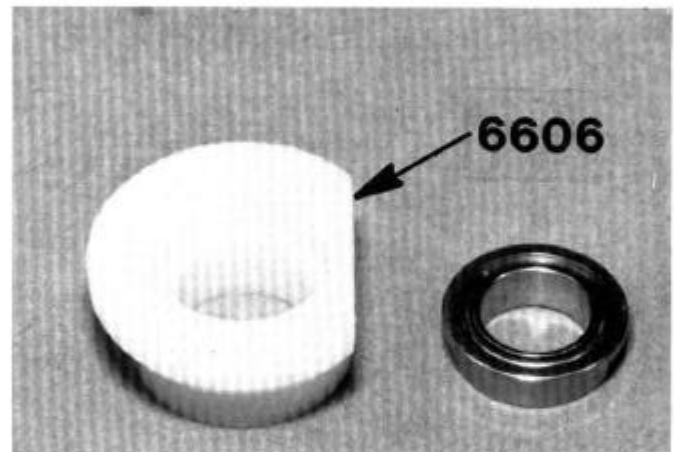

FIG. 58

FIG. 60—Take the dif tube #6617 out of the Bag.

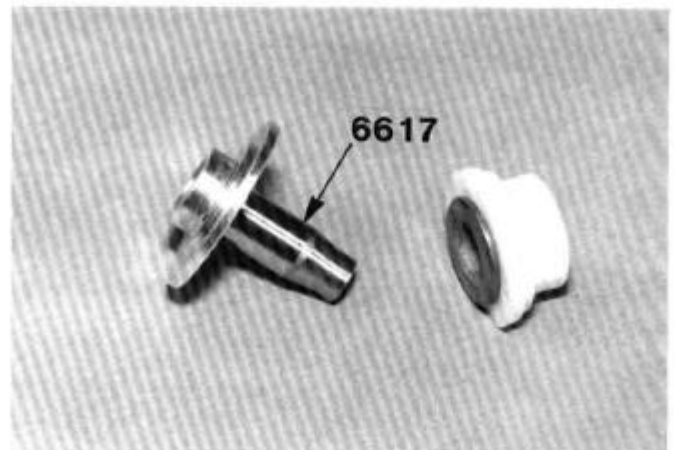

FIG. 60

FIG. 61—Oil the bushing and slip it on the dif tube, as shown.

FIGS. 62 & 63—Take the gear #6621 and slip the gear onto the tube and tap the assembly together using

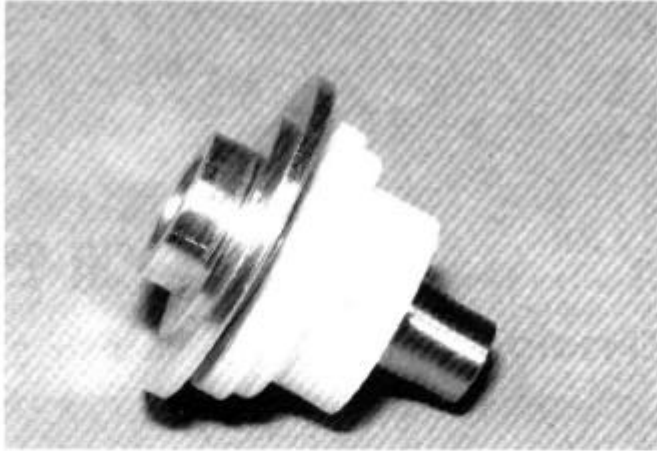

FIG. 61

the plastic handle of a screwdriver. DO NOT use a vise to squeeze it on. The gear does NOT go all the way on. There should be enough room left in the gear (.100" or 2.5 mm) (see Fig. 62) to install the Teflon bushing shown in Fig. 66.

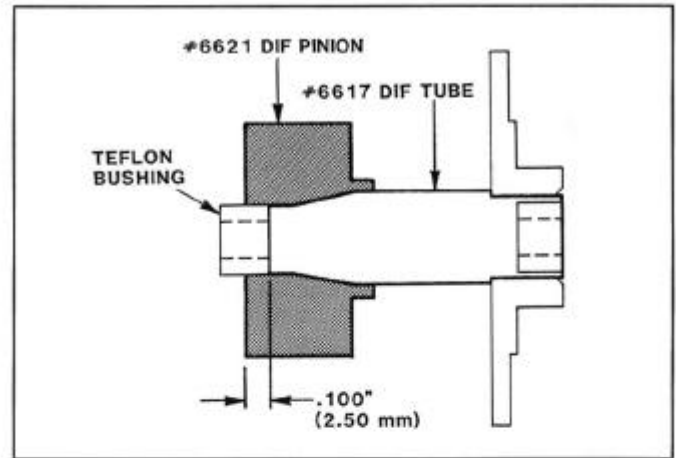

FIG. 62

FIG. 64—Take one of the small white Teflon bushings #6623 out.

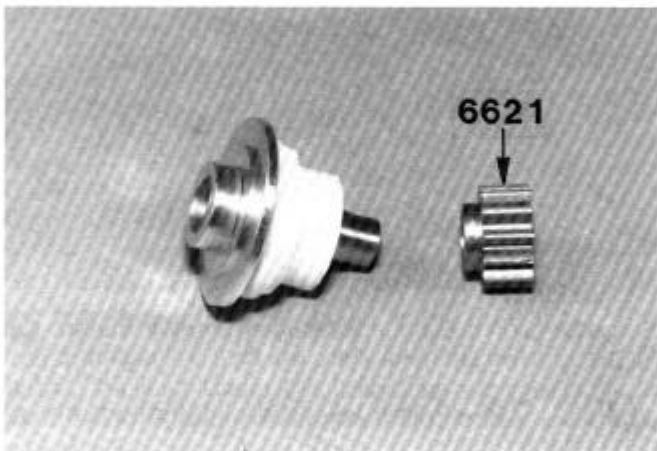

FIG. 63

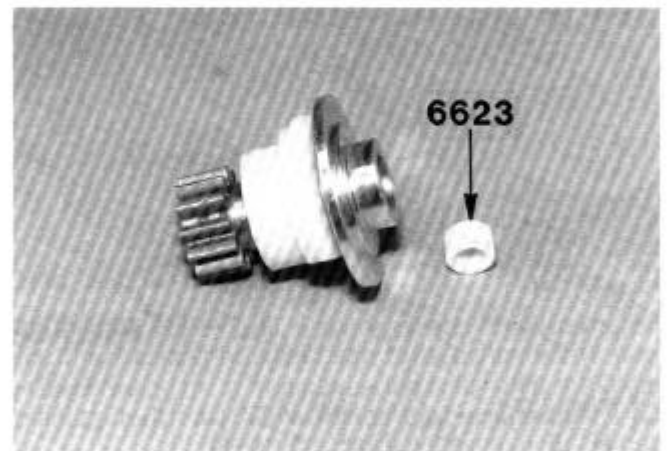

FIG. 64

FIG. 65—You should be able to push the bushing into the tube with your finger.

FIG. 66—Now take the other bushing #6623 and

the other thick thrust washer out. Push the bushing inside the washer. Push the bushing into the dif tube. The bushing should be inside the dif tube with the washer on the outside of the bushing.



FIG. 65

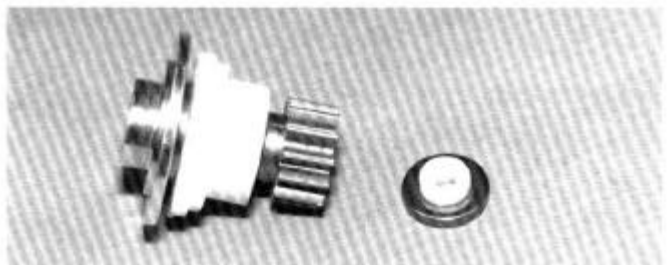

FIG. 66

FIG. 67—Now slip the dif tube assembly onto the shaft, as shown.

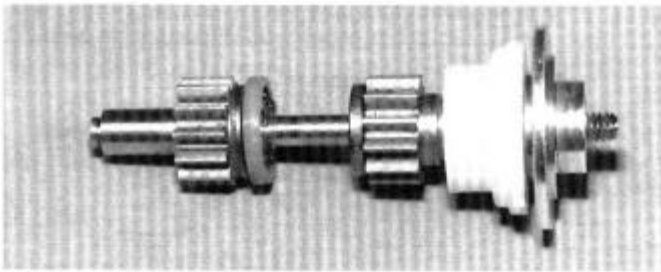

FIG. 67

FIG. 68—The dif tube assembly should spin freely on the dif shaft. If not, the Teflon bushings might not be centered correctly. Check this, and use the shaft to help center the bushings.

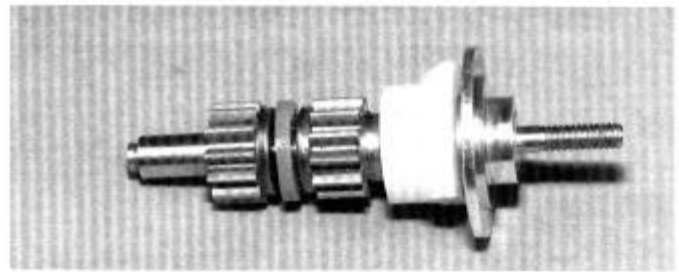

FIG. 68

FIG. 69—Take one of the dif drive rings #6625 out of the Bag.

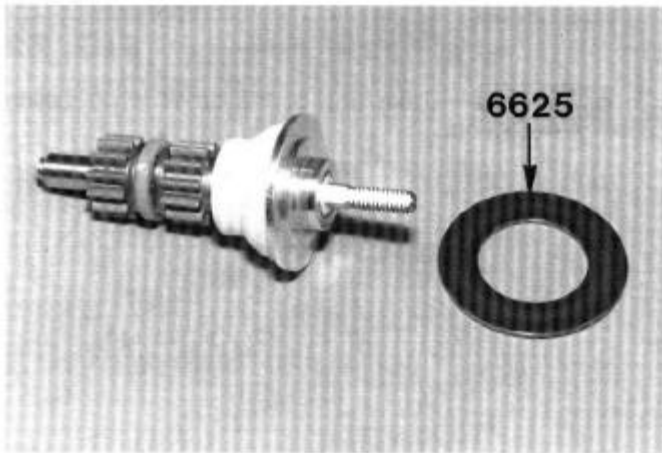

FIG. 69

FIG. 70—Slip the ring on the hub, as shown.

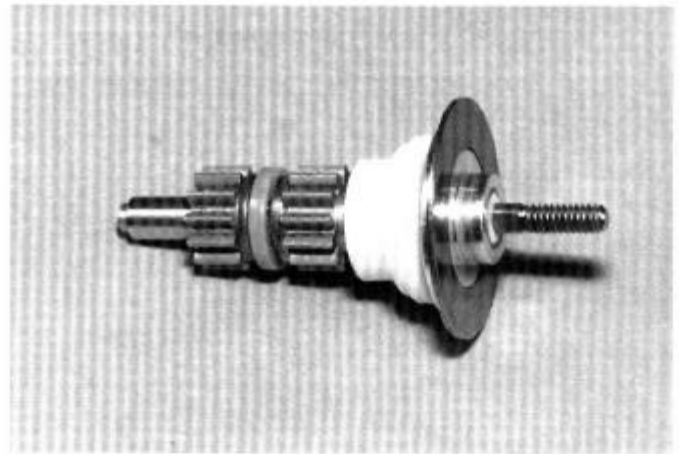

FIG. 70

FIG. 71—Take the balls #6626 out of the bag. From Bag #6-15, remove the plastic spur gear.

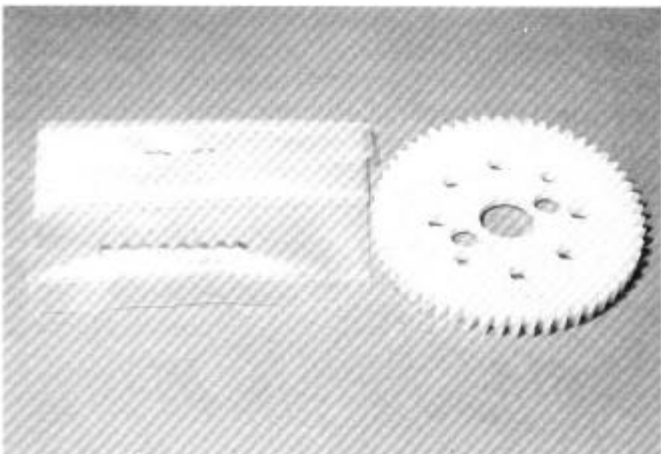

FIG. 71

FIG. 72—Push the eight balls into the square holes in the gear as shown.

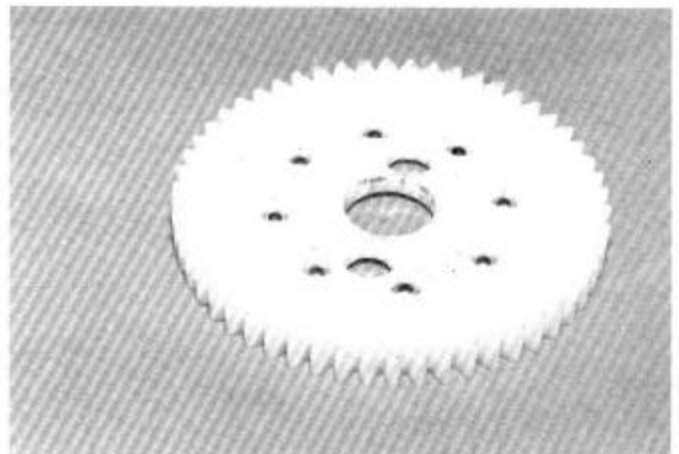

FIG. 72

FIG. 73—Take the #6636 Associated dif lube.

FIG. 74—Apply a small amount of the Associated dif lube #6636 to the center hole of the gear. DO NOT use this

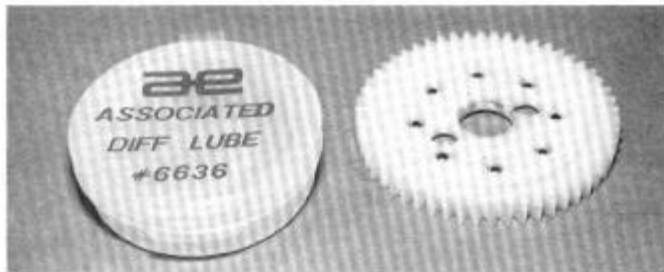

FIG. 73

FIG. 75—Apply a small amount of this special lube to the balls on both sides of the gear. NEVER use any other type of lube on the balls, otherwise the dif will slip.

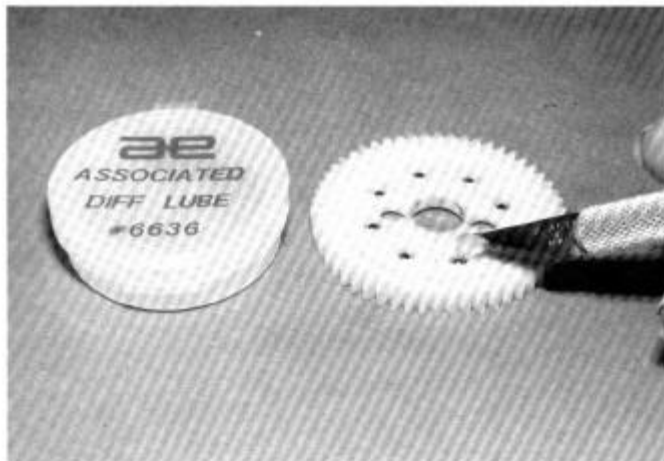

FIG. 75

FIG. 77—The outer dif hub has a notched hole to match the flat spots on the shaft. Align the two and slip the hub on the shaft. Check that both drive rings are centered and seated against the aluminum hubs. Take out the dif spring #6628 and nut.

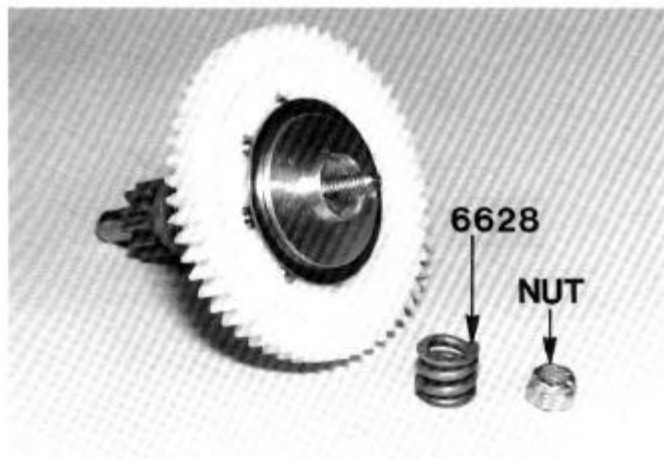

FIG. 77

dif lube anywhere else on the car for metal to metal lubrication. (It's intended as a plastic to metal or plastic to plastic lubricant.)

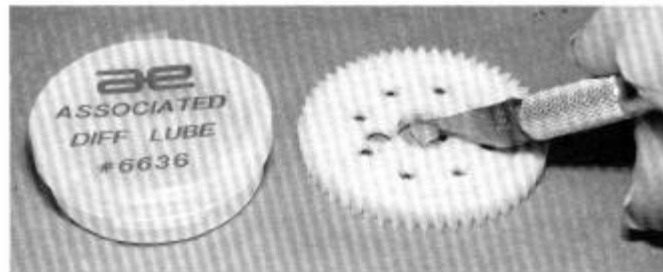

FIG. 74

FIG. 76—Take the dif shaft assembly and spur gear. Slip the spur gear on the shaft. Take the other drive ring. Slip the drive ring on the shaft and take the dif outer hub #6624.

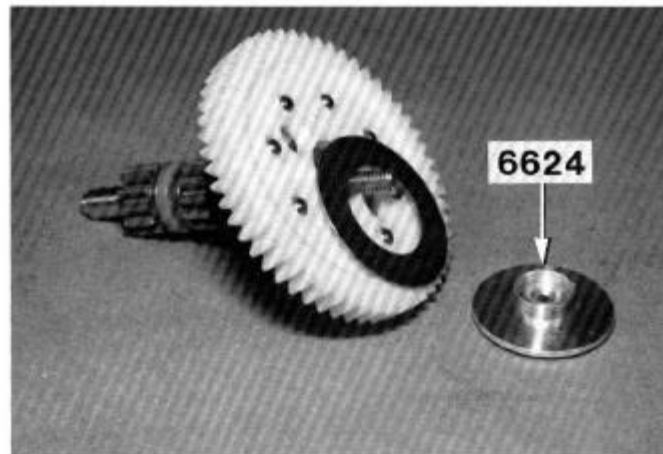

FIG. 76

FIG. 78—Slip the spring on and screw the nut on. You'll have to hold the small gears to keep them from turning while screwing the nut on. Screw the nut on until the end of the nut is even with the end of the shaft, as indicated.

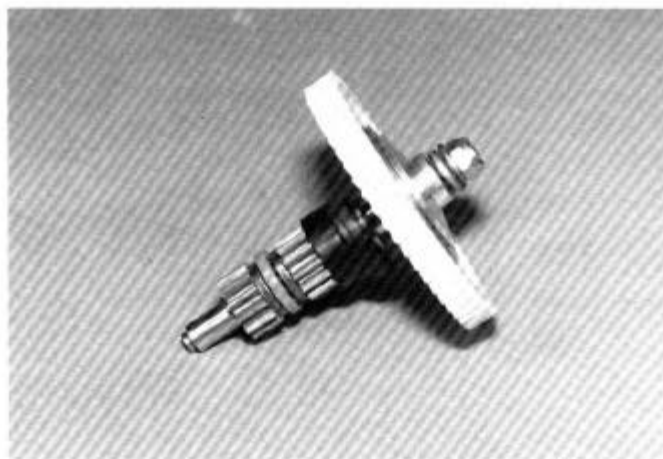

FIG. 78

FIG. 79—Hold the dif assembly in your hands as shown. Hold the outside small gear still and slowly rotate the big plastic spur gear. The inside small gear should rotate, and the whole rotation should be very smooth. Then the dif is working correctly. Now hold both small gears tightly in your



FIG. 79

FIG. 81—Slip the dif into the motor mount.

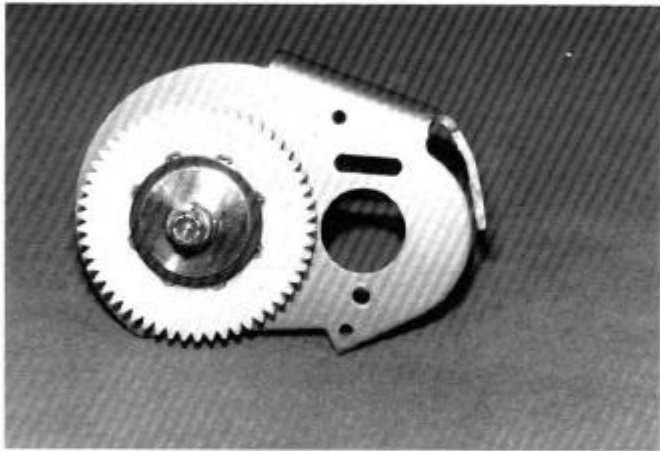

FIG. 81

FIG. 83—Slip the right hand half of the housing onto the dif.

Note: there is a flat on the adaptor that **MUST** match a flat in **BOTH** the motor mounting plate and the transmission case. The adaptor is a tight fit in the transmission case, so you'll have to work to get it started. If you have installed it

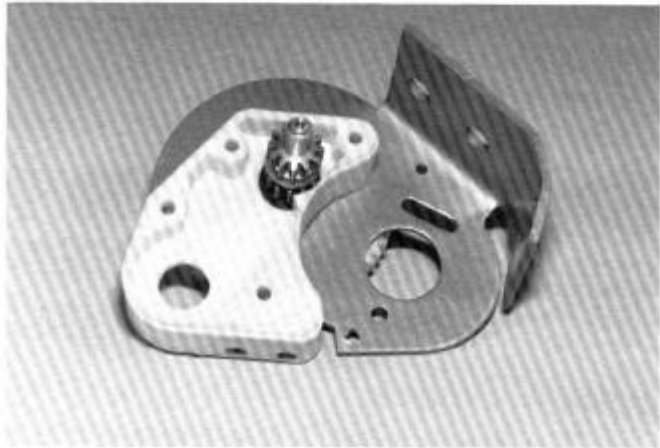

FIG. 83

fingers and try to turn the big plastic gear. It should be **VERY HARD** to turn.

FIG. 80—Take the motor mount #6607 out.

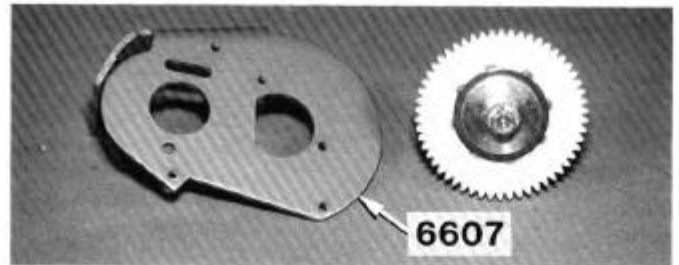

FIG. 80

FIG. 82—Make sure the bearing adaptor is properly seated in the motor mount. Now take out the transmission housing #6605.

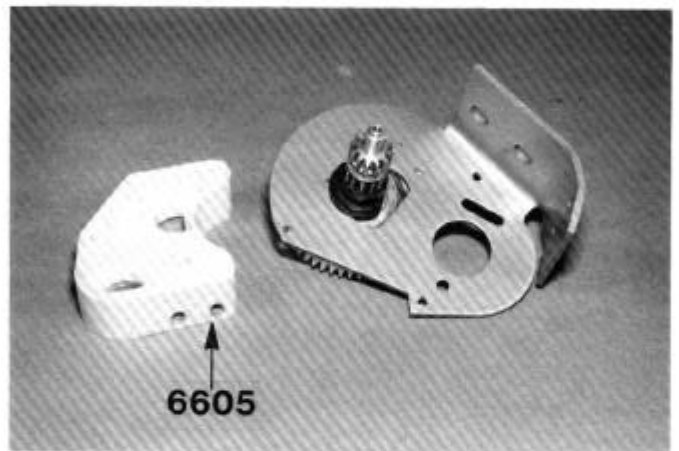

FIG. 82

properly, the adaptor will be in far enough to be flush on the inside of the case half-shell. The motor plate will be loose for the next nine steps.

FIG. 84—Take the idler gear assembly.

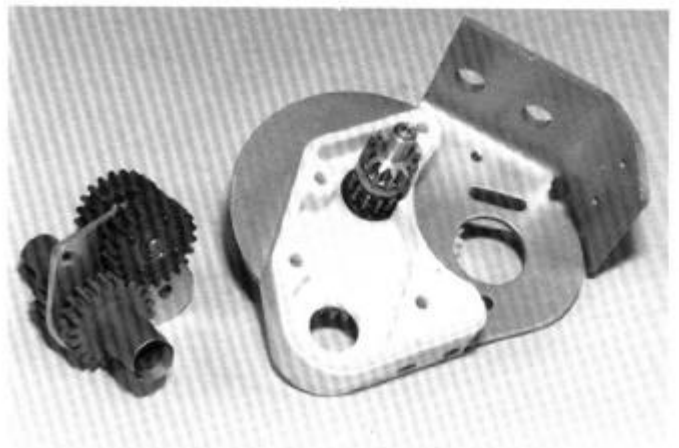

FIG. 84

FIG. 85—Set the idler gear assembly into the housing, as shown.

FIG. 86—Take the other bearing adaptor and cut a small notch in the edge, as shown. This will make installing and removing the E-clip a lot easier. Push the bushing or ball bearing into the adaptor.

FIG. 87—Take the left hand side of the housing and push it onto the right hand side. It will snap together with finger pressure.

Note: the seam between the two halves of the case should close completely with no more than a few thousandths of an inch gap showing (usually on the bottom of the case). If you cannot close the case completely, look for something blocking inside.

Push the adaptor onto the dif shaft. Take the three long Allen screws, as shown, and screw them into the motor mount, but only part way.

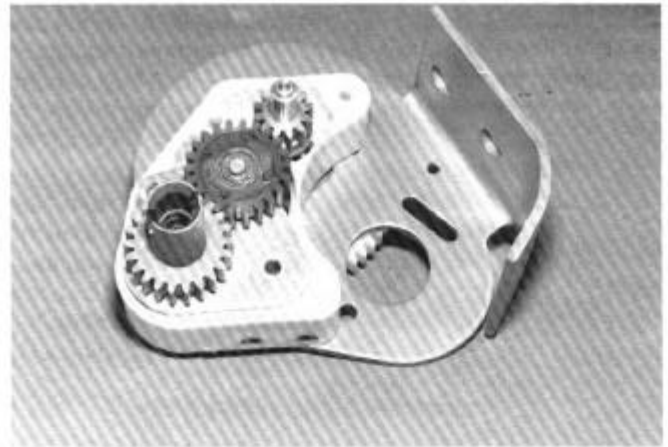

FIG. 85

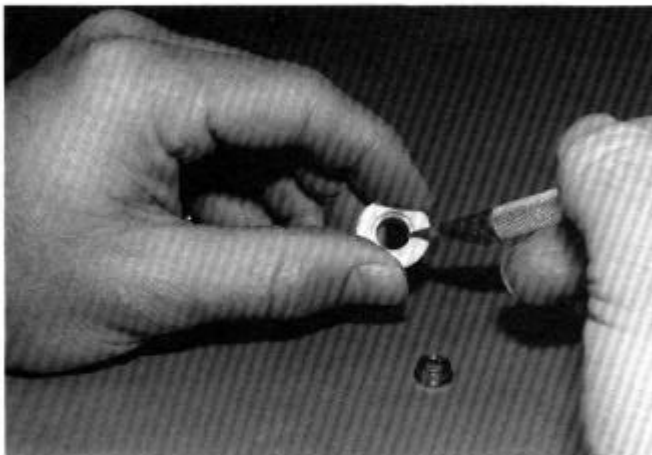

FIG. 86

FIG. 88—Take the two felt seals #6633 and slip them on the hubs, as shown, one on each hub. Now push the two felt retainers on. They should snap in. The "ears" should be horizontal. If they're loose, use a drop of contact cement to hold them in.

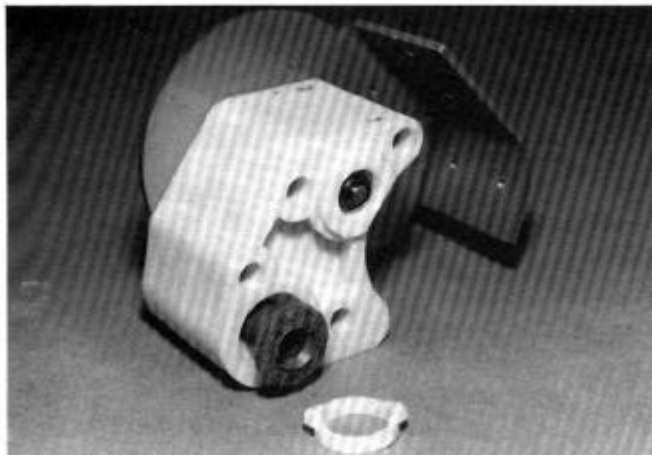

FIG. 88

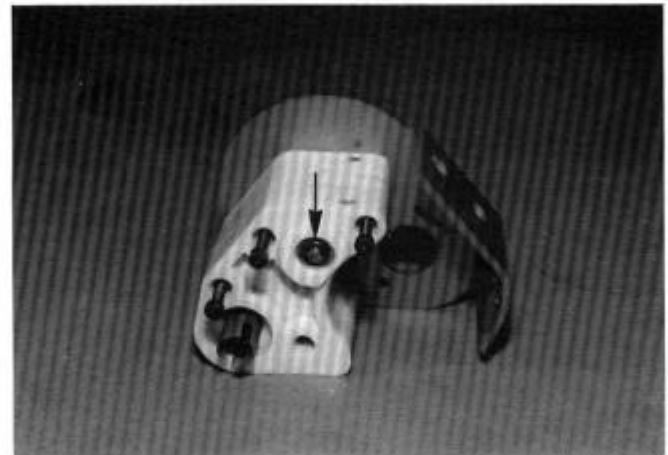

FIG. 87

FIG. 89—On the bottom of the transmission case, as shown, are two molding lugs. Cut these off flush with an X-acto knife.

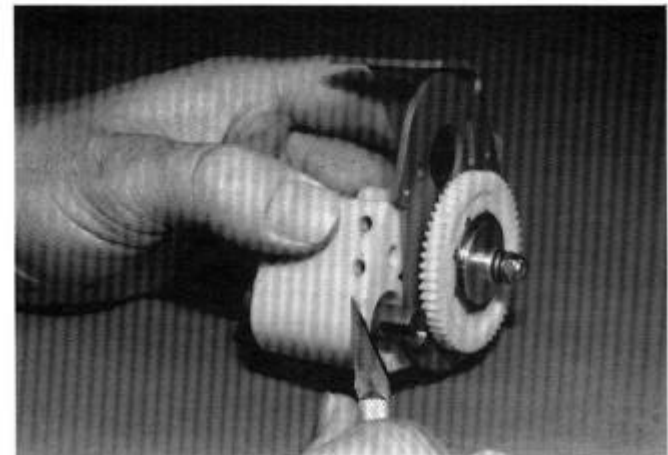

FIG. 89

FIG. 90 & 91—Take the other short screw, slip a 4/40 nut into the hex hole, as shown, and tighten this screw, then tighten the other three screws from Fig. 87. Now push the E-clip (as shown at the bottom of Fig. 91) onto the end of the dif shaft. Make sure it's fully seated.

Note: after assembling the transmission with bushings for the first time, the large gear may be hard to turn. You can free things up by giving a sharp blow to each END of the dif shaft using the plastic handle of a screwdriver as a hammer. A few raps on the adjustment nut followed by a few against the adaptor on the other side will help to align the bushings. Once you start running the car, the bushings will free up completely.

FIG. 92—Take a piece of servo tape, cut it round as outlined, and stick it to the transmission case to seal the dif bearing.

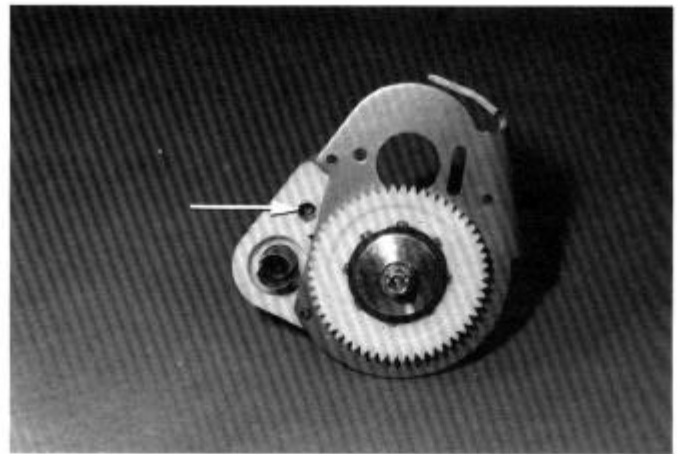

FIG. 90

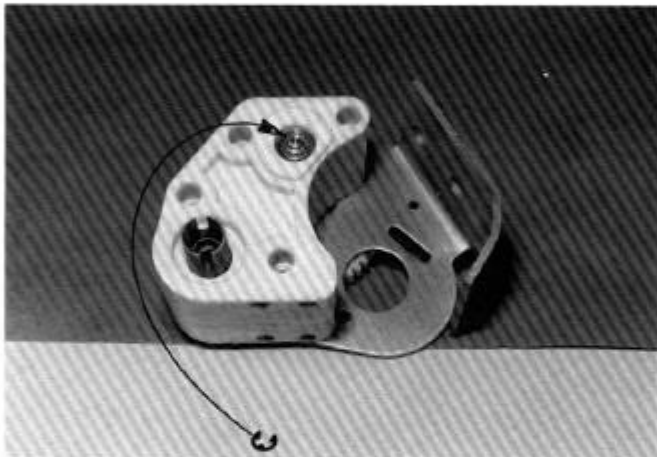

FIG. 91

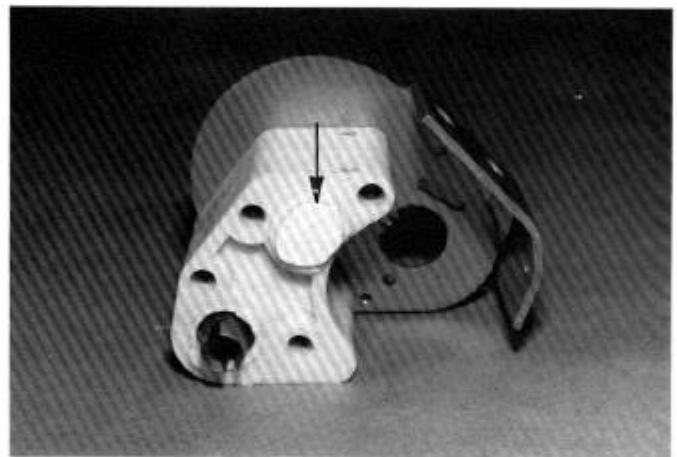

FIG. 92

FIG. 93—Take the bulkhead #6323 and screws shown out of Bag #6-4 and screw on two of the long ball ends in the location shown. Take the two wing tubes and round off the square-cut corners of the ends with a file, and tap the wing tubes into the bulkhead, as shown in Fig. 94.

FIG. 94—Mount the bulkhead to the chassis, as shown, but DO NOT tighten the two screws all the way down yet.

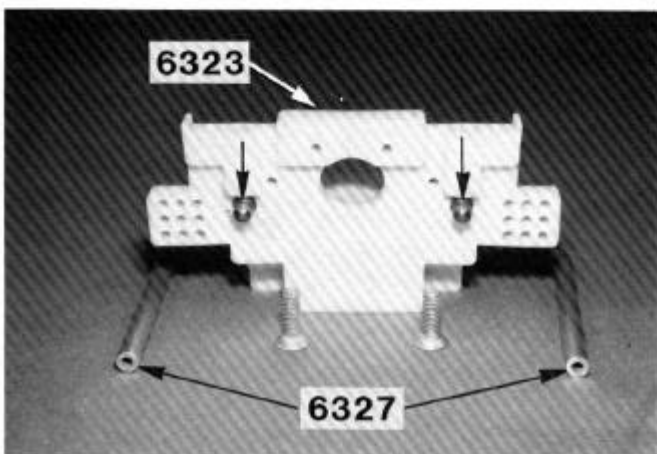

FIG. 93

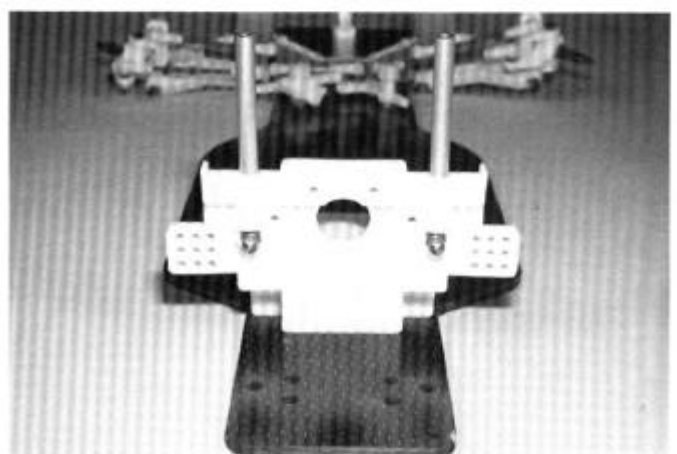

FIG. 94

FIG. 95—Mount the transmission to the chassis, as shown, with the four aluminum screws, but DO NOT tighten the screws all the way down yet.

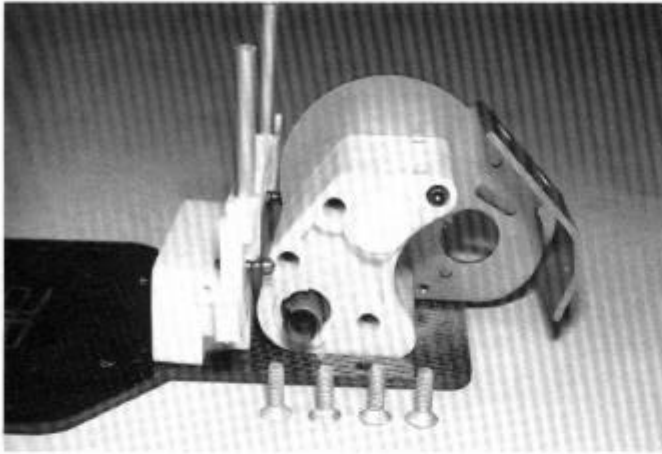

FIG. 95

FIG. 97—Screw on the rear body post to the transmission brace #6325 as shown.

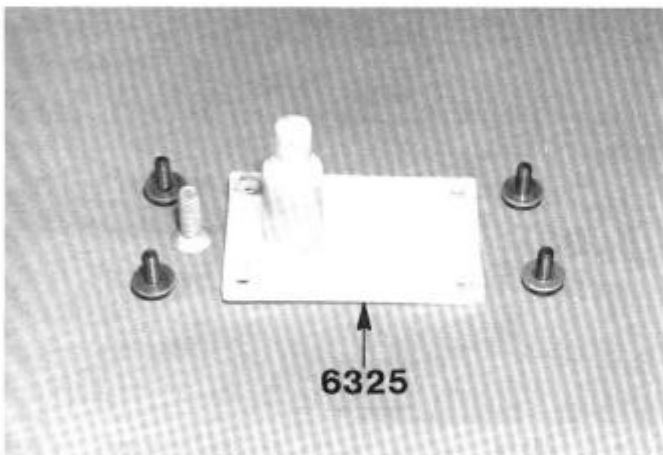

FIG. 97

FIG. 99—Take the rear suspension mount #6360 out of Bag #6-8 (with the letter "L" on the bottom), the left hand rear A-arm #6355 and the inner hinge pin #6380. Line up the holes in the arm and mount and push the pin through. The arm should be able to swing freely on the pin, but the pin should be tight in the mount. Install the two E-clips.

Note: the left and right rear mounts are connected together by a thin "runner" that should be removed with scissors.

FIG. 96—All six of these screws should be a little loose still.

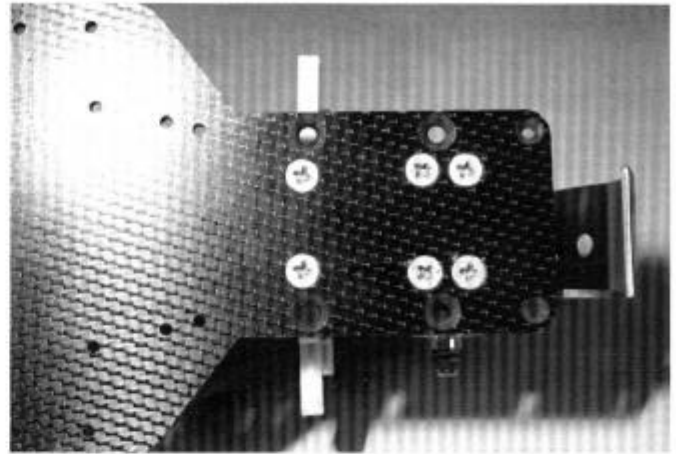

FIG. 96

FIG. 98—Mount the transmission brace to the transmission and to the bulkhead as shown and tighten the four screws. NOW TIGHTEN the six screws shown in Fig. 96. DO NOT OVERTIGHTEN.

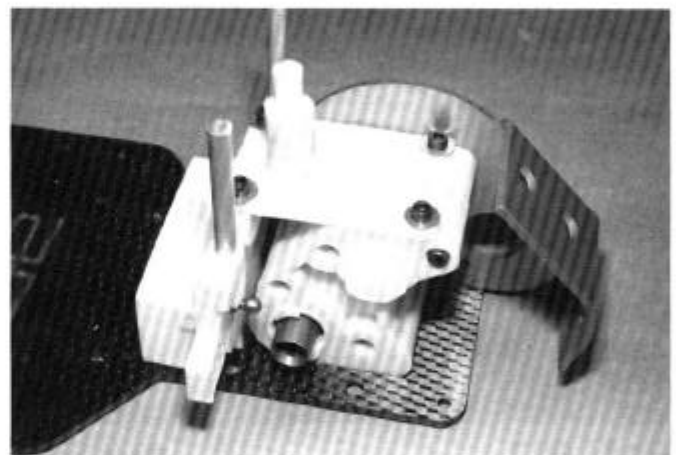

FIG. 98

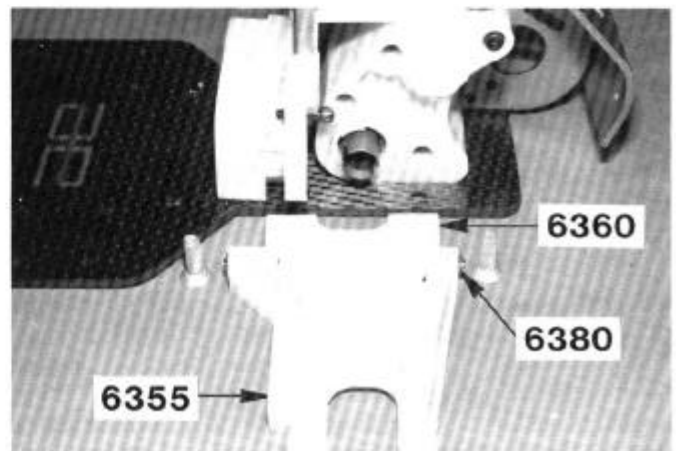

FIG. 99

FIG. 100—Bolt the left hand mount to the chassis with the two aluminum screws. Now bolt the right hand mount.



FIG. 100

FIG. 101—The bottom of your chassis should now look like this.

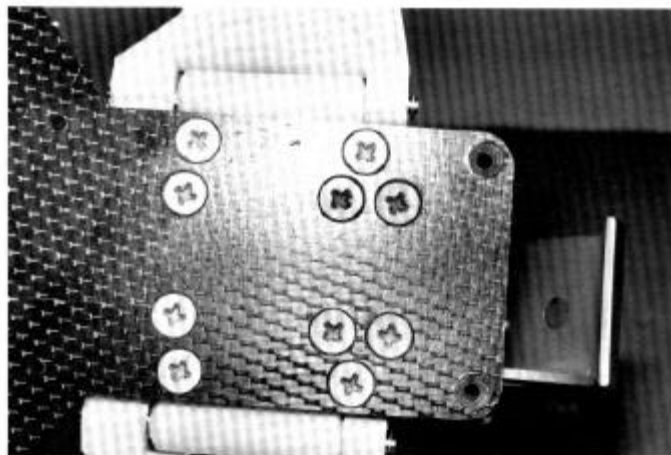

FIG. 101

FIG. 102—Take the left hand hub carrier #6366, the one that has the letter "L" on it, and push the two ball bearings #897 in it.

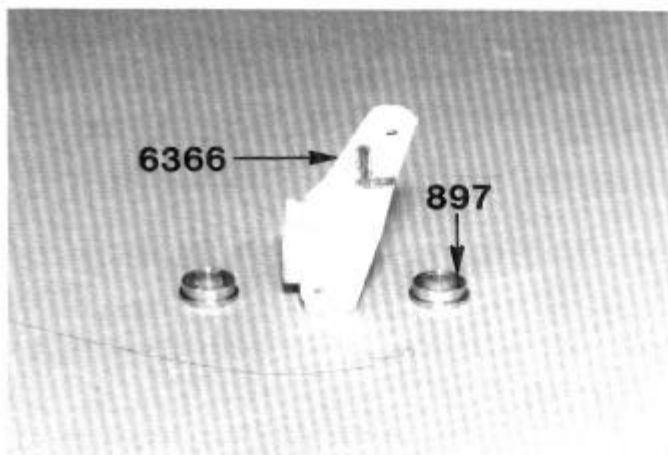

FIG. 102

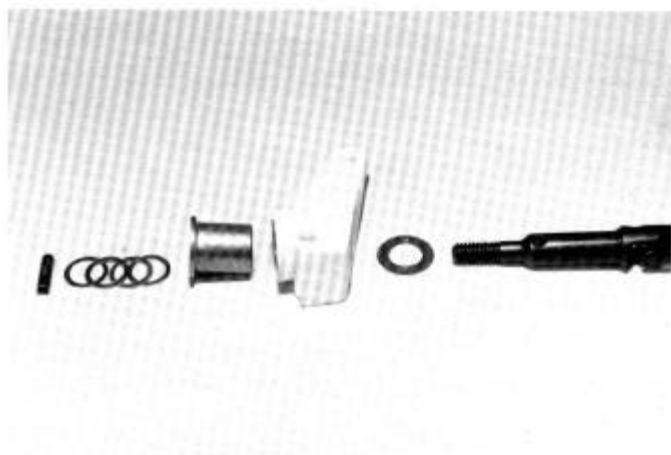

FIG. 103

FIG. 103—If you have bushings, the parts must be installed in this order: push the bushing in the outside of the hub carrier as shown and oil the bushing. Slip the large washer onto the drive shaft and then slip the driveshaft into the bushing. Now slip up to four of the small washers on the axle so you end up with just a small amount of end play between the washers and the roll pin. Install the roll pin—a small pliers will help here. Now check and make sure you have a small amount of end play. Do the right hand side.

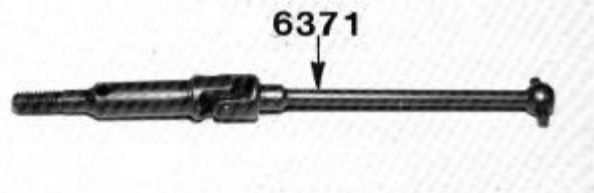

FIG. 104

FIGS. 104 & 105—Take the universal dogbone driveshaft #6371 and slip it into the ball bearings. Then slip on four of the thin washers and then insert the roll pin into the hole in the axle. A pliers will help here. There should be just a very small amount of side play when you're done. If it's too loose, add another washer; if it's too tight, take a washer out. Now do the right hand side.



FIG. 105

FIG. 106—The big arrow is pointing to the roll pin which must be centered in the axle or you will have trouble getting your wheels on. Now attach the hub carrier to the A-arm by the pin #6381. Put on the two E-clips. Do the right hand side.

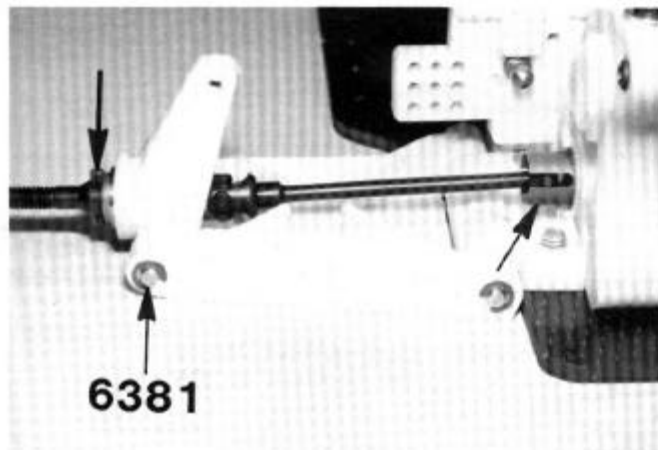

FIG. 106

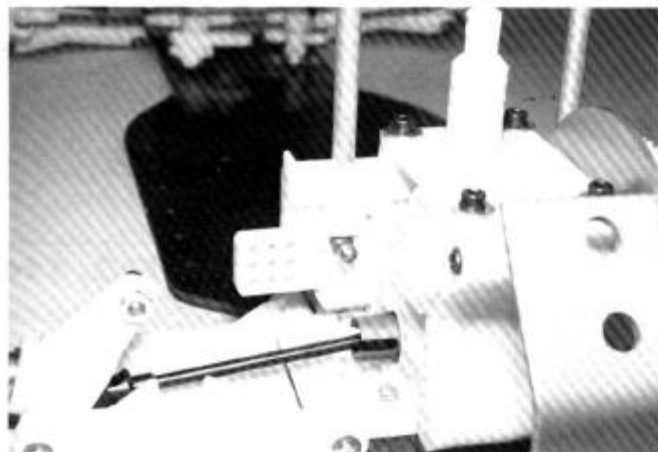

FIG. 108

FIG. 107 & 108—Screw on a long 4/40 ball end and nut, where shown, and do the right hand side.

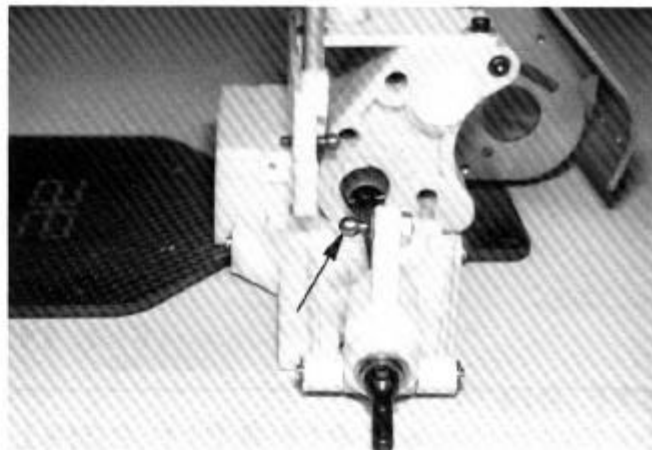

FIG. 107

FIG. 109—Take the last two turnbuckles and screw the plastic ball cups on so the distance from the centerline of the ball cups is 2.00" (50.80 mm). Now pop the rods onto the balls.

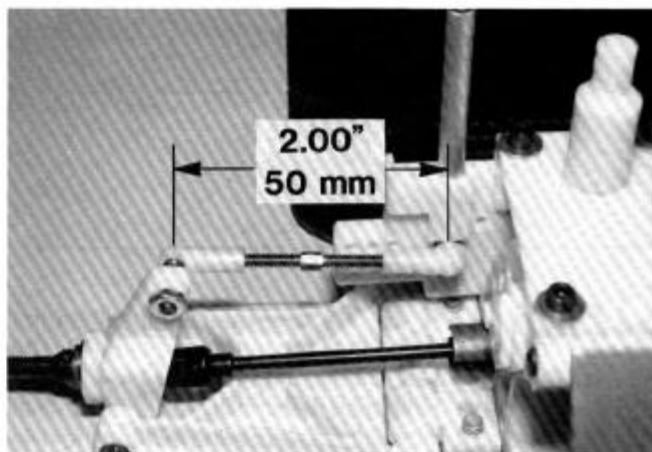

FIG. 109

SHOCKS

FIG. 110—Time to build the shocks. We'll start with the rear shocks from Bag #6-9, but since it's easier to do all

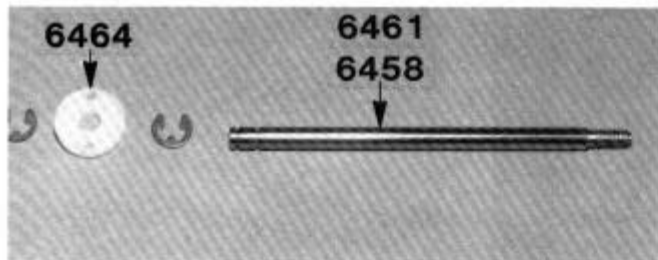

FIG. 110

four shocks at the same time, also use Bag #6-10. Take out the parts shown for all four shocks.

FIG. 111—Install one E-clip as shown. Make sure it's fully seated.

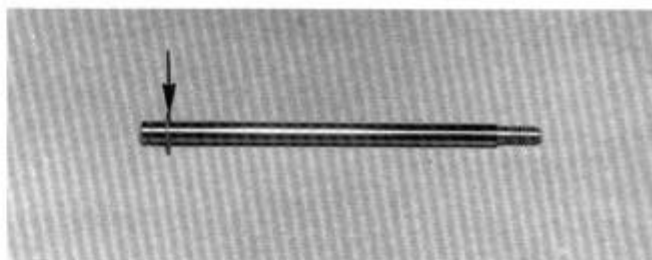

FIG. 111

☐ **FIG. 112**—Now slip on the piston #6464 and install the other E-clip.

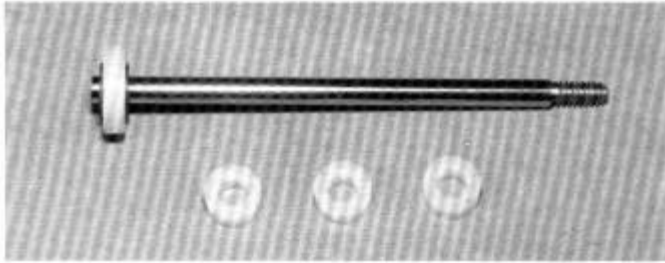

FIG. 112

☐ **FIG. 113**—In a separate bag will be six nylon spacers. Slip three of these onto each of the long shafts, all the way up to the piston. These spacers are not used on the front shocks.

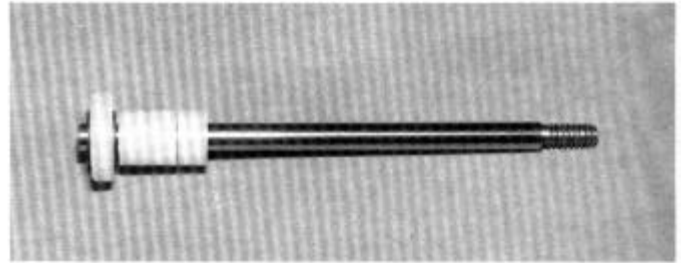

FIG. 113

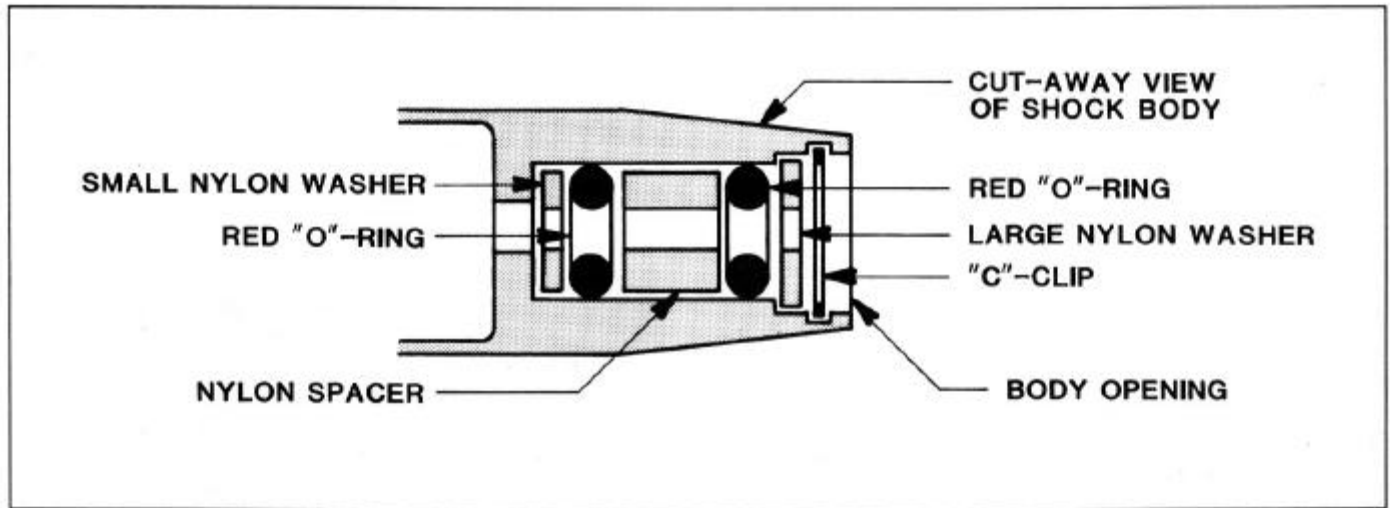

FIG. 114

☐ **FIGS. 114 & 115**—Take out the short front shock bodies #6449 and the long rear bodies #6446. Then take out the O-ring washer bags. Fig. 114 and 115 show how to install the parts. First push the small nylon washer all the way to the bottom. Then slide a red O-ring in, then the nylon spacer, another O-ring and then a large nylon washer.

☐ **FIG. 116**—Install the C-clip snap ring so that it is fully seated, as shown. If it is not seated correctly the shock will come apart. A small screwdriver is handy here.

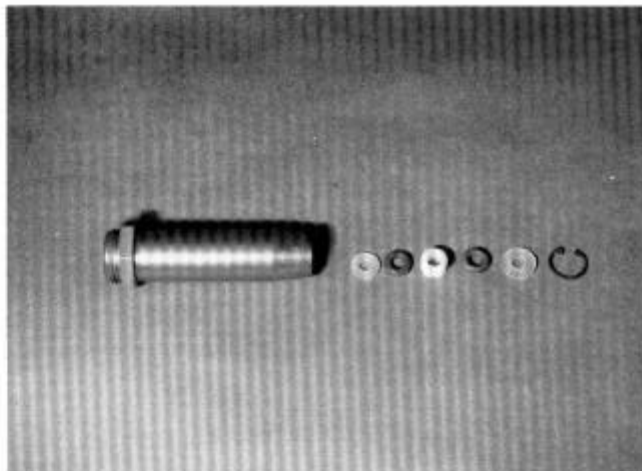

FIG. 115

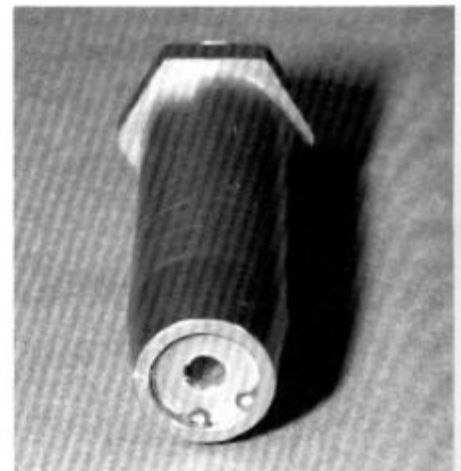

FIG. 116

❑ **FIGS. 117 & 117A**—Your kit comes with the highest grade synthetic shock oil available. However, Associated also has available a better racing silicone shock oil (Fig. 117A) used by the Team. If you're planning on using the silicone oil, it's better to use the silicone oil first instead of using the synthetic oil:

STEP 1—Put five or six drops of oil into the open shock body first. This is to lubricate the O-rings.

STEP 2—Lightly oil the shock shaft. Now put the shaft into the shock body from the top, and very carefully and slowly push the threaded end of the shaft through the O-rings. We don't want to cut the O-rings. Pull the shaft all the way through to the bottom.

STEP 3—Hold the shock upright as shown and fill with oil. Fill the front shocks all the way to the top and the rear shocks within 1/32" of the top.



FIG. 117A

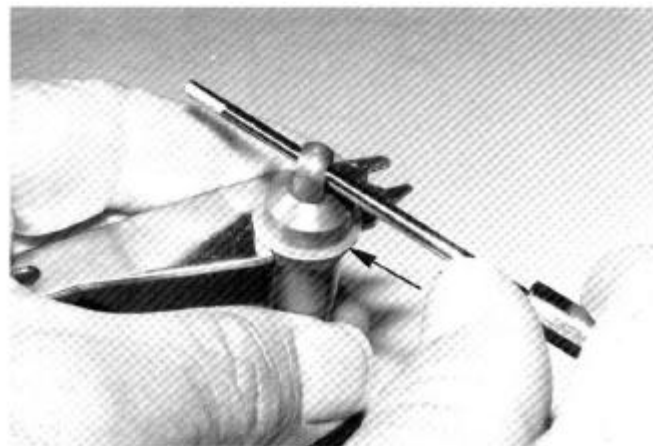

FIG. 119



FIG. 117

❑ **FIGS. 118 & 119**—Take the cap #6463 and the nylon gasket that the big arrow is pointing to in both pictures. Put the gasket over the threaded end of the shock body and screw on the cap. Now tighten down the cap as shown just enough to seal, but do not overtighten.

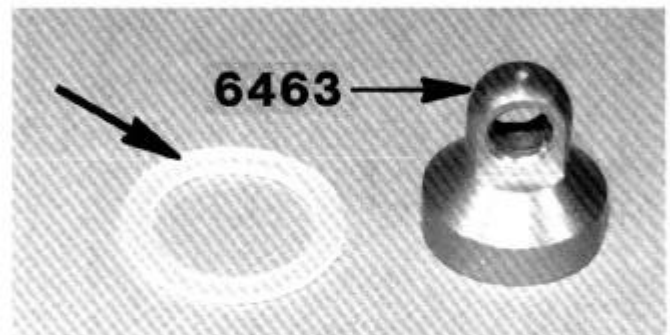

FIG. 118

❑ **FIG. 120**—From Bag #6-11 remove the parts shown. Starting with the front shocks, slip on the spring clamp #6474 so the thin flange is toward the spring. Then slip on the gold spring #6497 and the spring retainer #6474. Pop the metal ball end into the plastic ball end with a pliers.

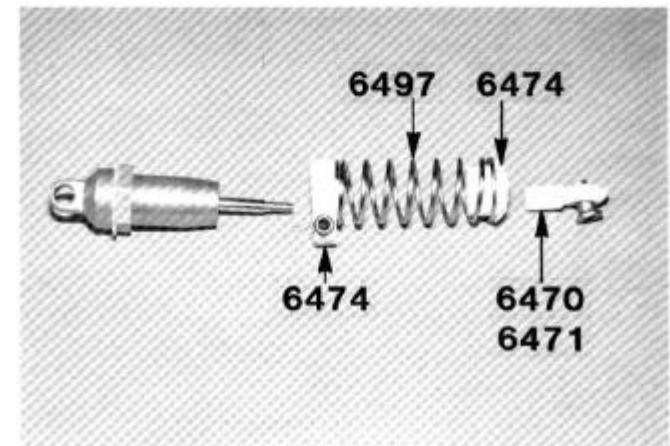

FIG. 120

FIG. 121—With a thin pliers, hold the shock shaft right next to the threads. If you hold the shaft anywhere else your shock will leak. Screw on the plastic end until it bottoms out. Put the silver springs on the rear shocks.

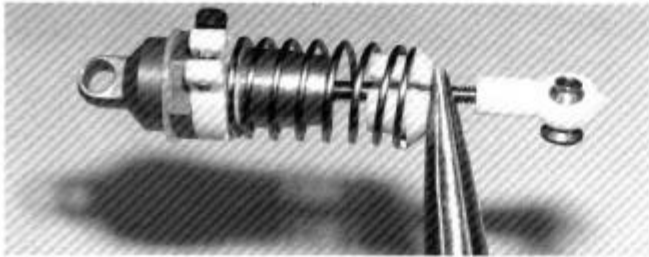

FIG. 121

FIGS. 122 & 123—Set the gap between the spring collars and the hex as shown by the arrows and tighten the screw just enough to keep them from slipping. If you overtighten the nuts you'll strip them out.

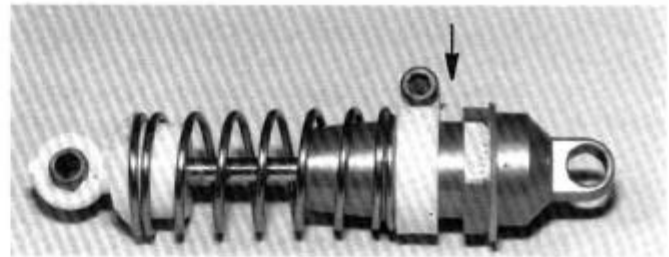

FIG. 122

FIG. 124—From Bag #6-4 mount the shock strut #6378, as shown, with the four screws indicated.

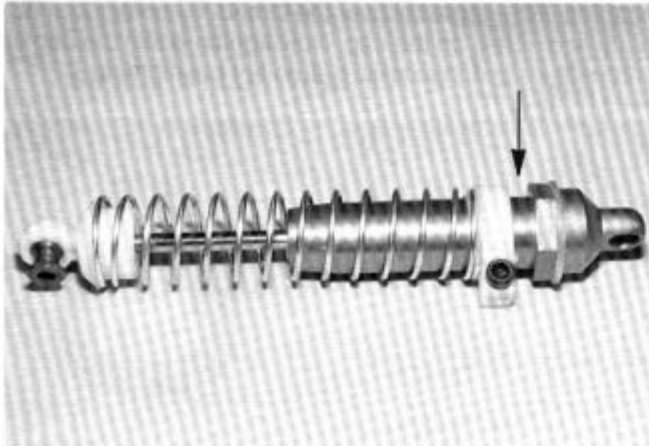

FIG. 123

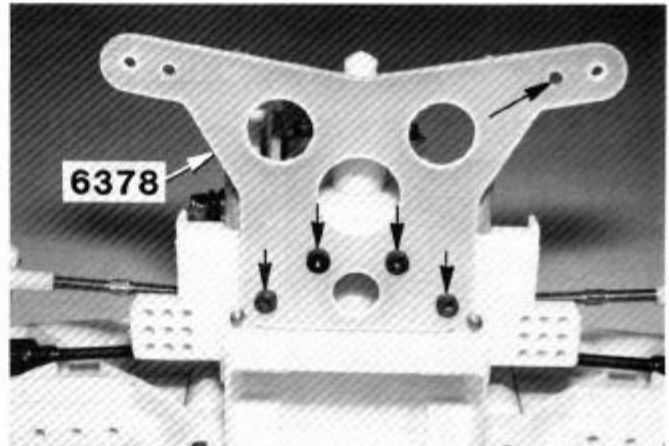

FIG. 124

FIG. 125—From Bag #6-9 push through one of the long 4/40 screws into the shock strut, in the inside hole as shown in Fig. 124, and tighten down. Now slip a washer on the screw and a nut and tighten. Now slip the shock bushing on with the flange end first, as shown.

FIG. 126—Now slip the shock onto the bushing, then a washer and then the locknut. DO NOT overtighten the locknut. It should be just snug so the shock can swing FREELY.

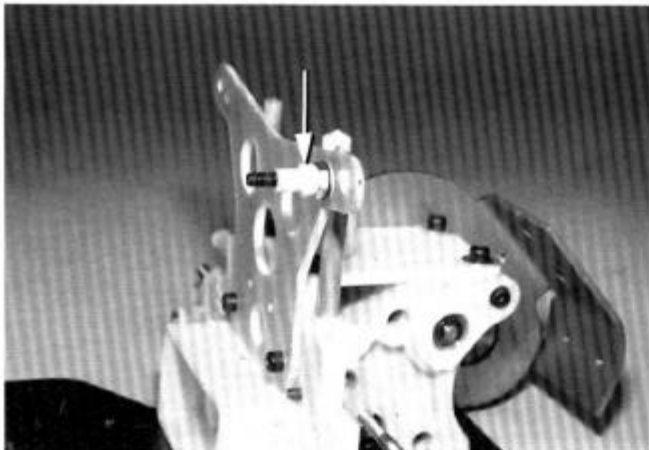

FIG. 125

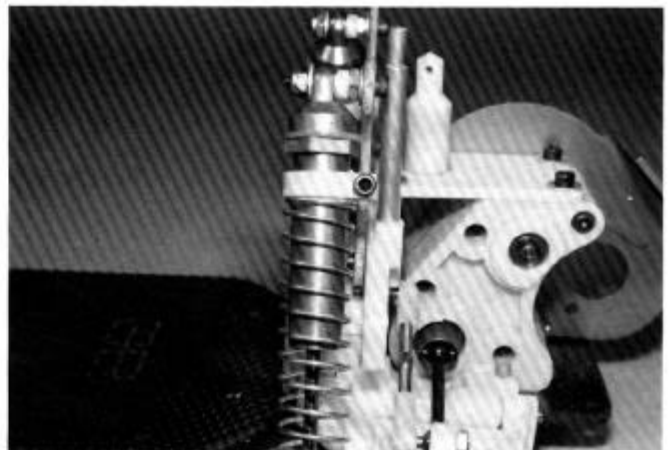

FIG. 126

FIG. 127 & 128—Now mount the bottom end of the shock in the outside hole, as indicated in Fig. 128. Make sure the flat area of the ball is against the arm, as shown in Fig. 127. You can tighten this screw securely. Mount the right hand shock.

IMPORTANT: now refer back to Fig. 106 where the dogbone goes into the output drive of the transmission. We must make sure the dogbone is not **TOO LOOSE** or **TOO TIGHT** here. If it's too loose the dogbone will drop out of the outdrive when the wheel drops all the way down. If it's too tight it will bottom out and bind when the wheel is all the way to the top of its travel. So raise the arm completely and lower the arm completely and check the dogbone. If it must be adjusted then you will have to re-locate the washers you installed in Fig. 105 to the inside, with just enough washers to make the fit correct.

ALSO IMPORTANT: any time you change the length of the turnbuckle in Fig. 109, you'll also have to check the dogbone clearance.

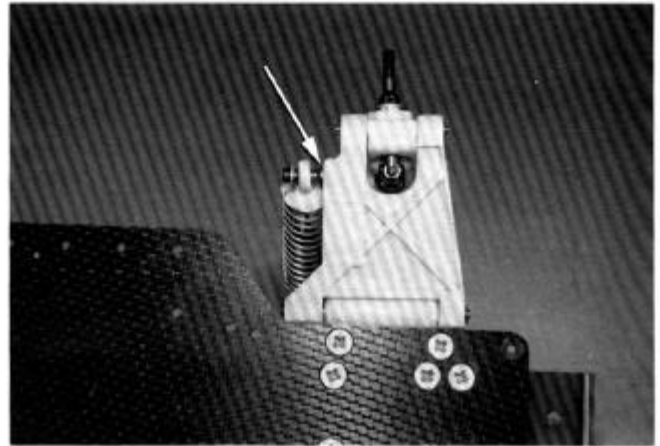

FIG. 127

FIG. 129 & 130—From Bag #6-10 install the upper shock mount in the location shown.

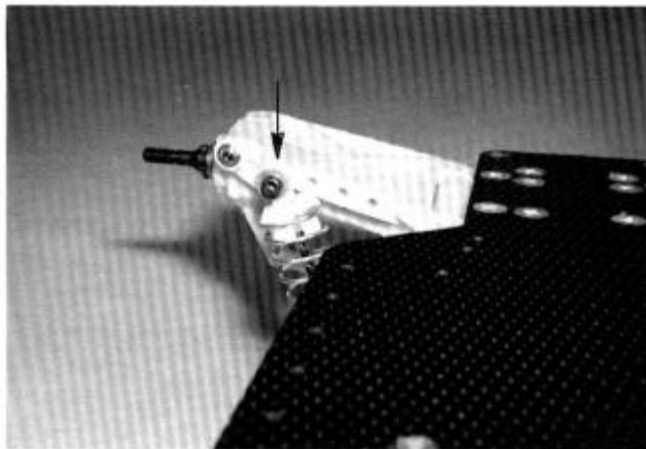

FIG. 128

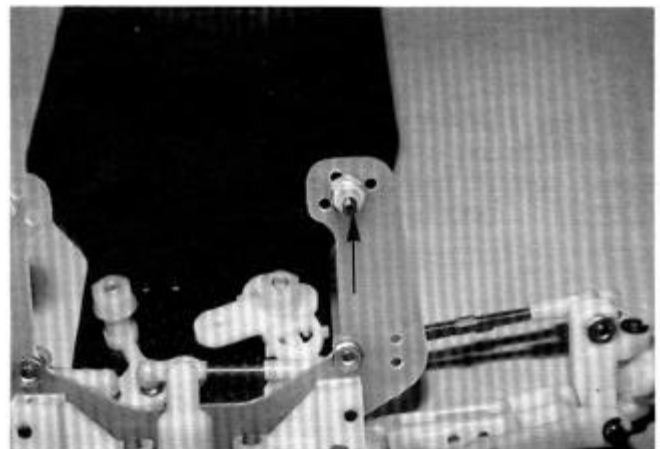

FIG. 129

FIGS. 131, 132 & 133—Install the front shock; do not overtighten the upper nut. The shock must swing freely. Screw the lower screw in the inside hole and

tighten the screw. Make sure the flat side of the ball is towards the rear, as shown in Fig. 133. Do the right hand side.

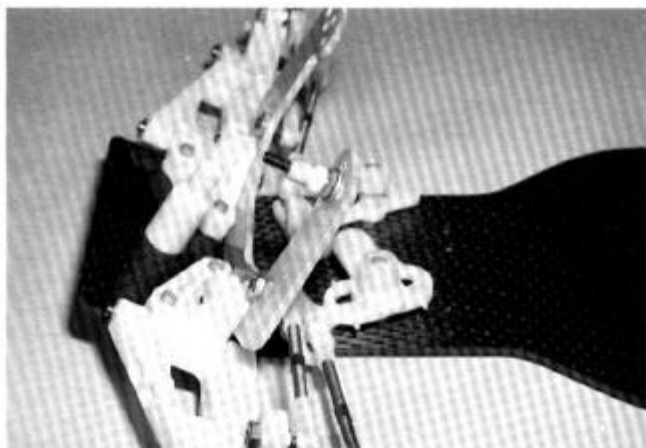

FIG. 130



FIG. 131

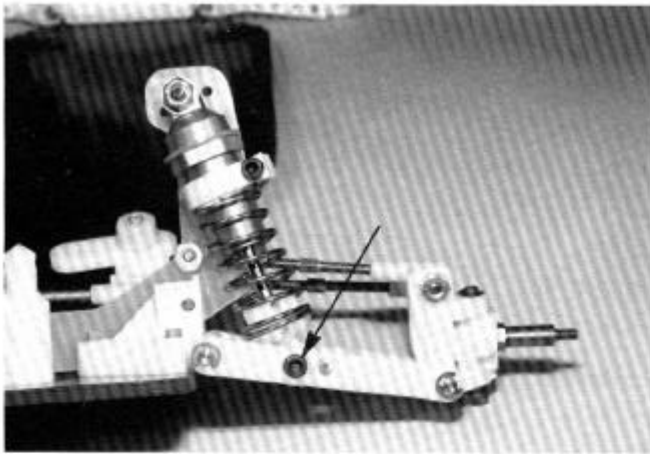

FIG. 132

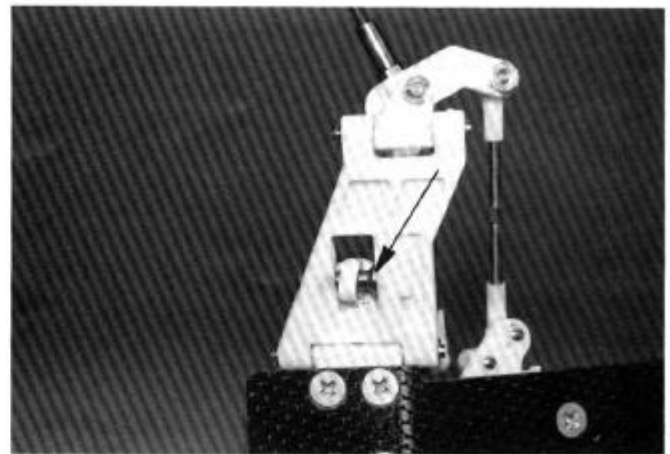

FIG. 133

MOTOR INSTALLATION

FIG. 134—Time to put the horsepower in the car! Using ROSIN core solder, solder the motor lead wires and filter capacitors to the motor according to the instructions included in the motor bag.

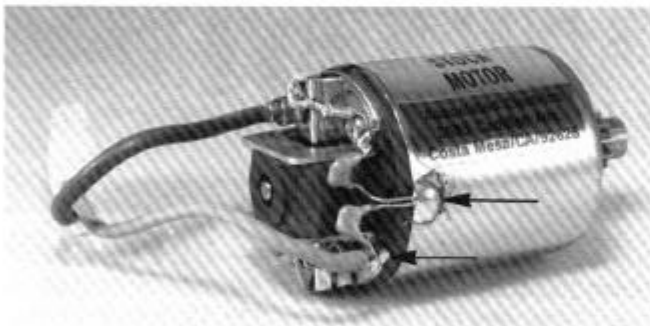

FIG. 134

FIG. 136—In the motor bag are two metric motor mounting screws. These screws have fine threads and are used only to mount the motor. Slip the motor into the motor mount and start the bottom screw in first. Do not tighten all the way down yet. For the top screw, put a washer on the screw and screw it in, but not tightly.

Now we'll set the gear mesh. By moving the upper screw forward or back, we'll be moving the motor closer to or away from the plastic spur gear. We want to get the metal pinion gear as close to the plastic spur gear as we can without binding up the gears. The easy way to check this is to put your finger on the plastic gear and see if you can rock it in the teeth of the metal gear. The two gears should be as close as possible, while still being able to very slightly rock the plastic gear. When you have this correct spacing, tighten down on the two motor screws and re-check the gear spacing. An incorrect gear mesh can result in a huge power loss, so do it correctly.

FIG. 135—Push the motor pinion on the motor as shown, so the end of the pinion is even with the end of the shaft. Use the gearing recommended by the motor manufacturer (usually a 14 or 15 tooth for stock motors and 12 or 13 tooth for modified motors). Associated has a selection of Reedy racing motors and special gears.



FIG. 135

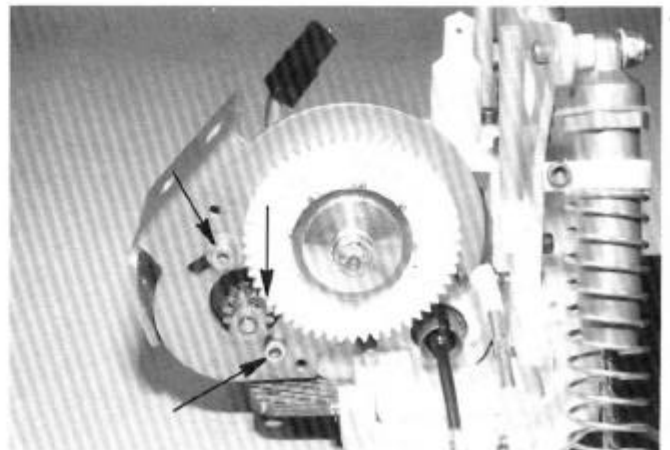

FIG. 136

FIGS. 137 & 138—Now we'll install the #6608 dust cover, found in Bag # 6-12. You'll have to trim the dust cover with scissors to fit. But we want the dust cover to fold over the edges of the motor mount as far as possible. So slip the dust cover on, see where you have to trim, and cut off only as much as you have to until you can snap the cover on. When the cover is on, you'll notice two indentations in the plastic where the two screws go. If you take an X-acto knife and twist it as you push, you can cut the two mounting holes

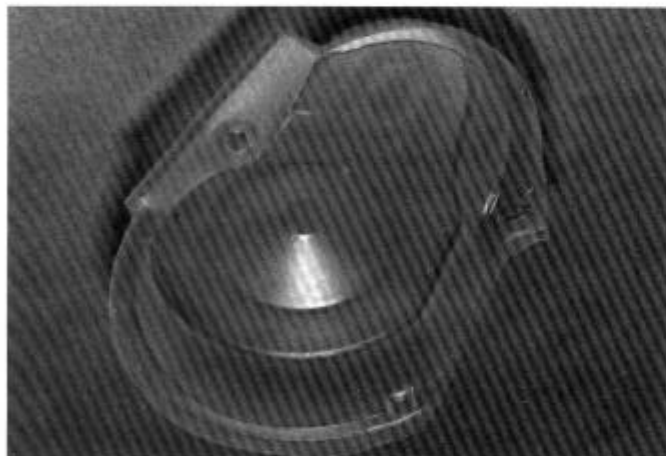

FIG. 137

in the plastic, otherwise you can use a drill. Screw in the two mounting screws with washers as shown.

CAUTION: to remove the motor, you must first remove the dust cover. You will then have four screws out that look the same. But if you mix up the dust cover screws with the motor screws, you will strip out the threads. Keep the motor screws with the motor, and the dust cover screws with the dust cover. Also, **DO NOT** try to use aluminum screws to attach the dust cover because they will break off in this installation.

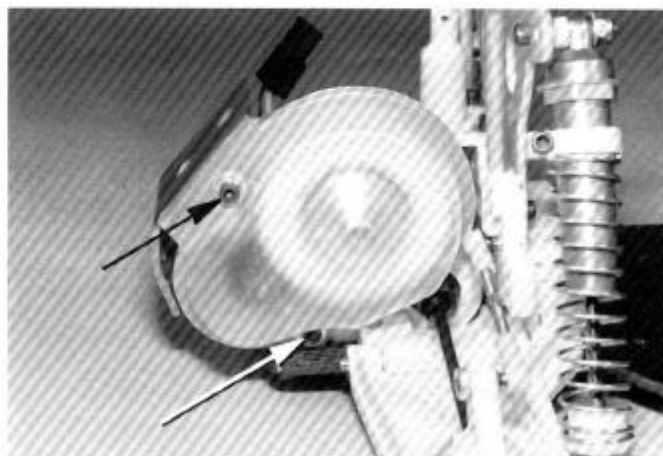

FIG. 138

RADIO INSTALLATION

FIGS. 139, 140, 141, & 142—We're ready to install the radio. If you haven't purchased a radio yet, a good choice would be one of the 2-channel steering wheel systems made by Futaba or Airtronics. However, many other radios, including stick models, can be used in the car. The higher torque, medium-sized servos (like the S31, S131 or S28) are preferred for steering, but all three sizes, small, medium and large, can be made to work. The photos that follow show the installation of a Futaba system. In these instructions, servo sizes (the width of the case between the mounting ears but not including the ears) are grouped as followed:

small (S32)	1.5 in. (38 mm)
medium (S31)	1.6 in. (41 mm)
large (S29)	1.8 in. (46 mm)

STEERING SERVO. From Bag #6-6, remove two of the plastic servo mounts #6336. You'll have to drill the mounts for your particular servos. If you have S32 servos, line up your servo with the mounts so there will be about 1/16" (1.6 mm) clearance between the servo and the chassis plate and mark the hole locations on the mounts. Drill two #43 (2.3 mm) holes in each mount on the side away from the

chassis mounting hole, which will be on the bottom of the mount. You'll notice that the chassis has two sets of servo mounting holes—a short set and a long set. With two different sets and by rotating the servo mounts 90 degrees, you will be able to mount most servos. Put the rubber grommets on the servo and attach the servo to the mounts with four Allen screws and washers, as shown in Fig. 139.

Mount the servo to the chassis with the two flat head Allen screws shown in Fig. 141. You'll have to add two washers between the rear mount and chassis for proper alignment.

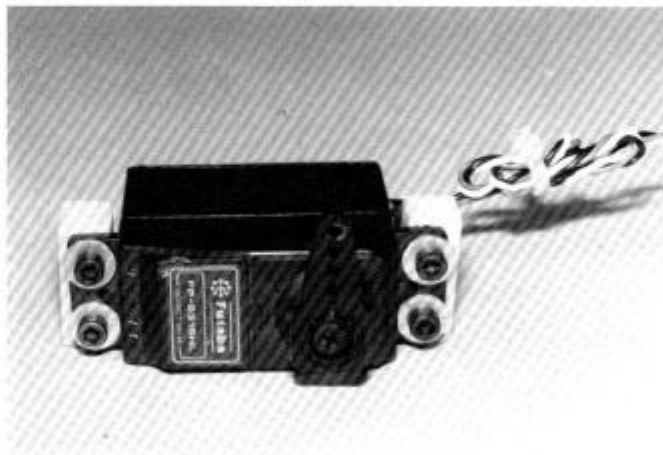

FIG. 139

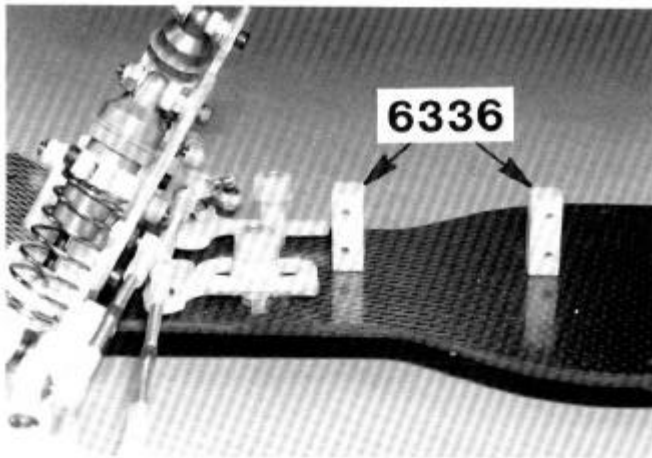

FIG. 140

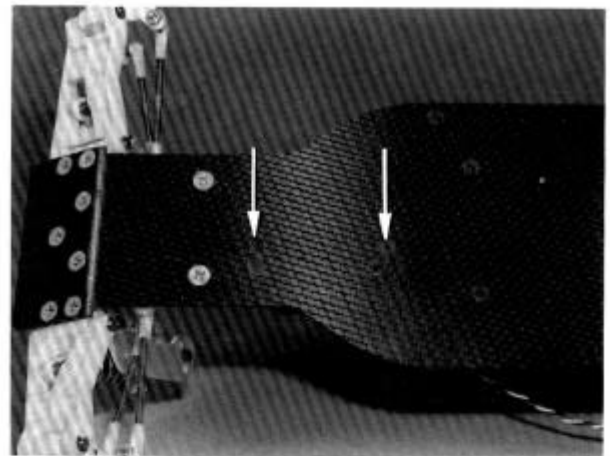

FIG. 141

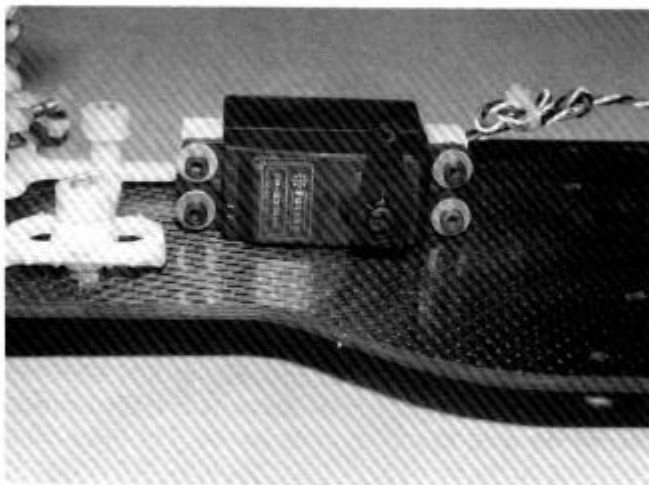

FIG. 142

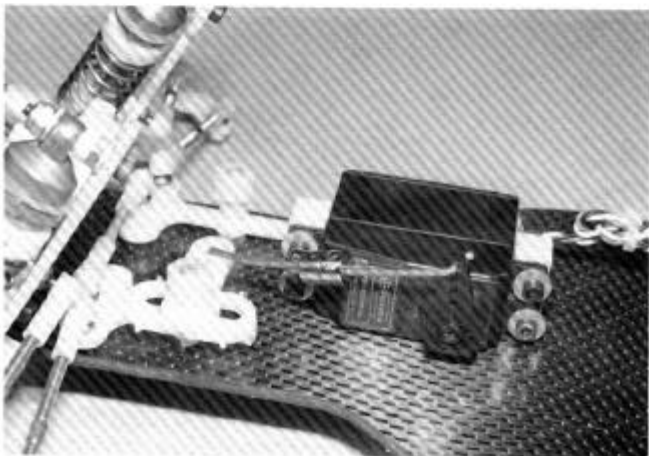

FIG. 143

FIG. 143—Remove from Bag #6-2 the piano wire linkage and set collars. Turn the servo output arm to the left and right stops and then center the arm between these two stops. It will not be exact, but it will be close enough for now. We'll center it exactly with the radio later. Slip one of the "Z" end arms in the servo arm as shown. The "Z" bend arm will be easier to push through the servo saver arm if you take your X-acto knife and rotate it in the hole to bevel it slightly. Center the servo saver and slide on and tighten both locking collars.

SPECIAL INSTRUCTIONS: MEDIUM STEERING SERVO. Medium sized servos include Futaba S31, S131, S28; Airtronics 94461; and Novak NES1A. Follow the same procedures as for the small servo above, but use the wider spaced mounting holes in the chassis. Linkage is the same as for small servo, but may require slightly more bend in the linkage to clear the servo.

SPECIAL INSTRUCTIONS: LARGE STEERING SERVO. Large servos include Futaba S27, S29, as well as several older designs. Follow the instructions above except that the rear servo mount should be rotated 90 degrees. This will move the mounting point well away from the existing holes in the chassis to make it easier to drill another hole. Temporarily install the front mounting screw, position the servo, and then mark around the rear mount. Remove the servo and mark a spot to drill within the outline of the mounting block. Center punch the mark and drill the chassis with a 1/8" (3/1 mm) drill. Countersink the hole on the bottom of the chassis if possible. (You can use a large (approx. 3/8") drill and turn it by hand to do the countersinking.) Mount the servo and install the linkage. Bend the linkage wire to clear the servo.

FIG. 144 & 145—Take the antenna wire tube #6338 and push it into the plastic antenna mount. Now take your receiver's antenna wire and push it all the way up through the antenna tube starting at the antenna mount so there's one inch sticking up through the top. Then tie a knot in the wire so it can't pull back through. The wire will go in easier if there are no kinks in the wire.

Now set the antenna mount over the mounting hole in the chassis and position the receiver as shown. See how much antenna wire you need to get from the antenna to the receiver, and take the extra antenna wire and neatly tie wrap and tape it to your receiver with double sided tape as shown in Fig. 144. Tape the receiver to the chassis with double sided servo tape, as shown in Figs. 145 and 150. Attach the antenna mount to the chassis with the flat head Allen screw. Plug the steering servo connector into the steering servo slot in the receiver.

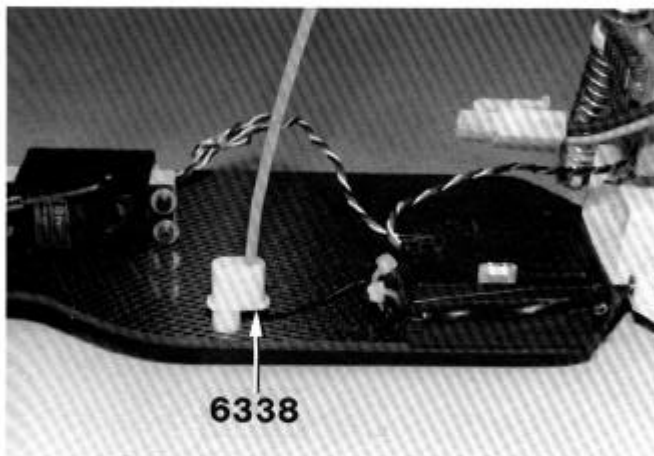

FIG. 145

FIG. 147—A good place to attach your on/off speed control switch is shown here. Use double-sided servo tape.

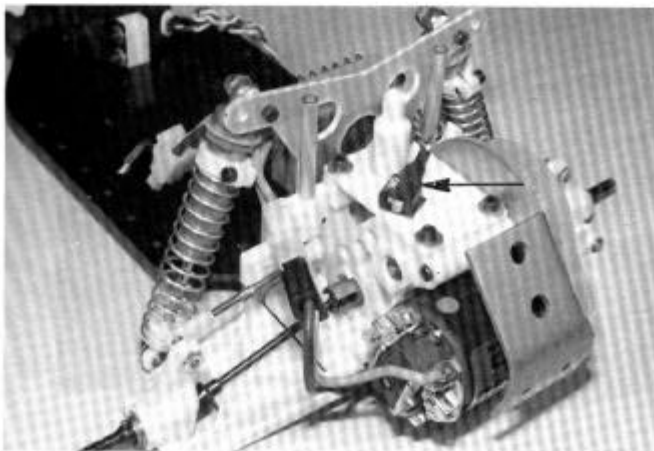

FIG. 147

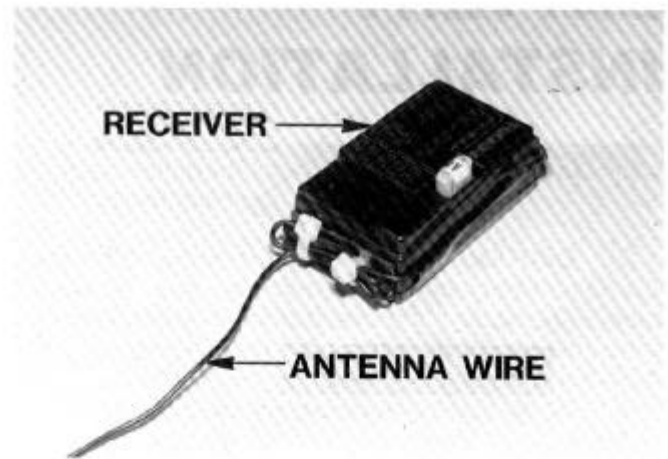

FIG. 144

FIG. 146—Attach your speed control to the shock strut with double sided servo tape as shown. Plug the speed control connector into the throttle servo slot in the receiver.

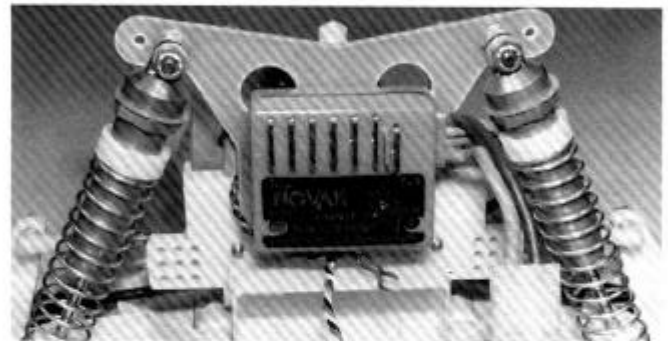

FIG. 146

FIG. 148—Mount the battery cup #6334 from Bag #6-7 to the chassis with the two flat head Allen screws. Then mount the battery retaining strap as shown. The screw on the swing end should not be tight. The screw on the slotted end should be loose enough so the strap can be pushed down over the head of the screw head; then you can slip lock it in place.



FIG. 148

BATTERY INSTALLATION

FIG. 149—Before we install the battery pack, you need to be warned of certain battery characteristics:

CAUTION. Ni-Cd batteries are susceptible to damage when overcharged at a high rate, and can release caustic chemicals if the overcharge is severe. Read the battery charging instructions in this manual before attempting to run your car.

Do not stall the motor under power. If the car stops suddenly on the track, or fails to move forward when you attempt to accelerate (after hitting a wall, for instance), push the throttle control on your transmitter to the brake position immediately and attend to the car. A small rock may have stalled the gears, and if the throttle is left in the "on" position, the result can be a burned-out motor or electronic speed control unit.

If you run your car to the point where more than one cell in the pack is completely discharged, it is possible to lose radio control of the car before the drive motor stops completely. For this reason you should not operate your car in an area where it could be damaged or cause harm to others, such as near a pool of water or a busy roadway.

Usually radio control will be regained as soon as you pull the car from the obstruction and the motor is allowed to free-run. If you still don't have control, then you should turn the switch off.

Whenever you stop running your car, turn off the radio at the car **FIRST** before turning off the transmitter.

Make sure your switch is in the off position while you are charging the battery.

A partially burned-out or shorted motor can make the car appear to have radio problems. If the car slows down suddenly and acts erratically even with a full battery charge, then the cause is probably the motor. Check the range of the radio with the motor unplugged. A shorted motor will draw extremely high current even under no-load conditions.

WARNING. Using Ni-Cd packs with two-pin connectors designed for aftermarket or for other car brands can be hazardous. Some of these packs can be plugged into the connector on the RC10 Graphite in a variety of incorrect ways that can burn out your radio equipment and wire harness. All ASSOCIATED packs for the RC10 Graphite have connectors which can be inserted one way only.

Do not charge your battery pack yet. However, you can place it in the car to make sure everything fits. Just don't plug it in yet. Also, don't plug your motor into your speed control yet.

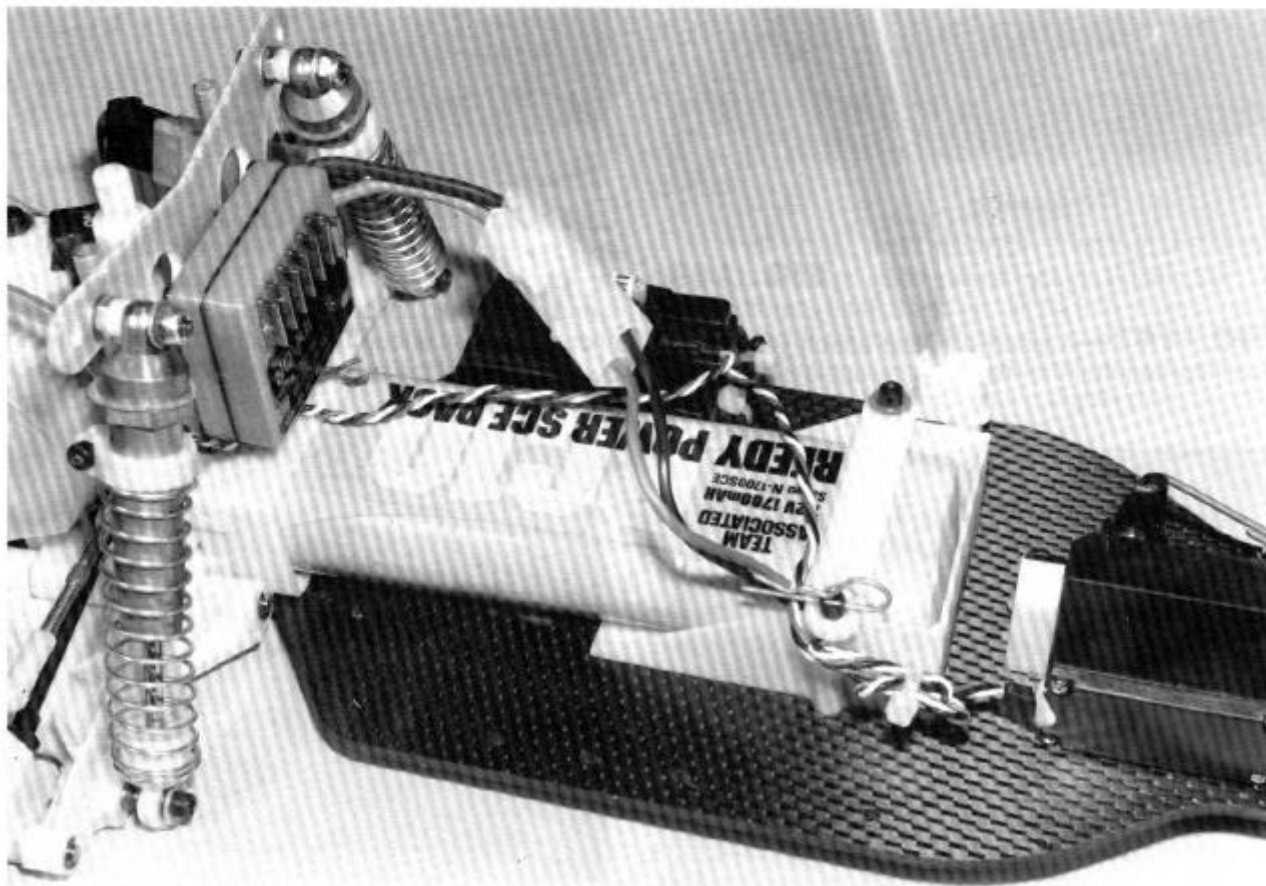

FIG. 149

FIG. 150—Your radio installation should look like this. Now let's get the tires on.

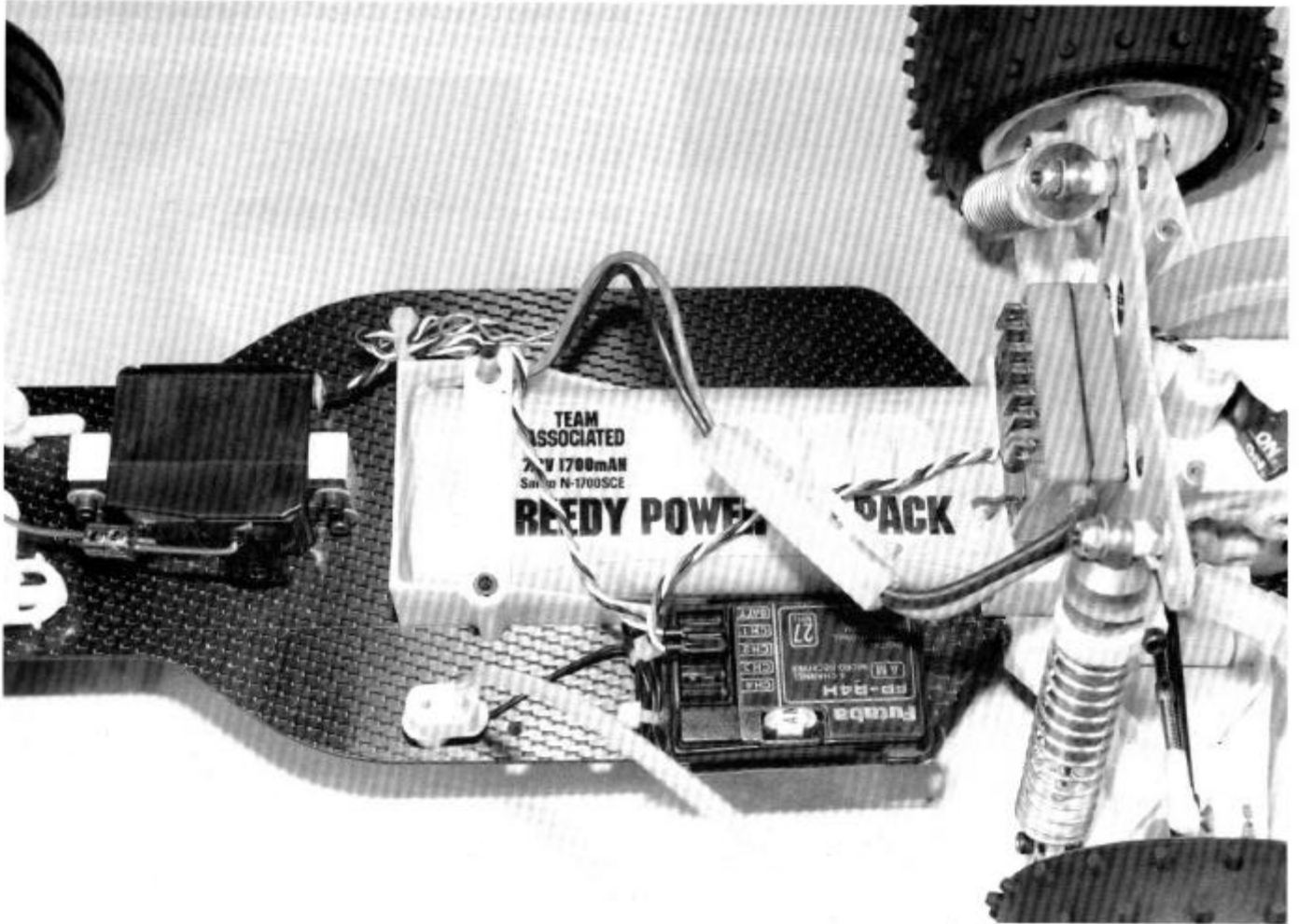

FIG. 150

WHEELS AND TIRES

□ **FIGS. 151, 152 & 153**—Take the front tires and work them onto the wheels with your hands. They will go on a little tight, but they do go on.

Push the ball bearings or bushings into the front

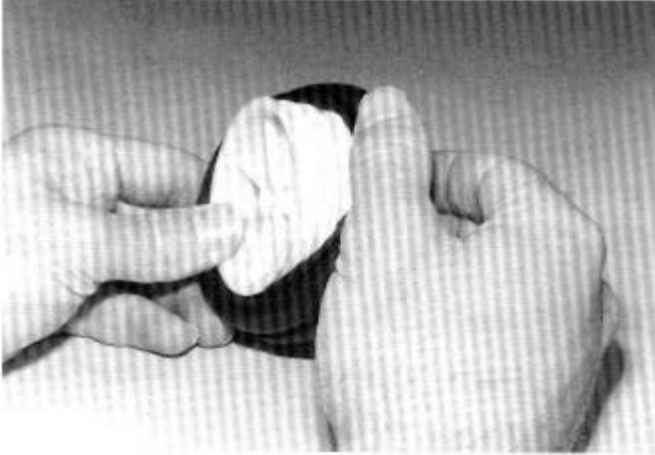

FIG. 151

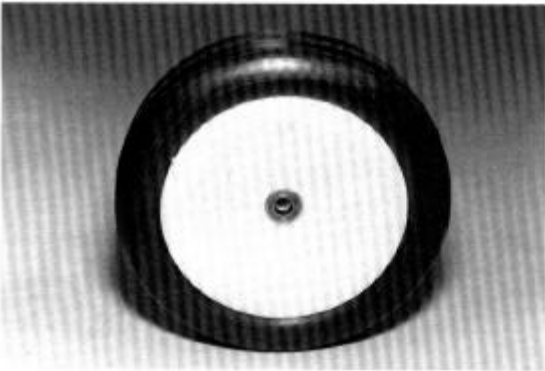

FIG. 153

□ **FIGS. 155 & 156**—Now slip the rear wheels all the way on with the slot going over the roll pin. Screw on the plastic wing nut. Put the front wheels on and secure them with wing nuts. Do not overtighten.



FIG. 155

wheels. Slip one of the wheels onto the axle and spin it to make sure you've got the tire mounted correctly so it doesn't wobble. You want it to be true. Do the other front wheel.

Slip both of the back tires all the way on their wheels. Put them on the rear axle. If you turn one wheel, the other wheel should turn too. Check to make sure they both turn true.



FIG. 152

□ **FIG. 154**—Use a cyanoacrylate adhesive, such as pink ZAP or Hot Stuff, to glue the tires to the wheels. THIS IS A MUST. If you do not glue them on, they will slip, fill up with dirt and go out of round.

You'll also need to let air in and out of the tire. So take your X-acto knife and poke a 1/16" slit into the inside wall of all four tires.



FIG. 154

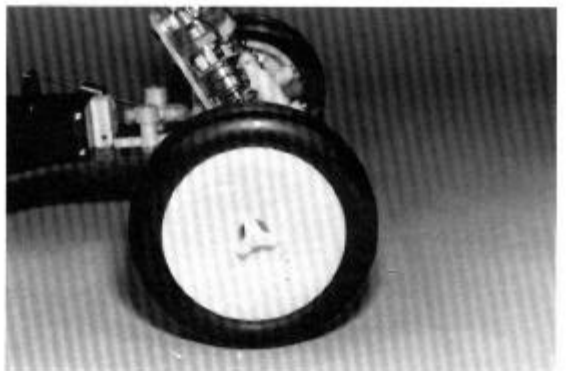

FIG. 156

BODY AND WING

FIGS. 157, 158 & 159—Time to mount and trim the body. The body is generally easier to trim when it's clear (before you paint it). Don't cut too much away. You'll probably have to measure, mark and drill your antenna hole first before the body mount holes.

Painting. The bodies are painted on the inside. Using automotive masking tape, mask off the windows first. Then mask off your paint design. Use Pactra R/C car body paint available in all hobby stores. It's the best. **DON'T PUT TOO MUCH PAINT ON.** It can make the Lexan body brittle and crack it.

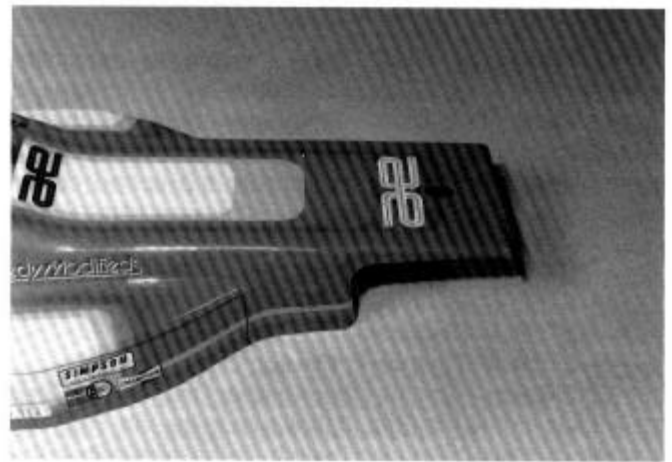

FIG. 157



FIG. 158



FIG. 159

FIGS. 160 & 161—Assemble your wing as shown.

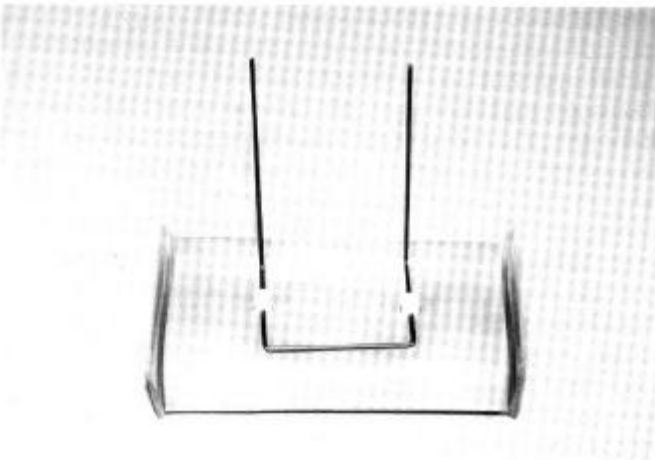

FIG. 160

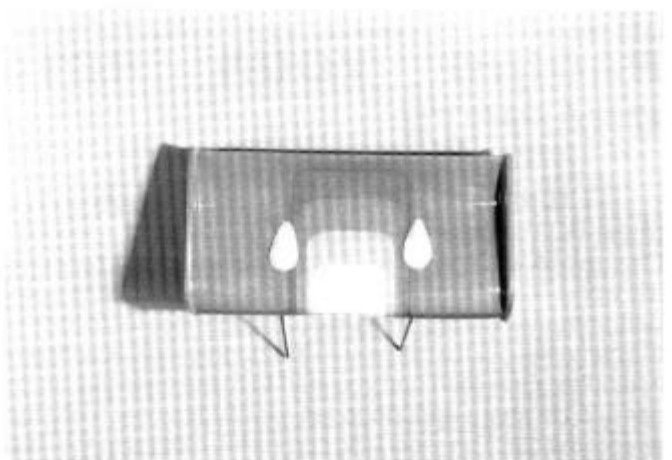

FIG. 161

FINAL ADJUSTMENTS

BATTERY CHARGING. Charge your transmitter batteries if they are Ni-Cds. This charge will take overnight. Charge your car pack according to your charger manufacturer's recommendations. Make sure all the speed control connections are according to the speed control manufacturer's recommendations. Then go on to the following:

- STEP 1—Turn the transmitter switch ON.
- STEP 2—Make sure the motor is UNPLUGGED.
- STEP 3—Plug in your car batteries.
- STEP 4—Turn the car switch ON.

STEP 5—Turn the steering wheel to the right. See if the wheels turn to the right. If they turn to the left, you have a steering servo reversing switch in the transmitter that should be switched to the opposite position. Read your radio manual for more details.

STEP 6—When your wheels turn in the correct position, take your hands off the steering wheel. Is the servo arm on the steering servo centered? Refer to Fig. 139. If it's not centered, you'll have to remove the servo arm screw and center the arm.

STEP 7—Are your wheels now pointed straight forward? If not, refer to Fig. 143 and loosen the two linkage set collars, center the wheels, then re-tighten the collars.

STEP 8—Leave the transmitter switch ON. Turn the car switch OFF. Plug your motor into the speed control.

STEP 9—A word of caution here. You'll want to have the car sitting up on a block so the rear wheels cannot touch anything before you turn the car switch back on to set the speed control. Turn your car switch ON. Now set the speed control according to the speed control manufacturer's recommendations.

STEP 10—When you're done setting the speed control (and probably playing with the throttle) turn the car switch OFF.

STEP 11—Turn the transmitter switch OFF. The transmitter switch must always be the FIRST SWITCH TURNED ON and THE LAST SWITCH TURNED OFF.

YOUR CAR IS NOW READY TO RUN!

RACING YOUR RC10 GRAPHITE

TUNING TO WIN. The RC10 has won both classes of the ROAR Nationals and the 2WD class of the World Championships against the toughest off-road competition in the world. Your RC10 Graphite car is capable of the same performance. The first thing to do, though, is to learn to drive the car to the point when you're thoroughly familiar with how it handles. Only then can you start to make changes on the car and be sharp enough to tell exactly how each change affects the car. The racer who comes the closest to the ideal combination of springs, dampening, ride height, gearing,

cambers, wing, etc. for his track will have the easiest car to drive, giving him the best chance to win.

THINGS TO TRY. You can change the dampening of the car by changing the oil in the shocks. 30 wt. oil will make the shocks a little harder to actuate. 40 wt. is getting near the maximum to try.

Your kit also contains two different sets of springs to try on your track. Silver is the softest and gives the most rear end traction. Gold is stiffer and is usually used on high traction tracks. Try different combinations to see what works best for you. Each off road track is different and the object is to experiment to find the ideal combination for you.

OVAL RACING. Because the RC10 Graphite chassis is fully race tune-able, it can be adjusted to give ultimate oval track performance. Springs, dampening, ride height, wings and especially camber can be adjusted to create an ideal oval combination. You can try giving the front and rear outside wheels up to 10 degree of increased camber by turning the top turnbuckles.

DIFFERENTIAL ADJUSTMENT. The limited-slip (VariLok) ball differential on your RC10 Graphite works just like the dif on a full-sized car—it allows the outside rear wheel to turn slightly faster than the inside when the car is cornering. The limited-slip feature prevents that wheel from turning too fast when cornering under power.

You can make sure the dif on your car is working properly by doing the following: First remove the gear dust cover. Then lift the rear of the car off the ground with your left hand and press your thumb against the teeth of the large plastic gear to prevent it from turning. Now turn the right rear wheel with your other hand. The wheel should turn easily, and the OTHER wheel should turn in the opposite direction at the same time. A well set-up dif will act this way even if you don't keep the large gear from turning; just the drag of the motor should be enough to hold it.

Now place the car on the ground and push down on the rear end to compress the suspension. While holding the car in this position, try to turn the large gear with your thumb. It should be nearly impossible to turn the gear, and if it does turn, the wheels should turn with it.

If your dif isn't working properly and adjustment of the dif nut doesn't fix it, then remove the dif nut, spring, hub, drive rings, and large gear. Now you can make two checks: lift the car and make sure that both rear wheels will spin freely. Next, grab hold of the inner dif hub (the aluminum thing you just took the gear off of) and try to turn it while holding the RIGHT wheel. There should be no slippage. Now temporarily slide the outer dif hub back on the dif shaft and try to turn it while holding the LEFT rear wheel. Again, there should be no slippage. If you can pass these tests then you can be pretty sure that the gears are not slipping or binding inside the transmission.

Next, clean, regrease and reassemble the parts you removed. Make sure the large gear turns freely on the inner dif hub as you put it together.

LOCKING THE DIF. In some situations you might want to lock the dif completely. To do this, simply remove the dif balls from the large gear, wipe the grease off the gear and drive rings, and reassemble as usual, but without the balls. Tighten the nut all the way down to the point where the spring is almost fully compressed.

If the dif fails to lock up even when the spring is fully compressed, then the inside of the outer hub (#6624 in Fig. 76) may be bulged slightly, preventing complete lockup when assembled without the balls. This problem can be fixed by sanding off the bulge, rubbing it against a piece of emery paper laying on a flat surface. (The bulge is on the side OPPOSITE from the spring cup; don't sand off the spring cup!)

NEVER attempt to lock the dif by assembling without the spring, and DO NOT overtighten the dif nut to the point where the spring is completely collapsed. A certain amount of slippage under impact is necessary to protect the gears from damage.

RC10 GRAPHITE MAINTENANCE

You'll find your RC10 Graphite car will give you many more hours of trouble-free operation than any other car available now. You should periodically check all the moving parts: front and rear A-arms, steering blocks, steering linkage, shocks, and so on. If any of these should get any dirt in them and start sticking, it will greatly impede how the car handles.

MOTOR MAINTENANCE. Because we're running out in the dirt, it is possible for dirt to make the brushes stick. So, if you're having motor problems, one of the first things to check is to make sure the brushes are still able to move freely in the brush holders.

If you've run enough to wear them out, Associated has replacement brushes available. A helpful product which will give you a little more power and make the brushes and commutator last much longer is Associated's Reedy-in-a-Can Power Spray #6550. Simply spray a short burst of this on the brushes and commutator every time before you run and it will clean and lubricate the brushes and commutator. For those of you who want more power, Reedy Modified motors are available. Associated's #6510 is used for off road tracks and the #6511 is for oval track racing.

RADIO MAINTENANCE. A radio problem is not always caused by the radio. Often it is the result of a combination of factors which can include motor noise, poor electrical connections or layout, reversed or defective crystals, weak transmitter battery, and so on. If your radio problems persist, one or all of the following tips may help:

Make sure your motor noise capacitors are properly installed.

Make sure the brushes are free in their brush holders and are not arcing.

Try a different frequency.

Try a different motor.

Lengthen your receiver antenna and/or raise the antenna mount up to the rear shock strut.

Dress the radio wires well away from the power leads of the motor.

Note also that 75 mhz band radios and Electronic Speed Controls are more susceptible to interference. Large metal objects such as chain-link fences, light poles, cars, vans, or trailers parked near the track can cause local interference, particularly on 75 mhz.

RESISTOR OR ELECTRONIC SPEED CONTROL—which is the best? Good question. We've found it's very hard to tell the difference in the performance of a properly working resistor with bypass and an electronic speed control. However, for those of you who want to use a speed control, Associated has two good ones by Novak. They are a little complicated to install and adjust, but they require less maintenance than a resistor. Make sure to use the heat sinks with them.

CHARGING BATTERIES

It is important to understand the characteristics of the battery pack in your car because how you use it will greatly affect both its performance and its life. With proper care your pack will perform well for many hundreds of cycles.

The ROAR legal battery supplied with your car is composed of six "sub-C" size cells with a maximum rated capacity of 1.2 amperes for one hour, or 2.4 amperes for 1/2 hour, etc. This charge capacity is the same regardless of the number of cells in the pack because the cells are connected in series and the same current passes through each one.

CHARGER. Associated makes a #6772 Off Road Charger which will make your charging a whole lot easier. It includes an ammeter, to show the charge rate, and a 30 minute adjustable timer.

OVERCHARGE. There is no way to make a Ni-Cd cell accept more charge than it is designed to hold. This means that as the cell approaches a fully charged condition, the portion of charging current not being stored becomes heat and pressure. If charging continues after the cell is fully charged, all of the current is converted to heat and pressure—about 40 watts worth, or the equivalent of the heat produced by an average soldering iron. High temperature and pressure is damaging to the cells, so overcharging must be avoided.

Ni-Cd cells have a built-in process for recombining the accumulated gas (actually oxygen) produced by overcharge, but the process produces heat and takes a lot of time. If you overcharge your battery and it seems to take a long time to cool down, it's because this pressure reducing reaction is taking place. Once the gas is recombined the temperature drops.

HOW TO TELL WHEN YOUR CELLS ARE CHARGED

One of the problems with Ni-Cds is their inherent voltage stability; the voltage of a fully charged cell is not much different from one that's just about dead. For that reason several indicators, along with some common sense, are needed in order to get the most out of your battery. The following is a list of indicators you can use to detect full charge.

TEMPERATURE METHOD. This works only if you start with a cool battery pack. As the pack charges, frequently check its temperature by feeling the cells directly. As soon as you notice an increase in temperature, stop charging. If the cells become too hot to hold onto, your cells are excessively overcharged. Let them cool.

TIMED CHARGE METHOD. This works only if you have confidence in the timing accuracy of your charger. Many chargers on the market only approximate a constant charging current; they may vary from six amps when you first start charging, all the way down to two amps if the Ni-Cd pack is nearly charged and the voltage of the charging source (automobile battery) is low. If the charging current varies, it becomes difficult to estimate the average current. However, if your charger is reasonably dependable, you can use the following method.

Charge your pack using the "temperature method" above and keep track of the time required to reach full charge. Once you have established the time, you can use it as a setting for the timer on your charger. To be safe, use a setting about a minute less than what you established. This method allows you to charge without constantly monitoring the battery temperature.

If you charge a battery that is still hot from running, reduce the time about 20%. Then, after the pack has cooled, finish charging with the temperature method.

VOLTAGE METHOD. Voltage is a poor indication of a cell's state of charge. In fact, other factors like temperature, current drain, and "cell memory" have as much of an effect on voltage as the state of charge does. However, if current flow and temperature are held constant, it is possible to see the cell voltage gradually climb during the charging process. The absolute value of this voltage isn't of much use—how the voltage changes is an excellent indicator. To use this method, you will need a digital voltmeter or an expanded-scale voltmeter capable of resolving 0.01 volts on the 10 volt range.

Connect the voltmeter across the Ni-Cd pack, preferably right at the cell terminals, or, if that's not possible, across the terminals of the throttle control resistor. Don't try to read the voltage at the output of the charger because you'll end up reading the voltage drop through all the

connectors and cables between the charger and the Ni-Cd pack, which can sometimes distort the effect you're looking for. You should start with a Ni-Cd pack that is less than half charged. Connect your charger and begin charging at four amps. If your charger is adjustable, set the current now—but don't try to change it later. A constant current charger is preferable here, but if yours gradually drops off during charge, that's still permissible, as long as it doesn't drop below three amps.

Watch the voltage as the pack charges. Notice that the voltage at first climbs rapidly and in the middle of the charging cycle more slowly. This voltage will most likely be in the range of 8 1/2 to 9 volts for a six cell pack. As the pack approaches full charge, the voltage will begin to climb more rapidly; and as it goes into overcharge, the climb will slow down and then stop. This is where you stop charging—at the point where the voltage stops climbing. If you left the charger on, the voltage would begin to fall as the pack went deeply into overcharge and started to heat up. The maximum voltage reached will probably be in the nine to ten volt region; the actual value is unimportant.

Do not try to use a conventional voltmeter. Even a good quality VOM with a large, taunt-band, mirrored-scale meter movement is not adequate; by the time you could see that the voltage had stopped rising, it would be too late.

SLOW CHARGE METHOD. Slow or "overnight" charging is a method you are not likely to use often, but it is a good way to bring the pack to absolutely full charge. However, the output voltage of a slow charged pack is slightly lower.

The charging current must be between 0.05 and 0.12 amperes. If less current, the pack will never reach full charge; any more and the pack will overheat. The time required to reach full charge ranges from 15 to 40 hours, depending on the current used. The charger can be left on for a much longer time without harming the cells; however, the output voltage of the pack will be temporarily lowered by an extremely long overcharge. The voltage returns to normal after a discharge-charge cycle.

These next two tips are really for the benefit of serious racers. If you're just out having fun, don't worry out them.

FULL DISCHARGE. Ni-Cd packs perform best if they are COMPLETELY discharged before they are charged. If you are involved in racing, you will have to do this if you expect to win any races! Discharge for at least an hour (preferably overnight with a clip-on resistor) before charging.

Associated Chargers have a discharge function. Various clip-on discharge resistors (about 30 ohms, 10 watts) are available at hobby stores.

TOPPING-UP can give you a little extra voltage at the beginning of a race, as long as you don't overdo it. Put the last minute or two of charge into your pack just before the race starts.

GOOD LUCK IN YOUR RACING!

PARTS LIST

Basic kit contains the following:

Chassis
 Rear wheels and tires
 Front wheels and tires
 Antenna kit
 Dif lube
 Shock wrench/ ball joint tool
 Headlamp set
 Knock-off set
 Bushings or ball bearings

Bag #6-1 Front suspension
 Bag #6-2 Servo saver
 Bag #6-3 Front anti-roll bar
 Bag #6-4 Chassis parts
 Bag #6-5 Body mounts
 Bag #6-6 Servo mounts
 Bag #6-7 Battery mounts
 Bag #6-8 Rear suspension
 Bag #6-9 Rear shocks
 Bag #6-10 Front shocks
 Bag #6-11 Springs and oil
 Bag #6-12 Transmission
 Bag #6-14 Ball ends
 Bag #6-15 Gears

22 TEAM ASSOCIATED

wishes you high-performance racing!

REEDY Modifieds

Reedy Modifieds Are Bursting Through With New Technology

Reedy Modifieds uses advanced R & D computer systems to develop and improve motor performance.^{1,2} Race developed and tested, Reedy motors are 4 TIMES IFMAR WORLD CHAMPIONS, leaping ahead of all competition.⁸

Reedy Modifieds. The Outburst of New Technology.



3585 Cadillac Ave.
 Costa Mesa, CA 92626 USA

Phone (714) 850-9342 Telex 756887

FAX 714-850-1744

(Graph shown represents actual computer readout of Reedy Modifieds motor.)

CURRENT

TORQUE

POWER OUTPUT

OVERALL EFFICIENCY



RC10 GRAPHITE OFF-ROAD RACER

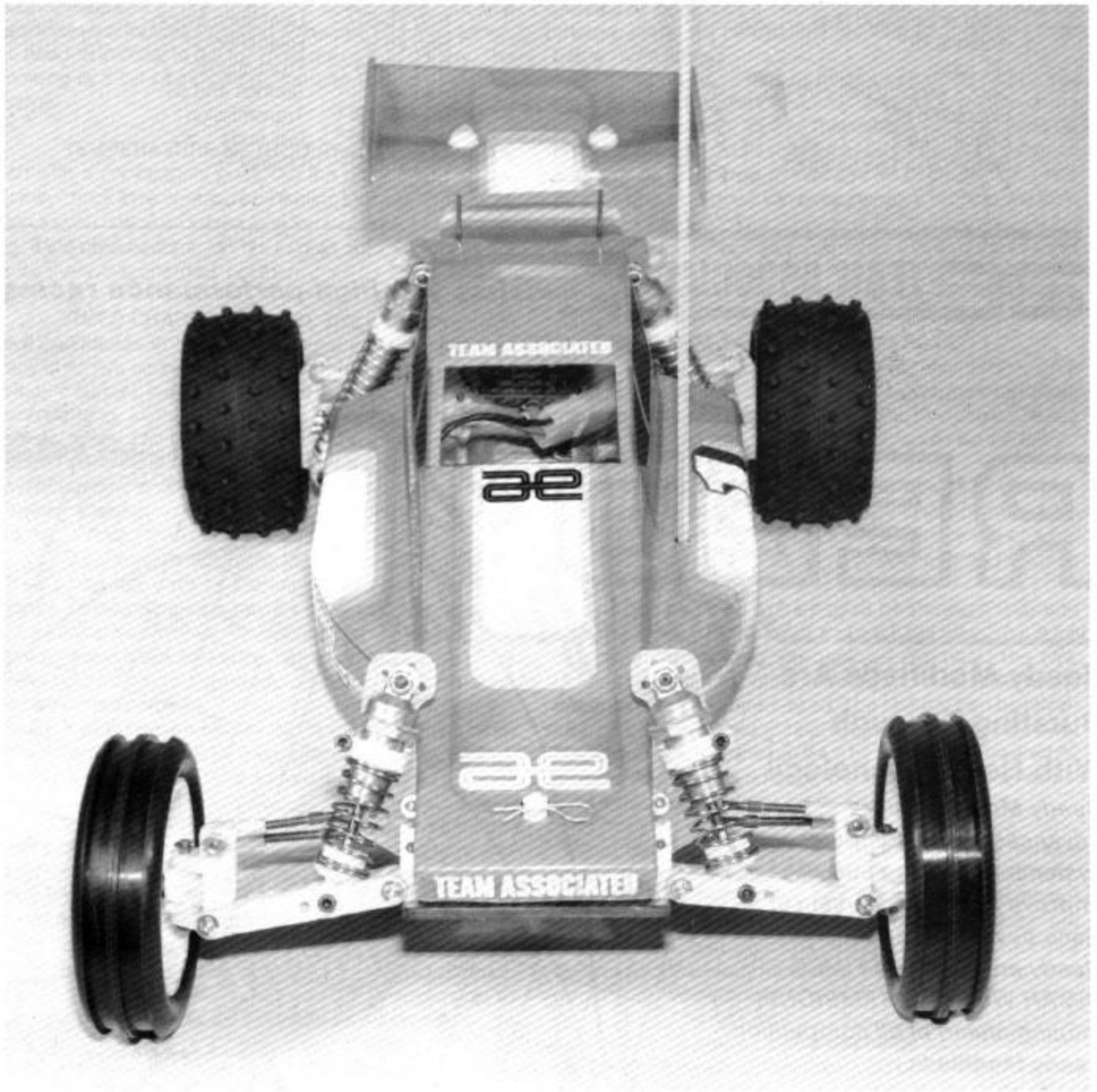

Associated Electrics, Inc.
3585 Cadillac Ave.
Costa Mesa, CA 92626 USA

#6608

DUST COVER

TEAM ASSOCIATED'S RC10 Dust Cover with cap allows you, the racer, to make adjustments to your differential quickly and easily, keeping your car out of the pits and on the road!

STEP 1 With an X-acto knife, cut out the round portion as shown in figure 1 so the cap will seat flush with the surface after you insert it. Cut along the edges carefully in order to form a tight seal for your cap.

STEP 2 Cut out the two mounting holes by drilling them through or using your X-acto blade.

STEP 3 Then trim the excess plastic around the base of the dust cover using scissors or knife.

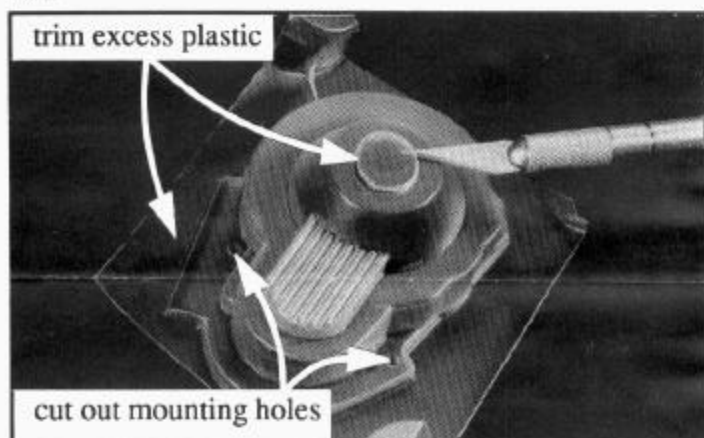

fig. 1

STEP 4 Mount your new dust cover using the same mounting screws and washers already on your car (figure 2).

STEP 5 Firmly push the black cap in until it pops into place, as shown in figure 2. Make adjustments to your dif after popping off the cap with your fingernails or screwdriver.

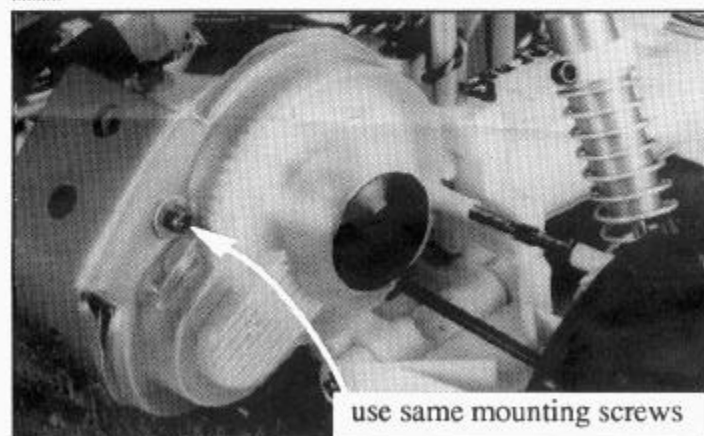

fig. 2

SPECIAL NOTICE

Your A-arms come with excess plastic flash on each end, as shown by the shaded bars below. They were left on to keep the arms stable. However, they must be removed

before you add the A-arms to the car. You can remove them by either twisting the bars with a rocking motion with a pliers, or clip off the bars with a wire clippers.

REMOVE FLASH BEFORE ASSEMBLY

