

RC10L--GRAPHITE

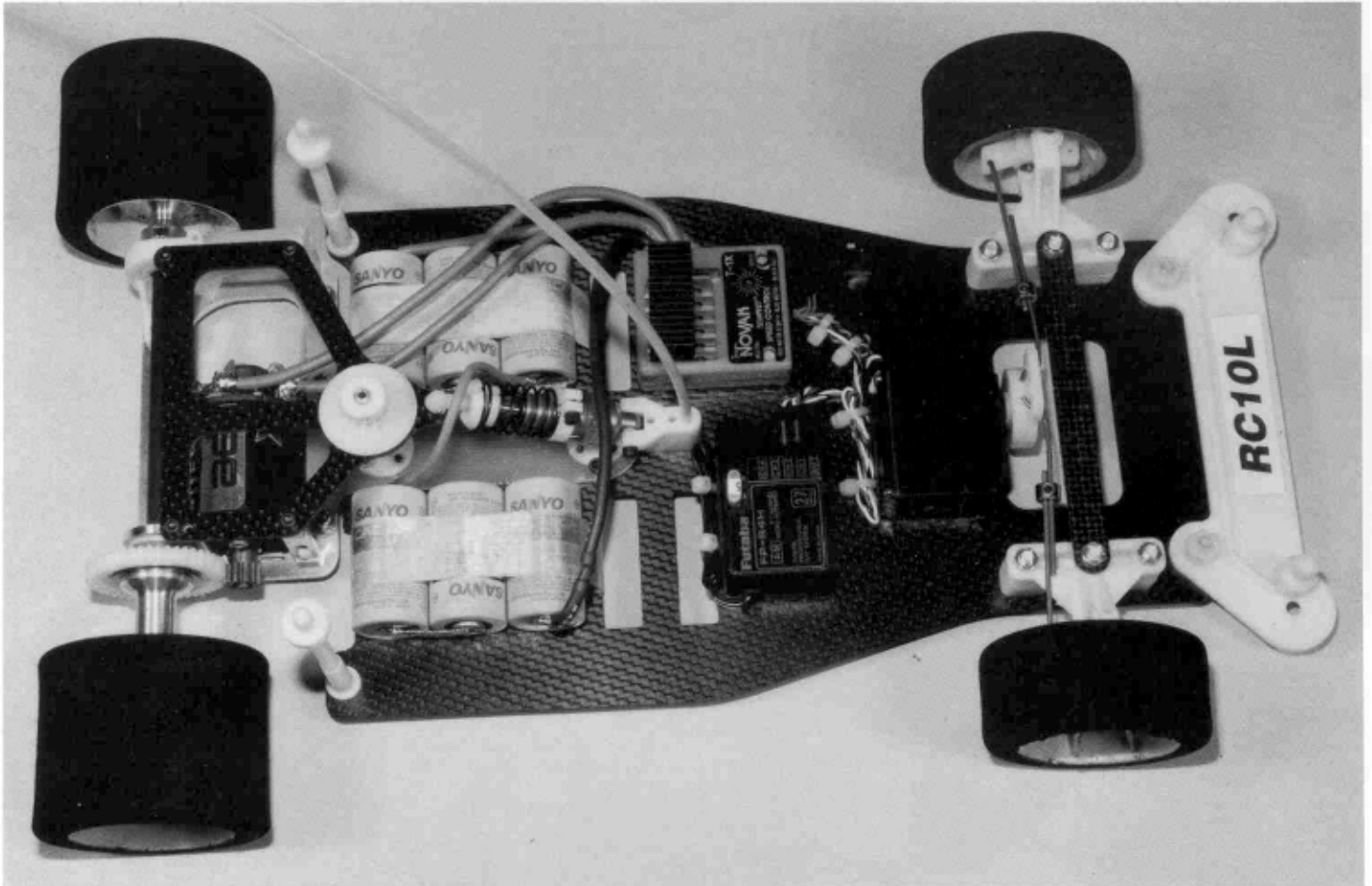

CAUTION

Ni-Cd batteries are susceptible to damage when overcharged at a high rate, and can release caustic chemicals if the overcharge is severe. **Read the battery charging instructions in this manual before attempting to run your car.**

Do not stall the motor under power. If the car stops suddenly on the track, or fails to move forward when you attempt to accelerate (after hitting a wall, for instance), push the throttle control on your transmitter to the brake position immediately and attend to the car. A small rock may have stalled the gears, and if the throttle is left in the "on" position, the result can be a burned-out motor or resistor or electronic speed control unit.

If you run your car to the point where more than one cell in the pack is completely discharged, it is possible to lose radio control of the car before the drive motor stops completely. For this reason you should not operate your car in an area where it could be damaged or cause harm to others, such as near a pool of water or a busy roadway. Usually radio control will be regained as soon as you pull the car from the obstruction and the motor is allowed to free-run. If you still don't have control, then you should turn the switch off.

A partially burned-out or shorted motor can make the car appear to have radio problems. If the car slows down suddenly and the radio acts erratically even with a full battery charge, then the cause is probably the motor. Check the range of the radio. A shorted motor will draw extremely high current even under no-load conditions.

RC10L is a trademark of ASSOCIATED ELECTRICS, INC.
©1989 ASSOCIATED ELECTRICS, INC.

FIRST, A WORD

CONGRATULATIONS! You now have the best 1/10 scale on-road car in the world! The RC10L is based on the design of our Associated RC12L car. As you probably know, the RC12L placed 1st, 2nd, 3rd and 5th at the 1/12 World Championships in Las Vegas, and then followed that up at the 1/12 World Championships in Holland by placing 1st, 2nd, 3rd and 4th!

Those of you who have raced the RC12L will notice its similarity to the RC10L. The basic differences, of course, are that the RC10L is larger, it uses a shock absorber to dampen the rear end, and the rear axle assembly is longer.

Initially we built one prototype car for the ROAR Nationals, where it won the Top Qualifier honors. We then built nine more prototypes for the rest of the Team Associated drivers to run at the ROAR Regionals. With 160 entries, the RC10L took Top Qualifier honors in both classes, won both classes, and placed eight cars in the Stock Main and seven cars in the Modified Main. At its third race ever, at the Los Angeles Velodrome, it set a new national top speed record for 1/10 cars at 56.5 mph! We know you'll like your new RC10L car.

CHASSIS PREP

Fig. 1— There are two RC10L kits made. The #8001, which is a fiberglass chassis kit, and the #8002, which is a graphite chassis kit. Those of you who have the fiberglass chassis can always update to the graphite chassis at a later date. The chassis are fully interchangeable.

Although these instructions show only the graphite chassis (the black one), the fiberglass car is assembled in exactly the same way these instructions show.

To begin, take your chassis, graphite or fiberglass, and notice that the **BOTTOM** of the chassis has the holes countersunk for screw heads. On the **TOP** of the chassis we want to file the eight battery slots at the small angle Fig. 1 shows, so the battery cells will not be against a sharp corner that could possibly cut through the battery sleeve. Lightly file both sides, front and back, of all eight slots so the battery cells have a flat surface to seat against. (Fig. 77 shows how the cells are seated in the chassis.) You'll also want to file the edges of the chassis where the strapping tape holding in the batteries touches the chassis. Just round these corners so they can't cut the tape.

When you're finished, wash off the chassis with running water and dry it with paper towels, and then wash your hands off with soap and water. Dispose of all the filings.

You're now finished with Fig. 1, so put a check mark in the box next to "Fig. 1" to show this step is completed. After you've completed each step from now on, check off its box so you know which part of the assembly is completed. You won't miss any steps this way.

How you assemble your car is going to determine how well your car handles. Take your time. Don't be in a hurry. You won't win a trophy for the fastest assembly of a car. Your best chance to win a trophy is to follow the instructions exactly.

To eliminate confusion, do not open any of the parts bags until we tell you. Other wise you will mix up small washers, screws, springs etc., which will make assembly much more difficult.

We also recommend using a paper plate to hold the parts from each bag. Have a separate plate for pouring the contents of each bag. This will keep the parts from each bag separate and will prevent any parts rolling off the table onto the rug and being lost forever. (It really happens!)

You'll find the photos in the instructions are so easy to follow, that many of you may be tempted to put the car together from the photos alone. However, although you have the best car kit in your hands, if you also want the best-assembled model race car, then you must put it together correctly by following these instructions. Take your time. The better you assemble the car, the better race car you will have.

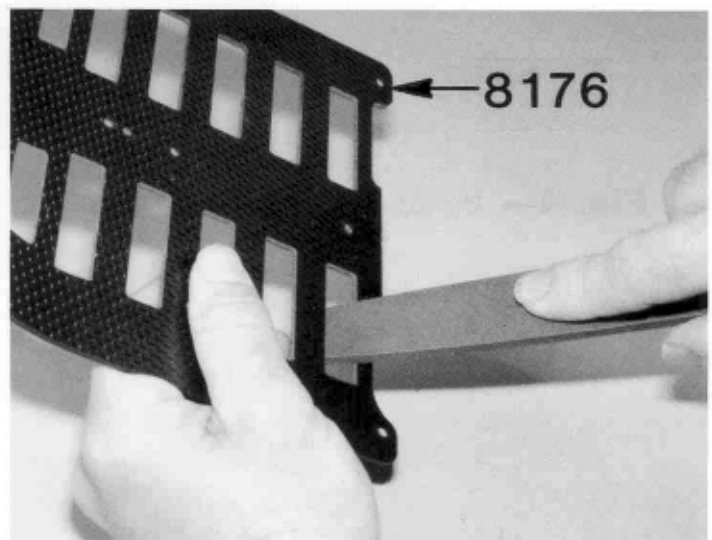

Fig. 1

BUMPER

Fig. 2— Take the chassis and the bumper from Bag #1 and mount the bumper on top of the chassis, as shown at the left half of the photo, with the two short aluminum screws and nylon nuts (displayed on the right side of the bumper). Be careful not to overtighten the screw because you can strip the threads of the nylon nut. When it feels snug, then stop tightening. If you're running the Nissan GTP body, you can install the short body mounts from Bag #2 as shown. Otherwise you must wait until the rest of the car is assembled and install the appropriate body mounts for your particular body. Mount it so the bottom of the body is even with the chassis.

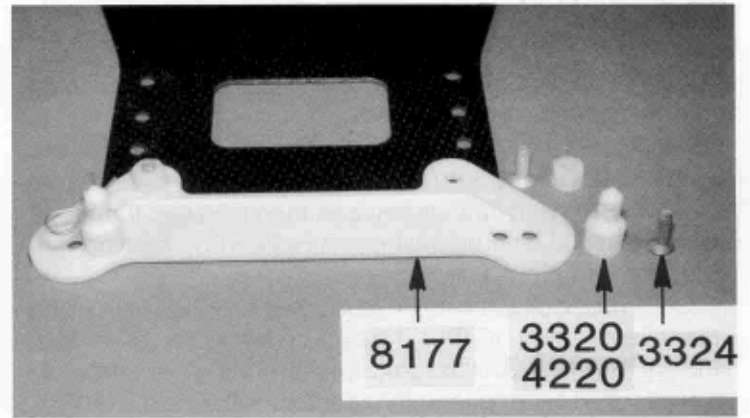

Fig. 2

FRONT END

Fig. 3— Empty Bag #2 into a paper plate. Take one of the #3213 front axles and push in one of the #3214 "E"-clips into the axle groove. The "E"-clips are taped together and can be seen a little better in the photo. Put another clip on the other axle. Now slip one of the small white nylon washers all the way onto the axles and up against the "E"-clip.

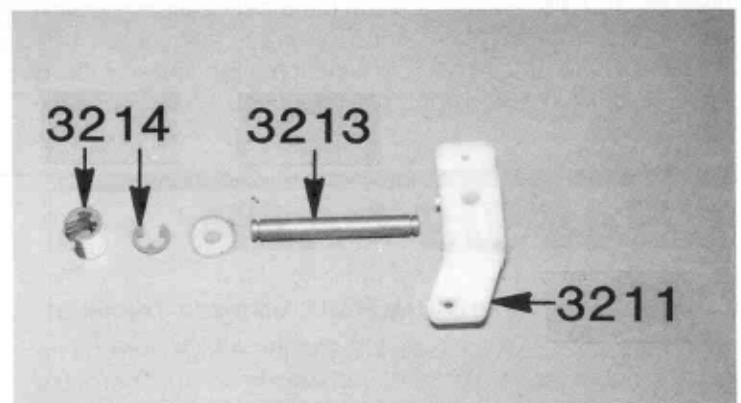

Fig. 3

Fig. 4— The axles should now look like this.

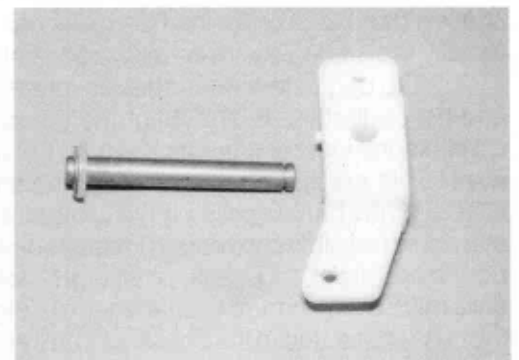

Fig. 4

Fig. 5— Now tap the axles into the #3211 front steering blocks in the direction shown. The axle will go in tight, so support the steering block before driving the axle in. Support it by using a board with a small hole in it, or a vise. Set the block on top of the vise and drive the pin downward through the slightly opened jaws. Assemble both blocks. Your front blocks so far should look as shown.

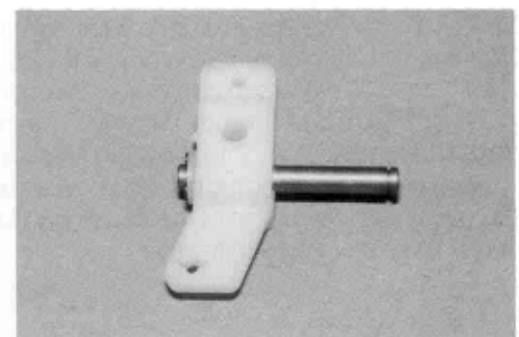

Fig. 5

□ Figs. 6, 7 & 8— Now we're going to join the steering block to the #4115 front suspension arms. Place the steering block in the arm as shown in Fig. 7; place a spring on top of the arm where shown. Slide the #4123 kingpin into the suspension arm holes through the steering block and spring. Now put an "E"-clip into each of the two grooves in the kingpin. It's easier to put in the clip by the spring first, and then to put the clip on the bottom of the steering arm last. It will be a close fit but they will go on. Make sure they're securely in the grooves. Pushing them in with a small screwdriver seems to work best. Assemble both blocks.

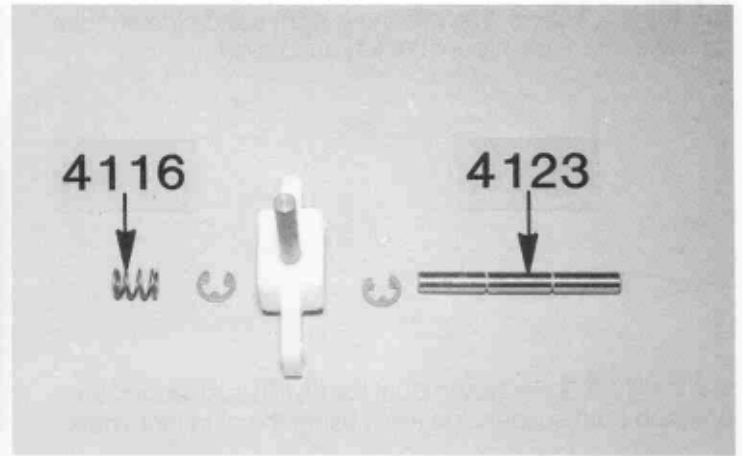

Fig. 6

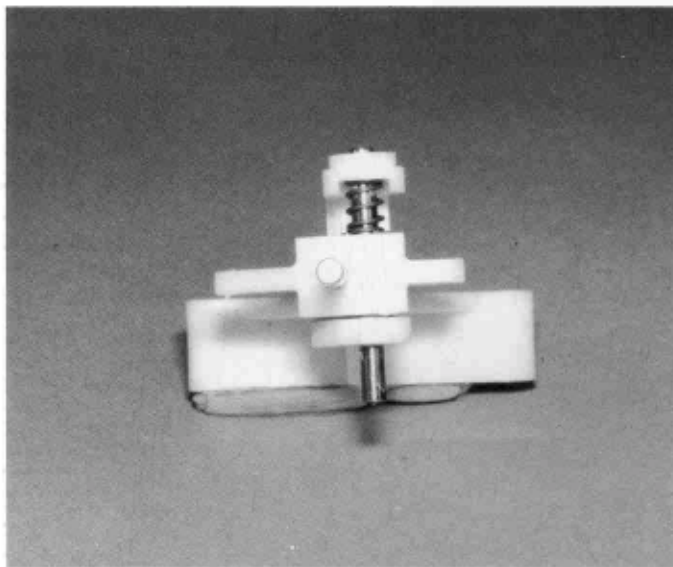

Fig. 7

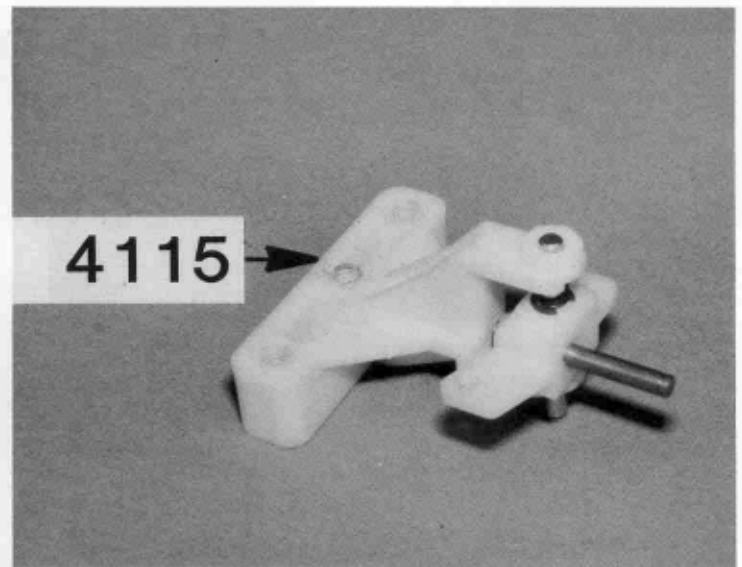

Fig. 8

□ Fig. 9— Now we mount the suspension arms to the chassis. The 1/4" thick spacer goes on the chassis first, and then the suspension arm goes on top of the spacer. Make sure you've got the left hand side of the arm on the left hand side of the car and the right hand side arm on the right hand side, as in Figs. 9 (right hand side) and 11 (both sides).

Use three long aluminum screws to mount each arm. Screw in and tighten the front and back screws, but leave the center screw loose. The kit also includes tapered camber shims, but it's best to start without any camber on this car.

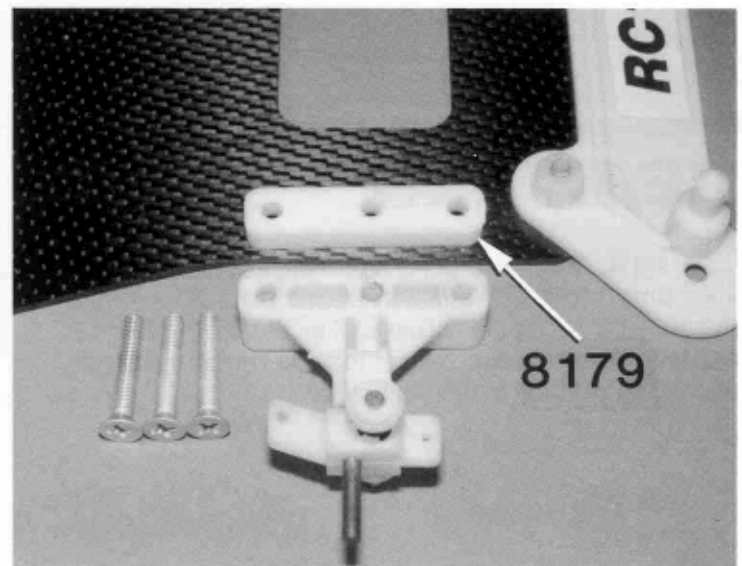

Fig. 9

Fig. 10— The mounted right hand side should look like this. Now mount the left hand side.

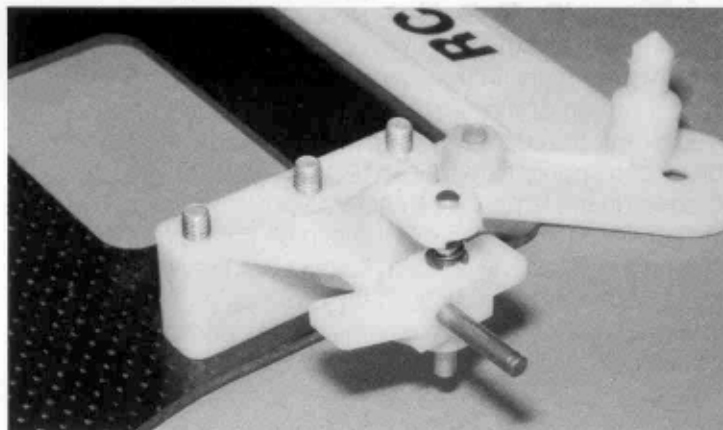

Fig. 10

Fig. 11— Now mount the #8178 suspension arm brace to both suspension arms using the aluminum nuts.

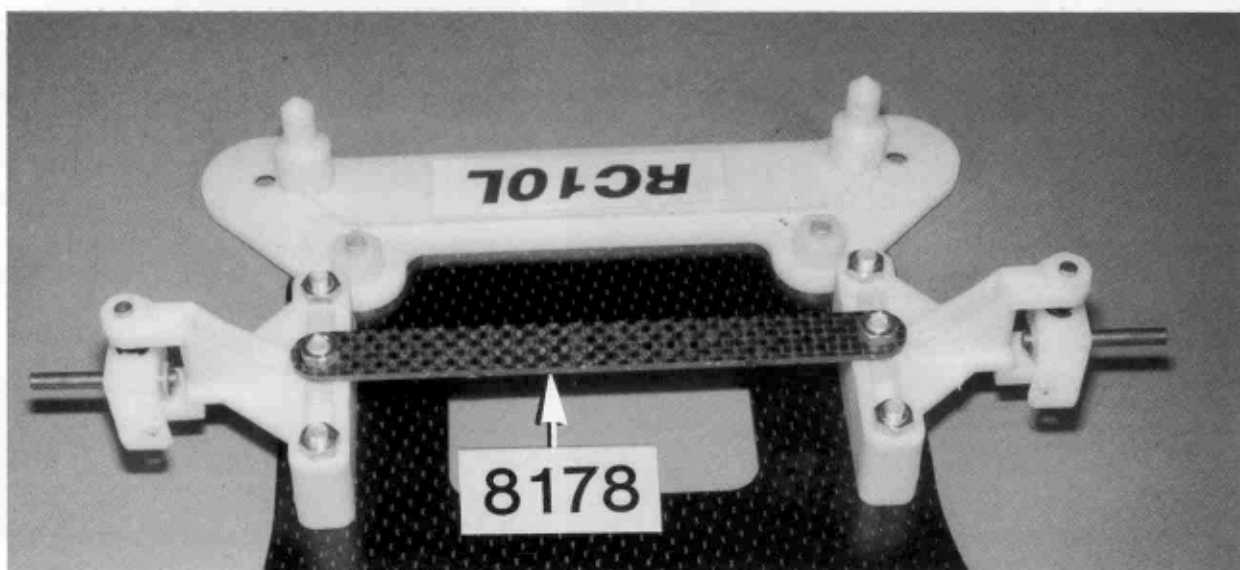

Fig. 11

REAR END

Figs. 12 & 13— From Bag #3 take the #4336 steel pivot ball and the #4335 plastic pivot socket, and place the ball in one side of the socket, as shown in Fig. 13, and then place the other half of the socket onto the ball and align all four screw mounting holes.

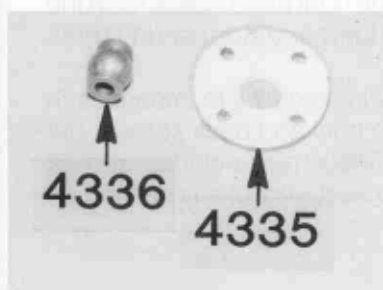

Fig. 12

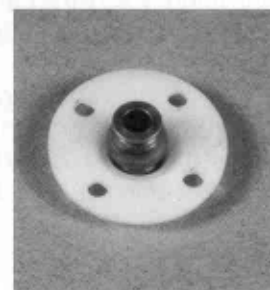

Fig. 13

☐ **Figs. 14, 15a & 15b--** Mount the socket assembly onto the #8190 T-bar with the four screws shown in Fig. 14. Do not overtighten. If this ball is tight in the plastic, it's okay; it doesn't swivel. (Fig. 15a shows the top view; Fig. 15b shows bottom view.)

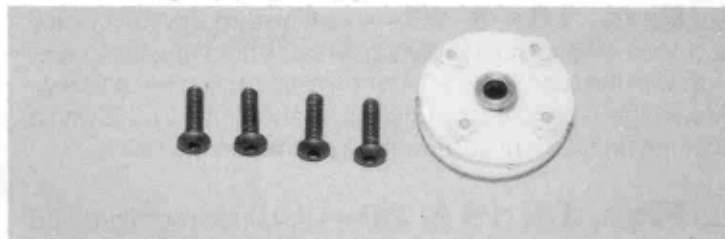

Fig. 14

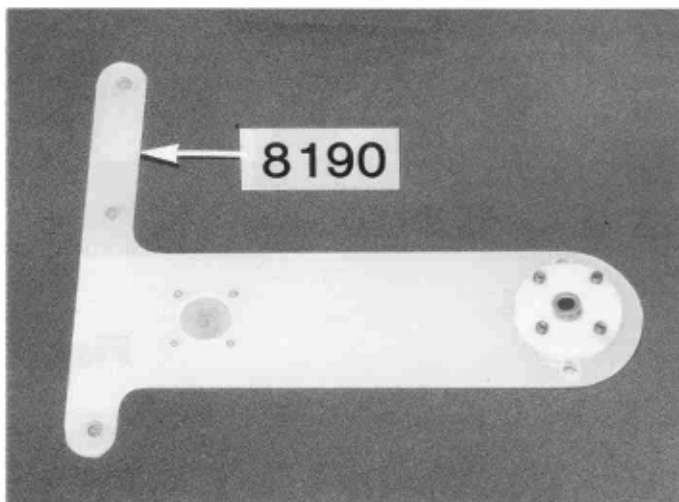

Fig. 15a

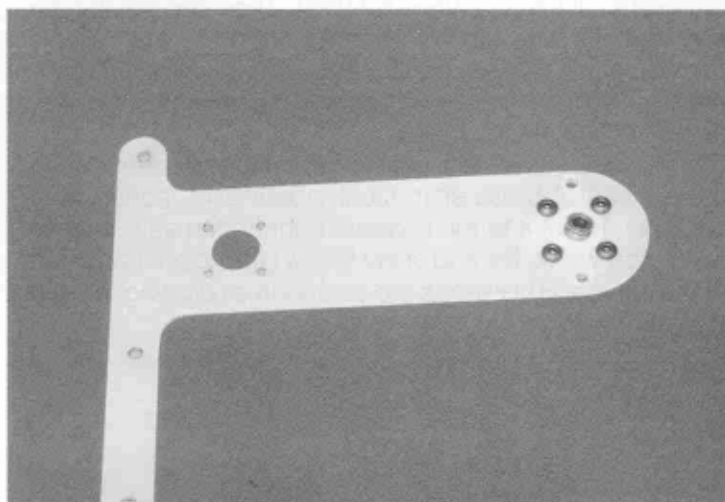

Fig. 15b

☐ **Fig. 16—** Now assemble and mount the second, rear socket assembly like you did the first one. Except in this socket, the ball **MUST BE VERY FREE, BUT NOT LOOSE**. Now see if the ball is **PERFECTLY FREE**. If it is, good, leave it as is. If it's not, there are two things you can do. You can unscrew all four screws one half turn. But the best thing to do is to take the ball back out and polish it. You can do this by placing a 4/40 screw in the ball and securing it with a nut and turning the screw in a drill press, polishing the ball with crocus cloth or #660 wet or dry sandpaper. Re-install the ball and make sure it's **PERFECTLY FREE**, but **NOT LOOSE**.

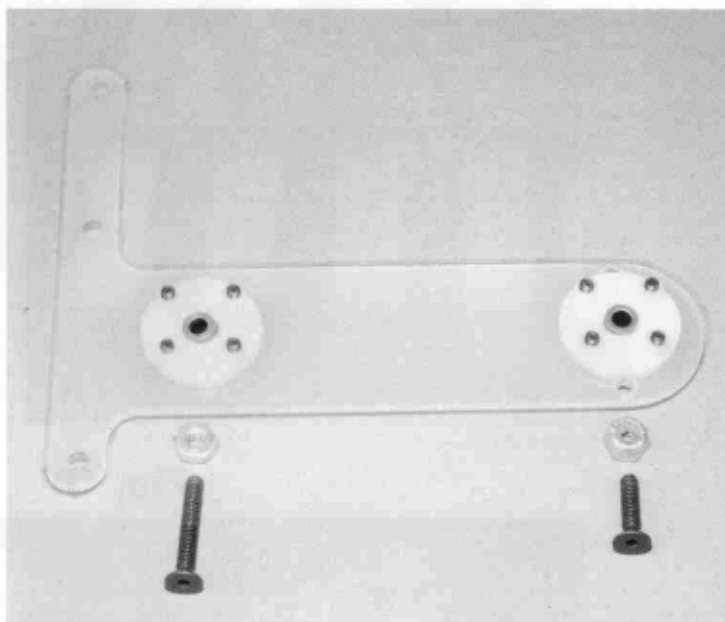

Fig. 16

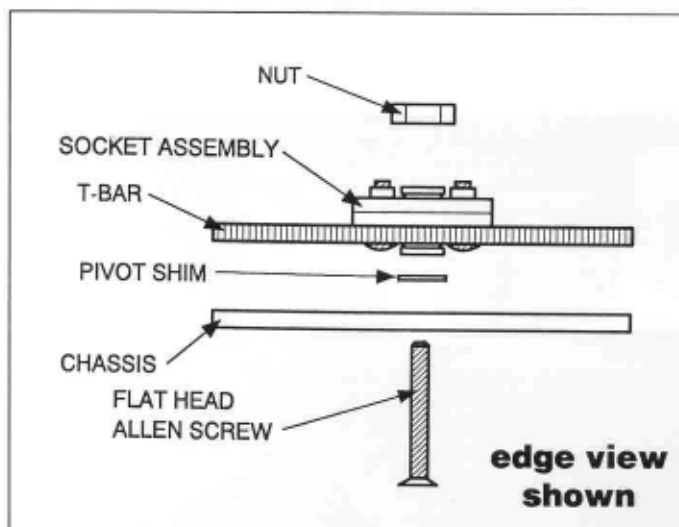

Fig. 16a

☐ **Figs. 16a & 17**—Push up through the chassis the short 4/40 flat head allen screw in the front and the longer screw in the rear. Slide a T-bar pivot shim onto each screw. Mount the T-bar onto the chassis as shown in Fig. 17, with a locknut on the front screw and plain nut on the rear.

☐ **Figs. 18, 19 & 20**— Install the two allen head "tweak" screws in the front of the T-bar, as shown. TIGHTEN THESE SCREWS ONLY UNTIL THEY JUST TOUCH THE CHASSIS. DO NOT OVERTIGHTEN. They should also be screwed in evenly, so that when you're done, the T-bar is parallel to the chassis, and it's not twisted in relation to the chassis. We'll talk more about actually tweaking the car later at the back of the manual.

Racer's Tip: Most of the Expert Class racers like to cut a piece of brass shim stock about 5/16" square and contact cement it to the chassis, right underneath the two tweak screws, so the end of the screw hits the brass instead of the chassis. This keeps the screws from digging into the chassis itself.

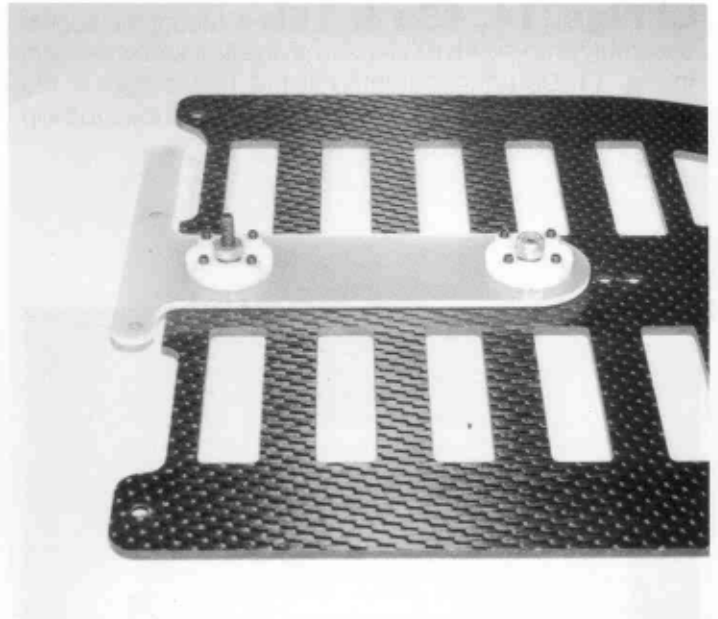

Fig. 17

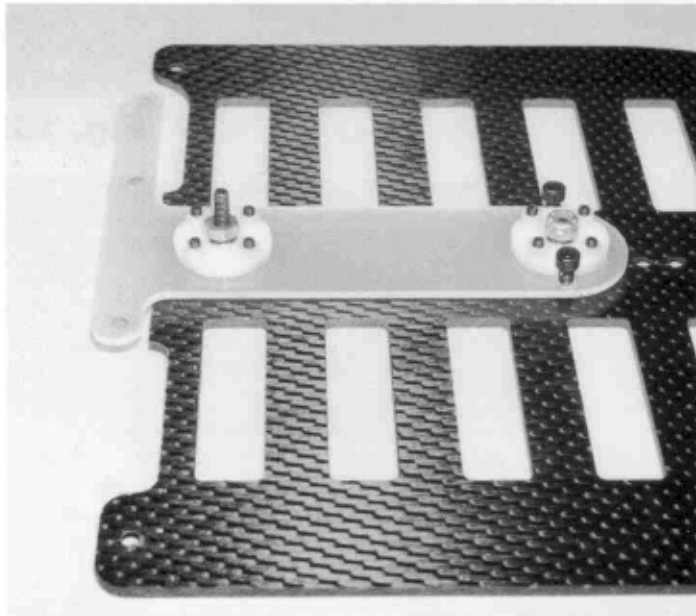

Fig. 18

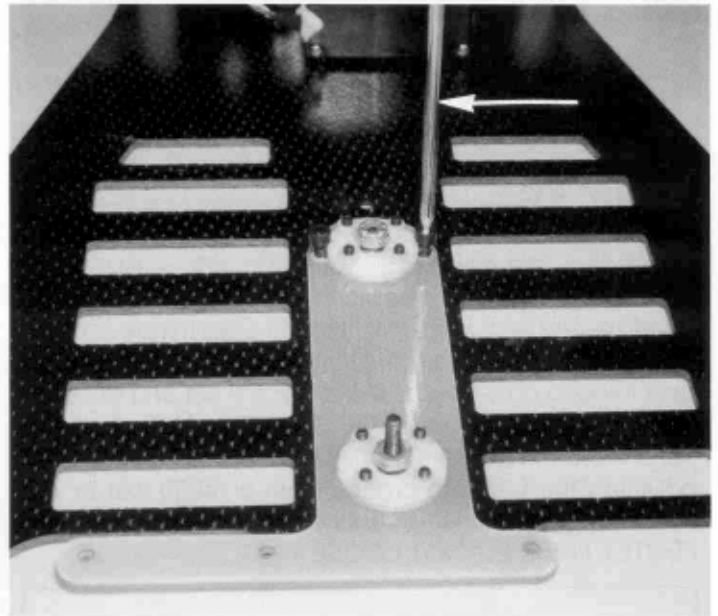

Fig. 19

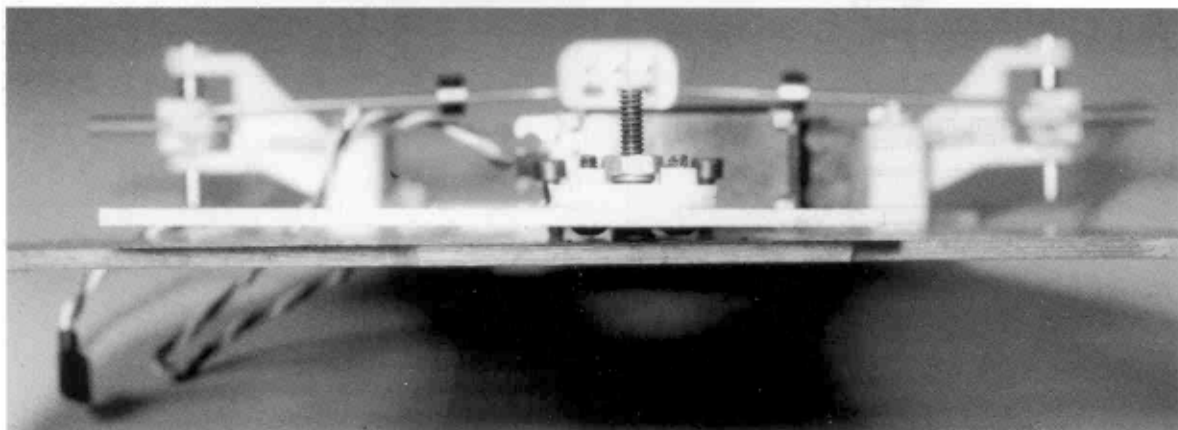

Fig. 20

□ **Fig. 21**— Install and tighten the #4337 aluminum tube.

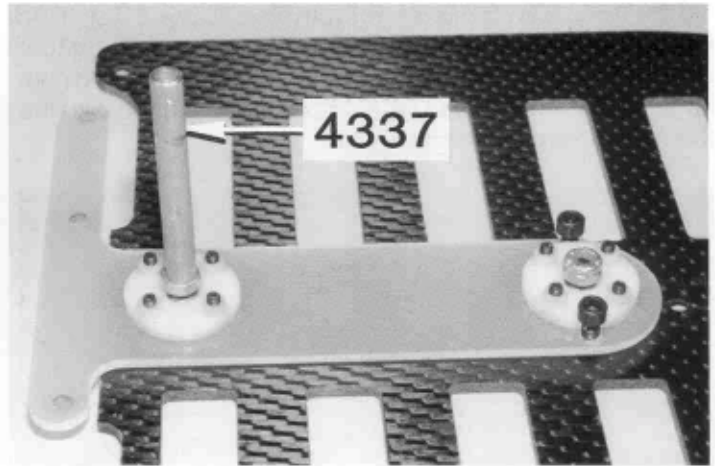

Fig. 21

□ **Figs. 22 & 23**— From Bag #4 remove the #8184 shock/antenna mount and carefully trim off the small round shock bushing and save it for the shock installation (Figs. 64 & 65). Install the #8184 shock/antenna mount with the two allen flat head screws.

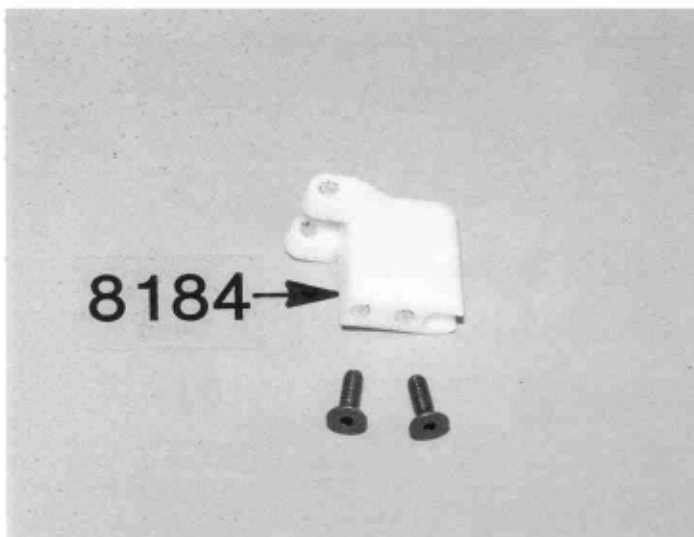

Fig. 22

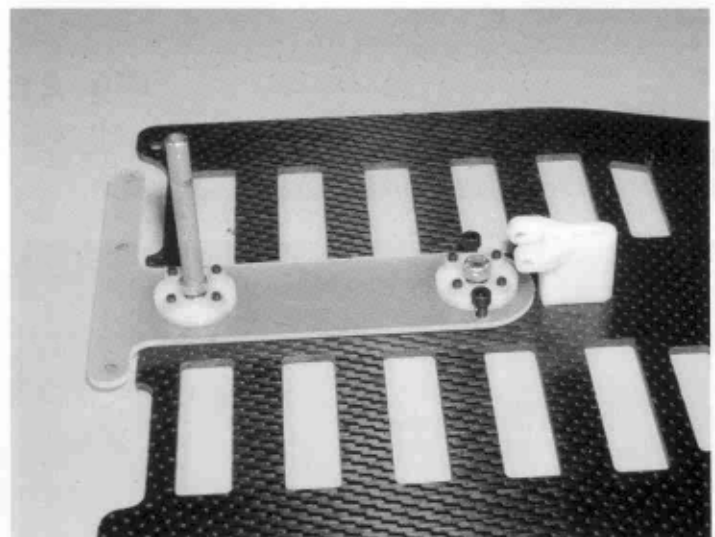

Fig. 23

□ **Figs. 24 & 25**— Install the #8185 rear body mounts on the chassis using the allen screws. Install the body mount collars with a set screw.

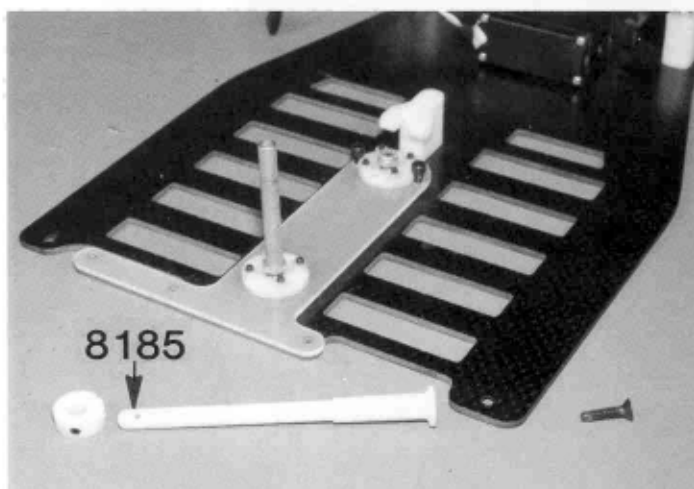

Fig. 24

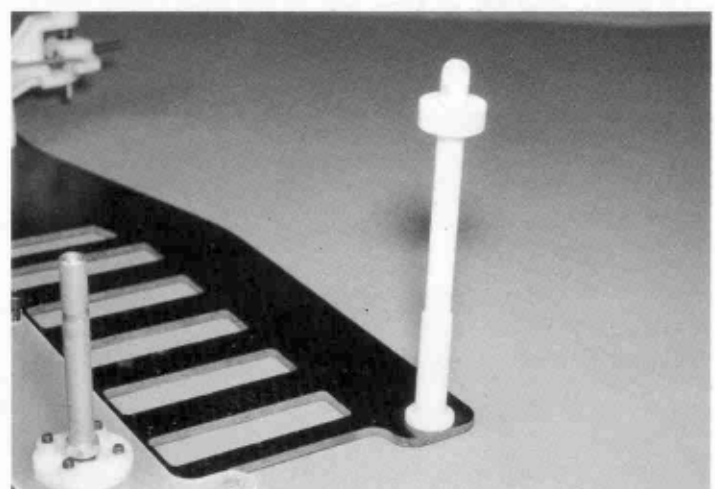

Fig. 25

☐ **Figs. 26 & 27**— From Bag #5, we'll install the #8202 lower brace. First place the #8203 fiberglass spacer UNDERNEATH the T-bar. Then place the #8202 aluminum lower brace UNDERNEATH the spacer. Assemble with the three allen screws and locknuts.

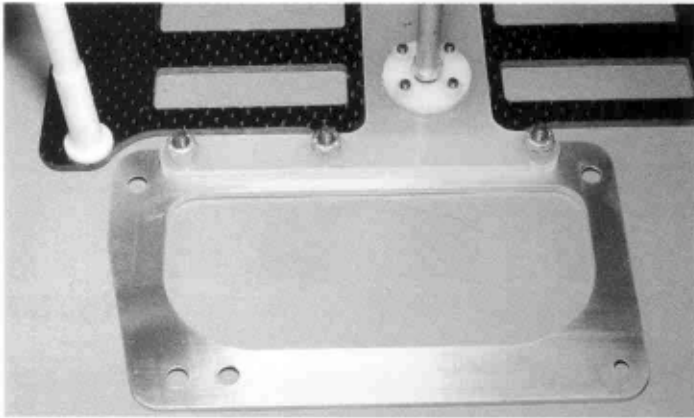

Fig. 27

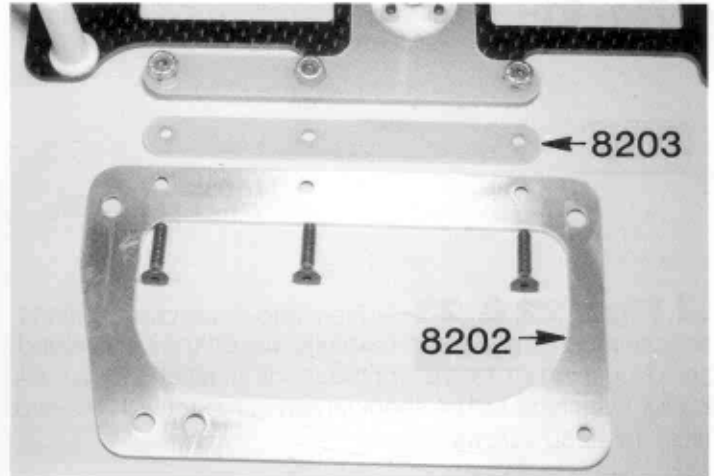

Fig. 26

☐ **Figs. 28 & 29**— Mount the #4345 left hand plastic bulkhead to the lower brace using the three #3324 aluminum screws. Do not overtighten.

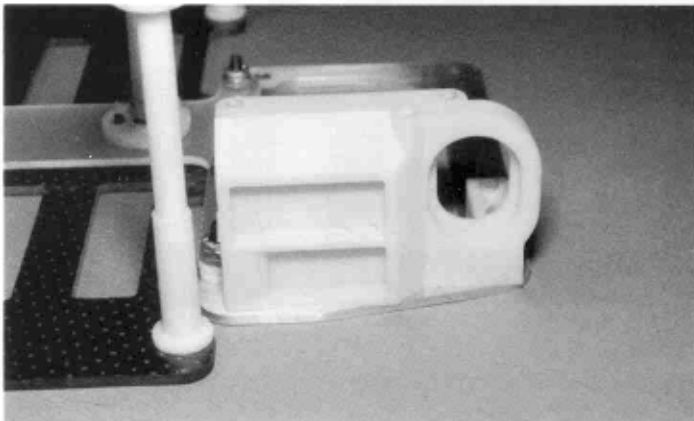

Fig. 29

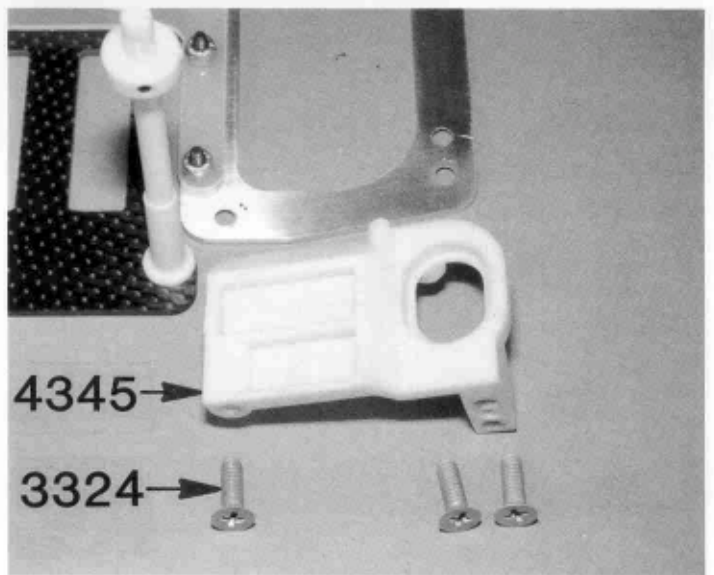

Fig. 28

☐ **Figs. 30 & 31**— Mount the #4347 right hand aluminum bulkhead to the lower brace with one allen screw and one Phillips screw.

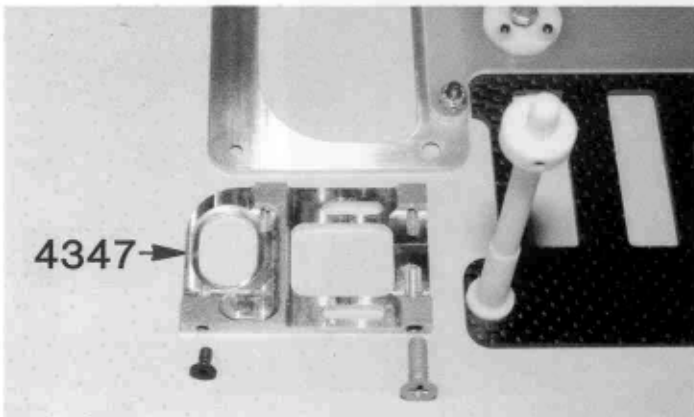

Fig. 30

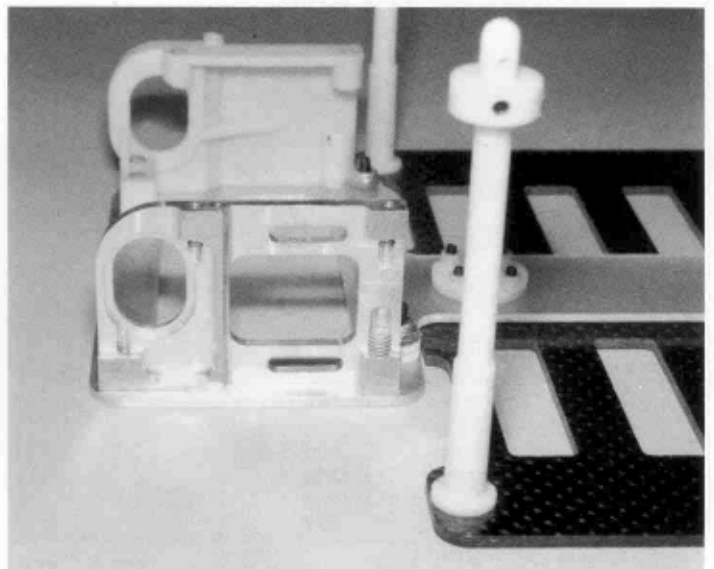

Fig. 31

□ **Fig. 32**— The bottom side of the car should look like this now.

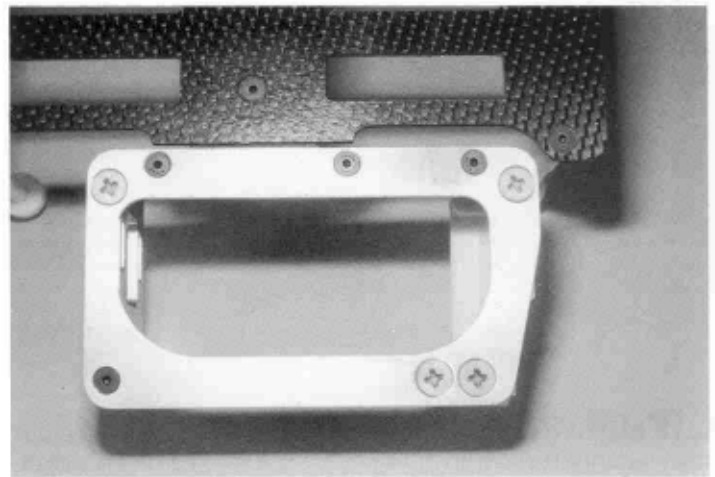

Fig. 32

□ **Figs. 33 & 34**— From Bag #6, slide the #4340 dampner washer, #4341 spring and #4338 collar with set screw onto the aluminum tube. The collar goes on first, then the spring and then the dampner washer with the smooth, flat side up. Mount it low; later we'll adjust it.

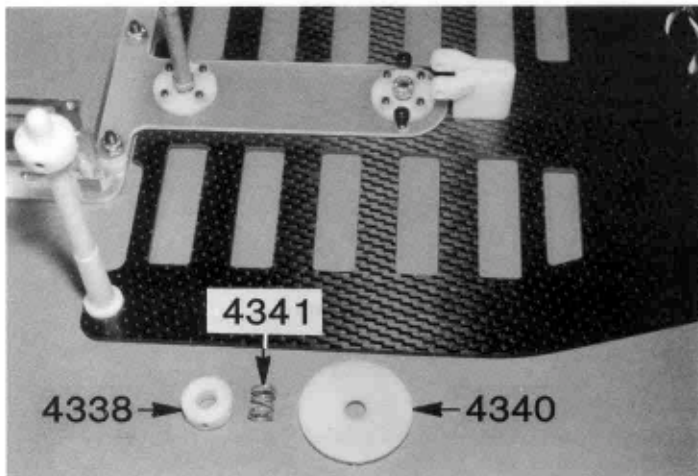

Fig. 33

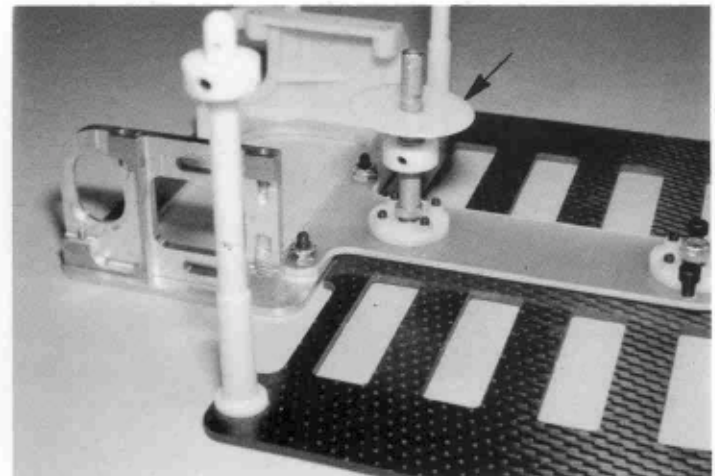

Fig. 34

□ **Figs. 35 & 36**— The arrow is pointing to the upper bracket where the dampner washers ride. Racer's Tip: The Expert Class racers will take some #600 grit wet or

dry sandpaper and sand all the edges smooth here, so that the dampner washers slide freely over the bracket. Take the #6270 steel ball from Bag #4 and mount it into the #8201 graphite upper bracket with the nut.

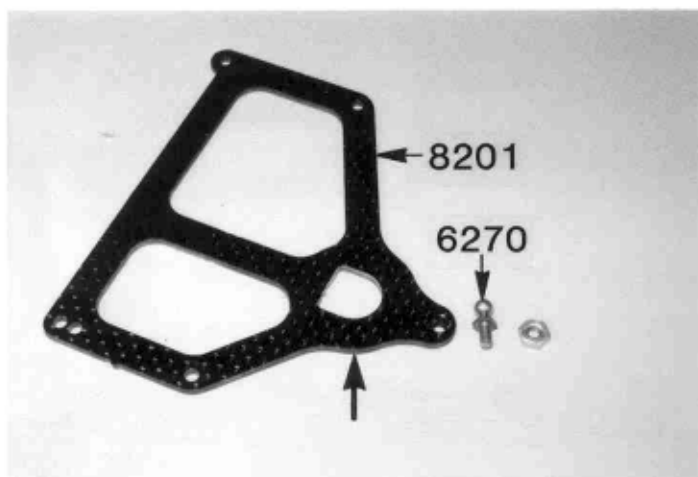

Fig. 35

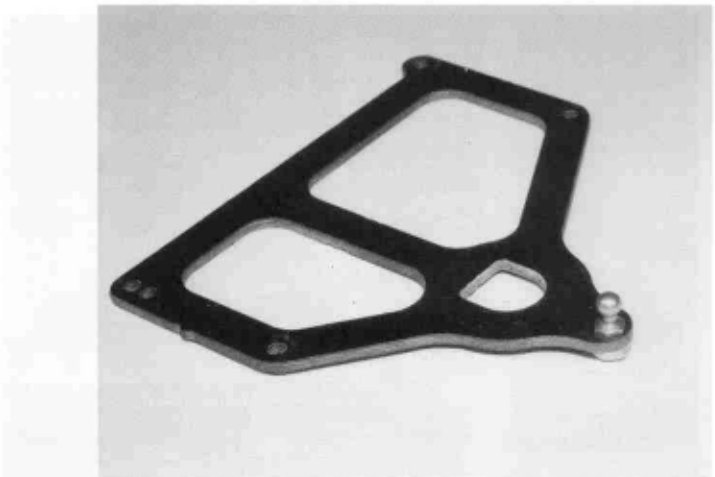

Fig. 36

Fig. 37— Mount the #8201 graphite upper bracket onto the rear end with the four allen head screws.

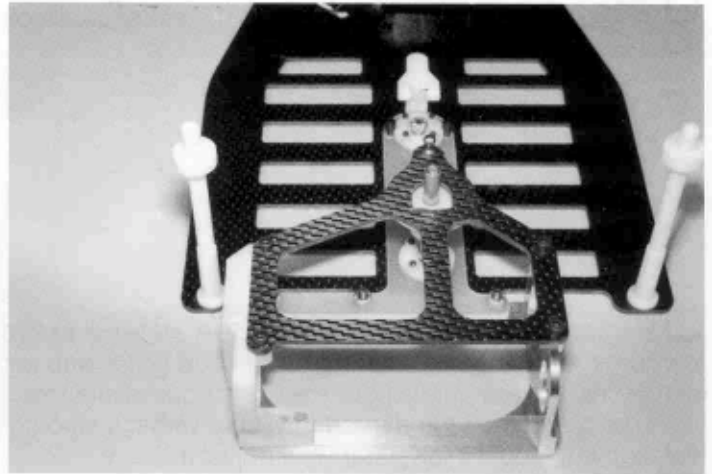

Fig. 37

Figs. 38 & 39— Install the dampner washer on the aluminum tube with the smooth side towards the bracket. Then slip on the spring and collar so it looks as in Fig. 39.

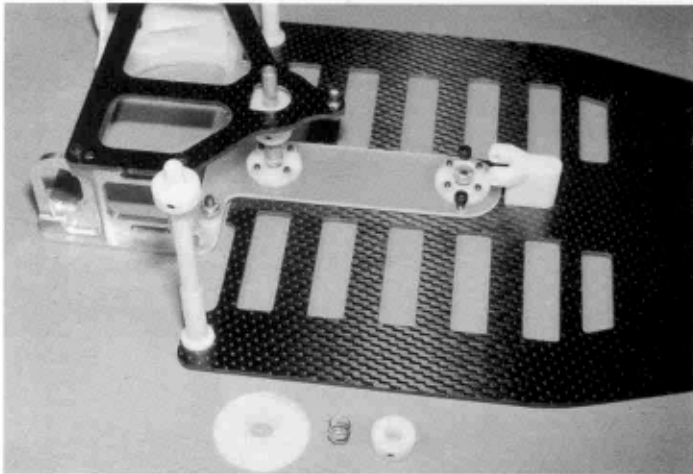

Fig. 38

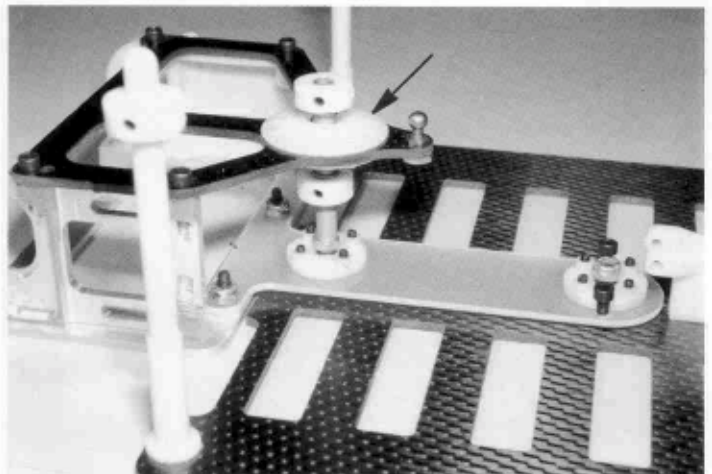

Fig. 39

Fig. 40— After the car is completely assembled, the two collars should be adjusted so both springs are collapsed exactly the same amount—about a .200" gap at each spring. We'll have to adjust this later when we come to Fig. 77. Do not check off the square yet.

Figs. 41 & 42— Take the #4350 plastic axle bearing height adaptors. This is the pair with the holes most offset, the ones which allow the bearings to be mounted the highest in the car. Install two #897 ball bearings in the two adaptors. Then install the two bearing adaptors in the bulkheads.

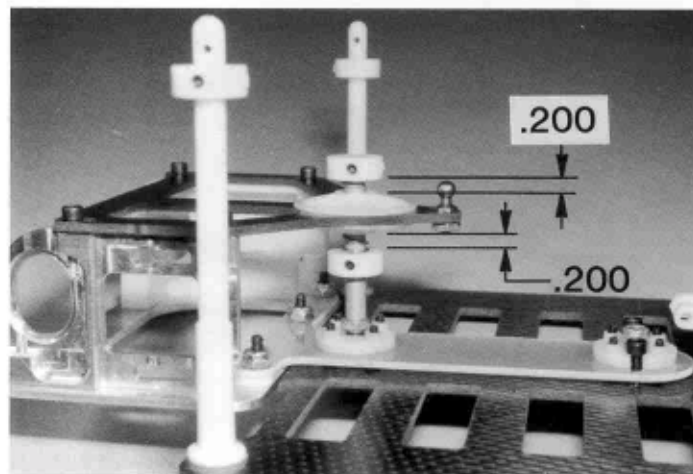

Fig. 40

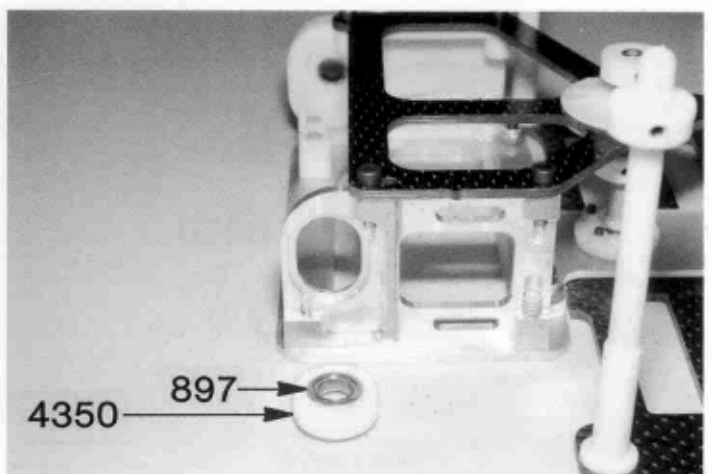

Fig. 41

DIFFERENTIAL

□ **Fig. 43**— From Bag #7, remove the #6653 plastic spur gear and eight of the #3432 differential balls and push them into the gear. Now place a small dab of lube on each ball from the Associated diff lube #6636. USE THIS DIFF LUBE ONLY. NEVER USE ANY OTHER. THERE IS NONE BETTER. Other types of lubes will only make the differential slip.

□ **Figs. 44 & 45**— We're ready to build the rear axle assembly. Slip one of the #6625 differential drive rings onto the #8212 axle, as shown in Fig. 44. Racer's Tip: The Expert Class racers will put a drop of Super Glue, like ZAP or Hot Stuff, where the arrow is pointing to glue the drive ring to the aluminum hub.

On to Fig. 45. Now slip the spur gear and the other drive ring on. Now, from Bag #8, push the two #897 ball bearings into the #8211 aluminum diff spacer and then slip the diff spacer onto the axle. You'll have to center the outer drive ring so it will align with the diff spacer.

Now slide on the aluminum dif thrust collar, small hole first, then the two belleville washers, then the nut, with both washers bulging toward the nut. Just tighten the nut a little bit to hold all the parts together. We'll adjust it later when we come to Fig. 49.

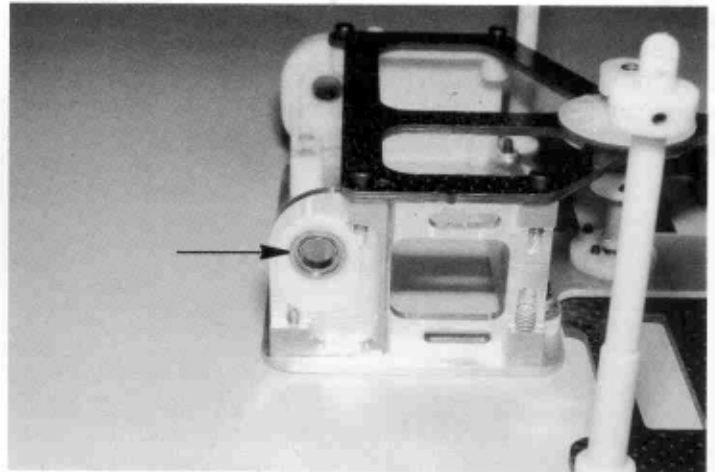

Fig. 42

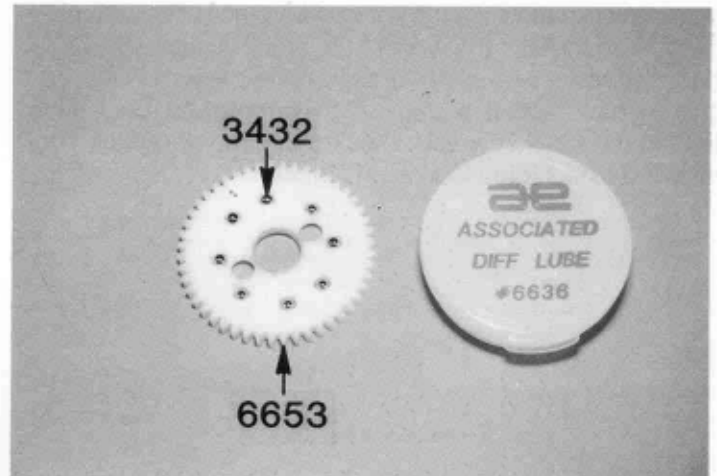

Fig. 43

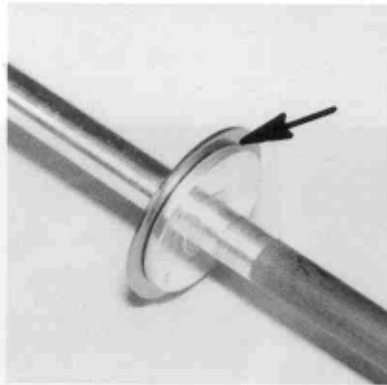

Fig. 44

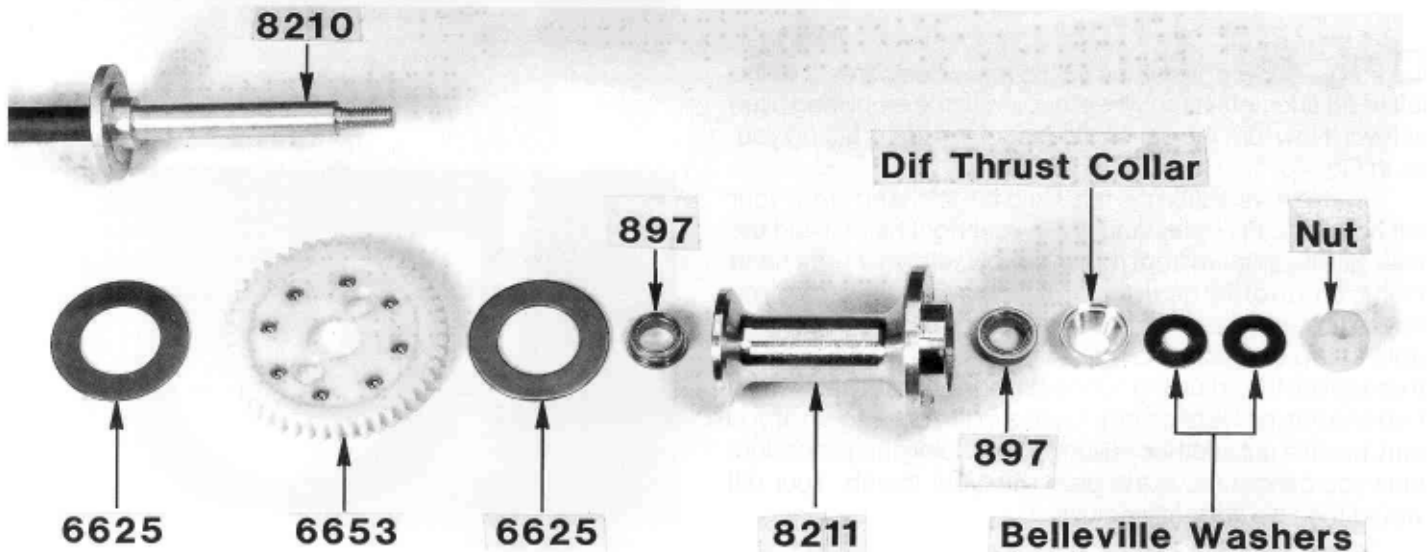

Fig. 45

Fig. 46— On the left hand side of the axle, slide one of the smooth washers onto the axle first and then the other blue thrust bearing. Push them all the way over against the aluminum axle hub. Then slip the axle through the rear end ball bearings from the right hand bulkhead side.

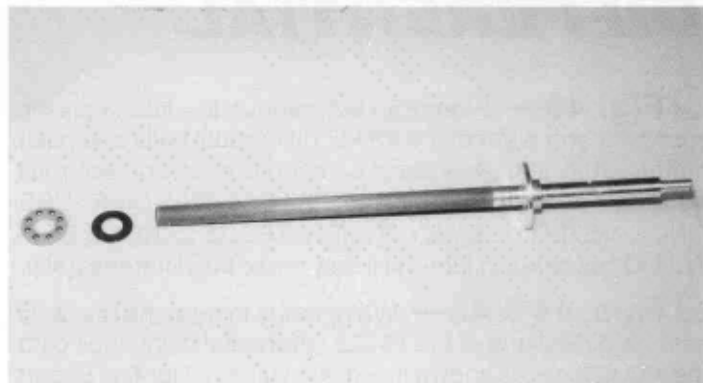

Fig. 46

Figs. 47 & 48— Now slip a blue thrust bearing onto the axle, then another smooth washer. Slide the #8212 left hand wheel hub onto the axle and lightly tighten the set screw. Now remove the wheel hub and file a small flat spot on the axle shaft where the set screw mark is. This will make it easier to remove the wheel hub later. Reinstall the wheel hub. Adjust the side end play so the axle can turn freely. You should have about a paper's thickness end play. Now tighten the set screw and check again the end play. Your installed axle should look as in Fig. 48.

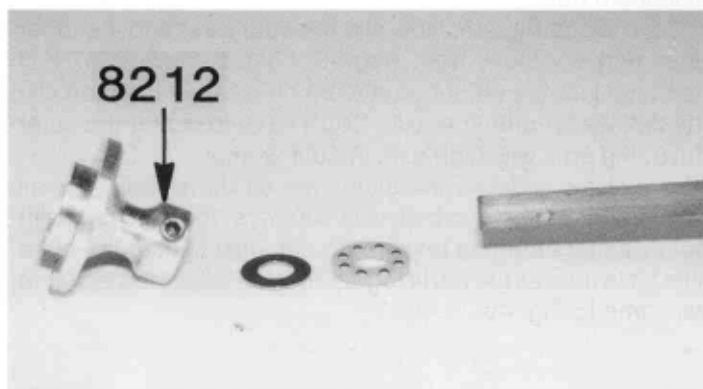

Fig. 47

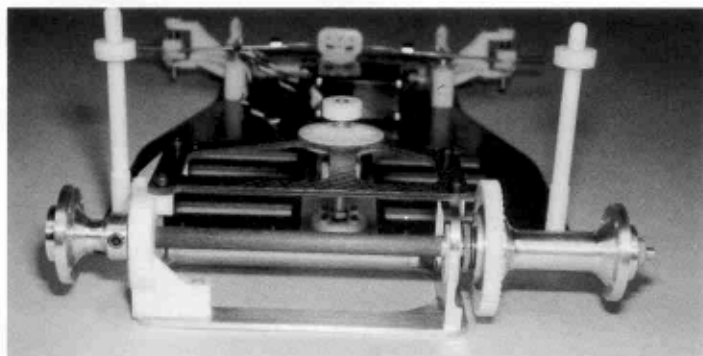

Fig. 48

Fig. 49— Install the #8165 rear wheels/tires onto the left hand and right hand wheel hubs with the eight long allen screws. Now turn the car so the rear of the car is facing you, as in Fig. 48.

Now we adjust the diff. Hold the left hand tire in your left hand and the right hand tire in your right hand. Hold the tires still; keep them from rotating. Now with your right hand thumb on top of the gear, try to rotate the gear forward. If you haven't over-tightened the diff adjusting nut, you should be able to slip the gear and make it rotate. If the gear rotates, then tighten the adjusting nut inside the right hand rear wheel hub one flat (or 1/6 of a turn). Try to slip the gear again. If you can, turn the nut another 1/6 turn. Keep doing this procedure until you cannot move the gear with your thumb. Your diff would then be correctly adjusted.

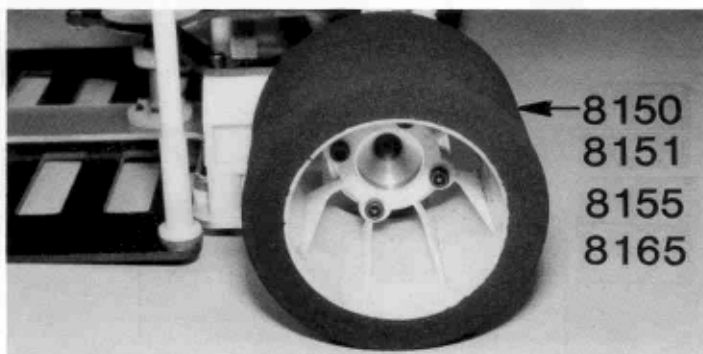

Fig. 49

FRONT WHEELS

❑ **Figs. 50 & 51**— We'll install the front wheels now. First look at the center of the front wheels, where the ball bearings go in. You'll notice the wheel is shaped differently where the ball bearings go in. The smooth side is the outside. The side that is indented for the ball bearing is the inside. Push the four ball bearings into the wheels.

As shown in Fig. 50, slip one of the small plastic washers onto each axle. Then slip the wheel on, then another plastic washer, then an "E"-clip.

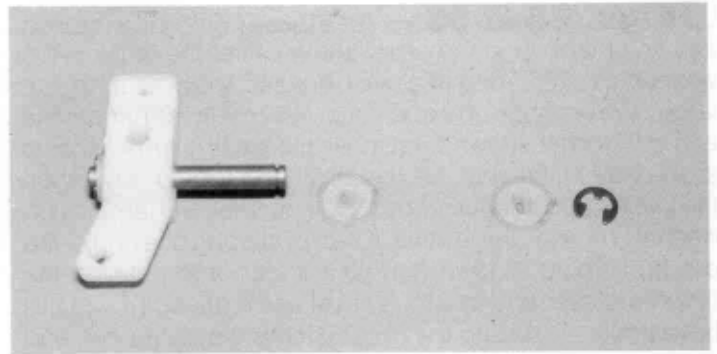

Fig. 50

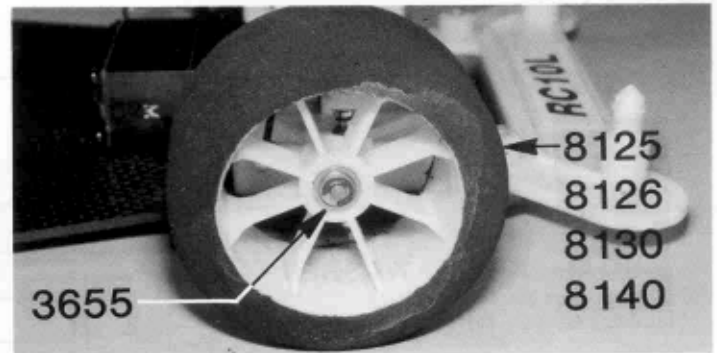

Fig. 51

SHOCK MOUNT

❑ **Fig. 52**— From Bag #4, take out the #6464 piston and #6461 shaft.

❑ **Fig. 53**— Install one "E"-clip on the shaft as shown.

❑ **Fig. 54**— Slip the piston on and install the other "E"-clip. Make sure both "E"-clips are fully seated in the grooves.

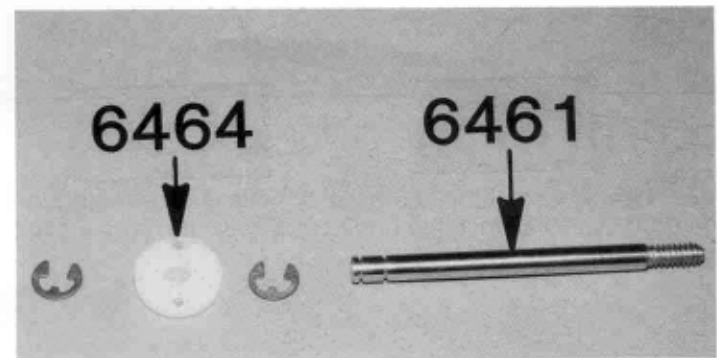

Fig. 52

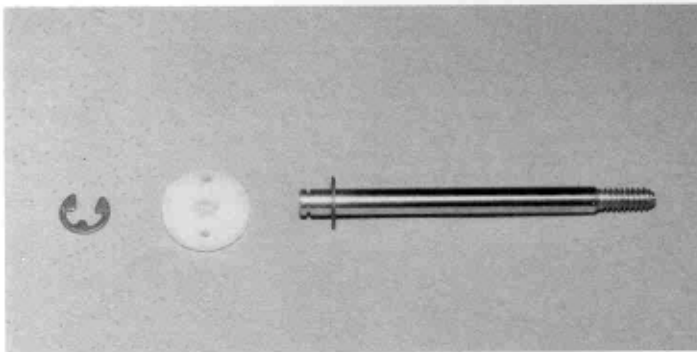

Fig. 53

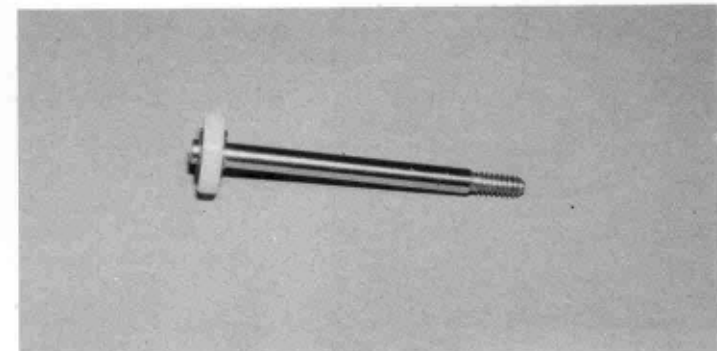

Fig. 54

□ **Figs. 55 & 56**— Take these parts out of the Bag and line them up in the order shown. First the small nylon washer, a red "O"-ring, the nylon spacer, a red "O"-ring, the large nylon washer, and a "C"-clip. Now push the parts in the end in the order shown: First, push the small nylon washer in all the way to the stop. Next push in one red "O"-ring, then the nylon spacer, another red "O"-ring, then the large nylon washer. Then the large inner "C"-clip, starting one end of the clip in, holding it down with your finger, and pushing the other end over and in with a small screwdriver. (If you still have trouble installing the clip, try it this way: start one end of the clip in and hold it down with your left thumbnail. Now start working your right thumbnail around, pressing the ring into the hole as you go. By the time you get to the other end of the clip it will snap into the groove.)

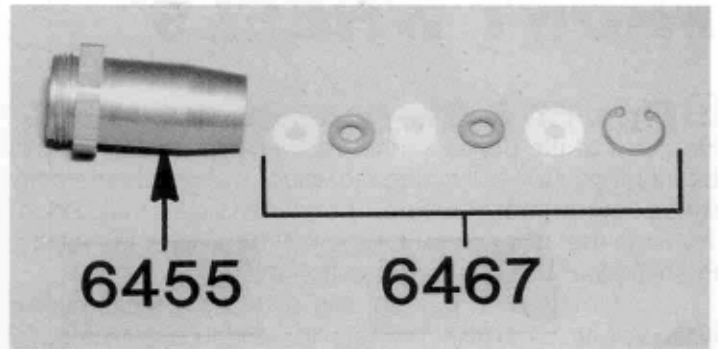

Fig. 55

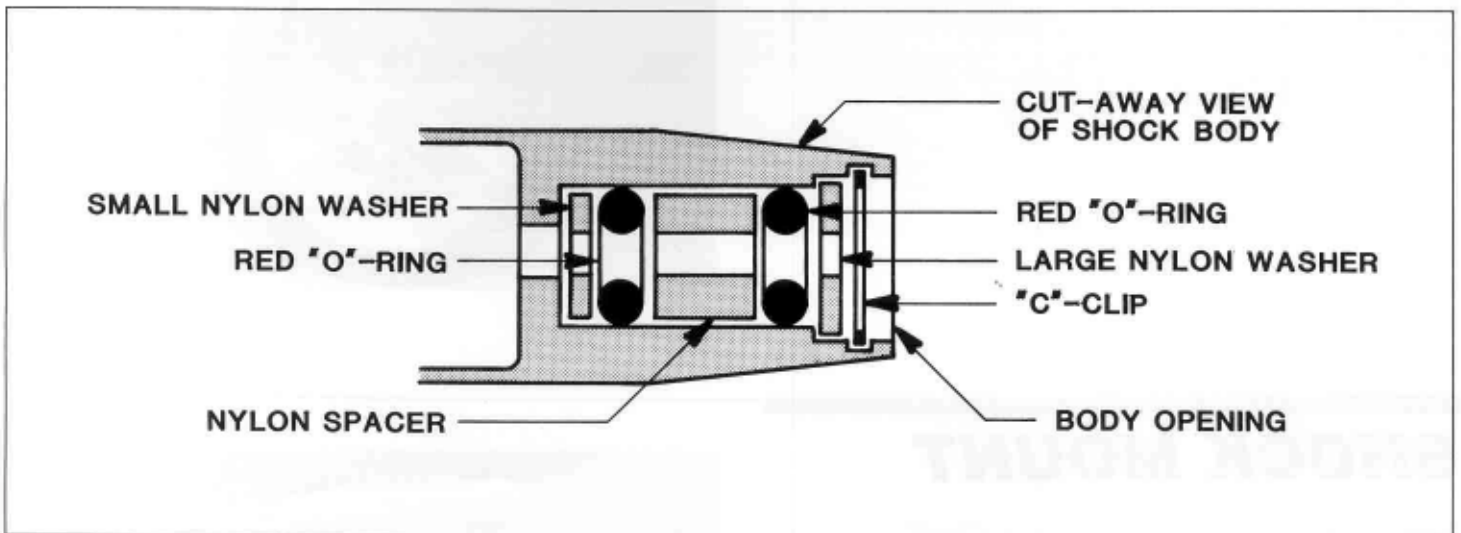

Fig. 56

□ **Fig. 57**— Make sure the "C"-clip is fully seated in the groove as shown in the photo, otherwise the shock can come apart.

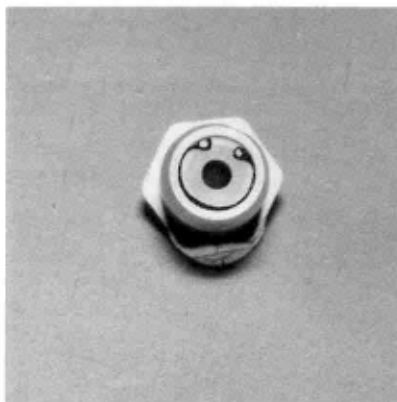

Fig. 57

□ **Fig. 58**— Hold the shock body upright and put at least five drops of oil in it. We want the oil to run down inside and lubricate the "O"-rings. For you serious racers, Associated also has silicone shock oil, which is the best available

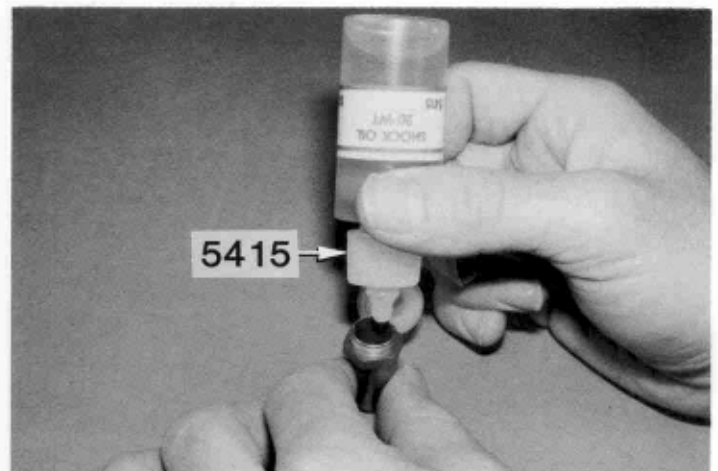

Fig. 58

☐ **Fig. 59**— This looks like a simple step, but it is very important that it be done with the utmost care. Coat the shaft completely with the shock oil. Now slip the shaft into the shock body and through the "O"-rings. Be careful to push the shaft through the "O"-rings slowly, because you don't want to cut or scratch the "O"-rings, otherwise your shock will leak. Pull the shaft all the way through.

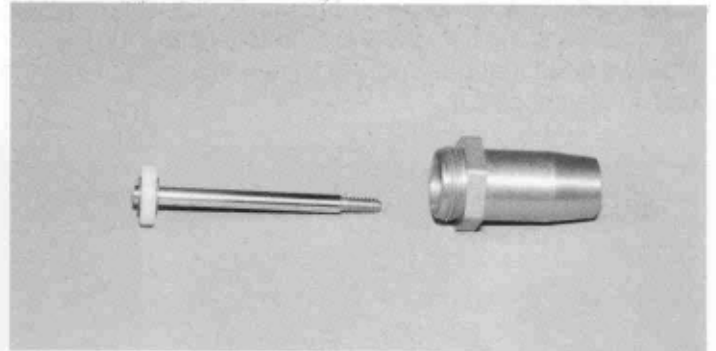

Fig. 59

☐ **Fig. 60**— Now hold the shock upright and fill it with the 20 wt. oil to the top of the shock body.

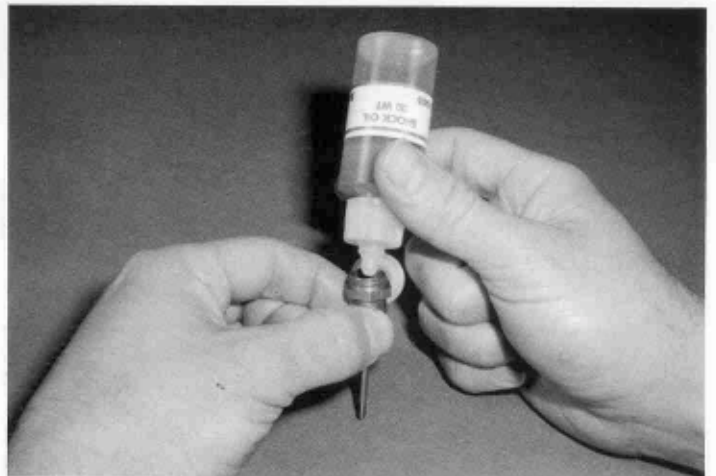

Fig. 60

☐ **Fig. 61**— Slip the nylon gasket over the threads on the shock body and screw the #6463 cap on the body. Place a small screwdriver or allen wrench through the cap hole and tighten the cap snugly. Do not overtighten.

☐ **Fig. 62**— This is the order in which the spring assembly ends up on the shock. However, we'll install them in a different order from that shown. First slide the nylon spacer on the shaft to just below the threads. Now take a needle-nose pliers and hold the shock shaft right next to the threads. Be careful not to hold any portion of the shaft which goes into the body. If you do, you'll scratch the shaft and the shock will leak oil. Now screw the plastic ball cup all the way onto the threads until it bottoms out. Put the pliers away.

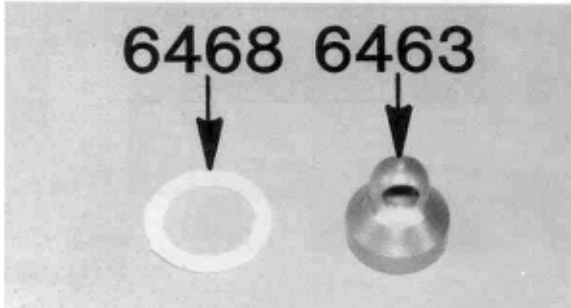

Fig. 61

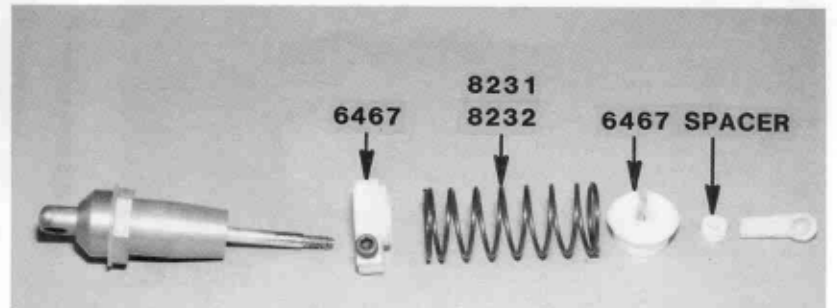

Fig. 62

Now slip the locking collar, with the set screw on it, onto the body. The collar should have the stepped spring seat towards the spring. Slide on the spring. Make sure here that the shaft is out all the way and the nylon spacer is against the plastic ball cup. Now collapse the spring with your fingers and slide the notched plastic spring retainer onto the shaft. Collapse the shock a few times and make sure it's free and smooth.

☐ **Fig. 63**— Now we need to adjust the tension on the spring to get the correct ride height on the car. Move the collar so there is a .200" gap between the collar and the hex. Tighten the set screw carefully. It'll take only a little tension here. If you overtighten the set screw, you'll collapse the shock body and the shock won't work properly.

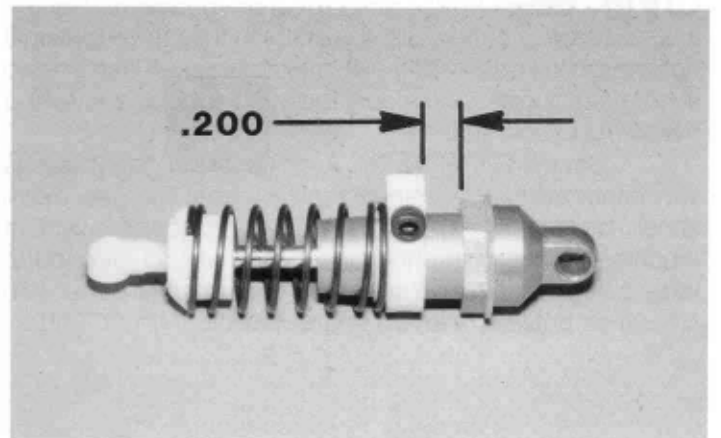

Fig. 63

☐ **Figs. 64 & 65**—Remember when you removed the shock bushing from the shock/ antenna mount in Fig. 22? Now we need that bushing, and it needs to be put into the hole in the shock cap.

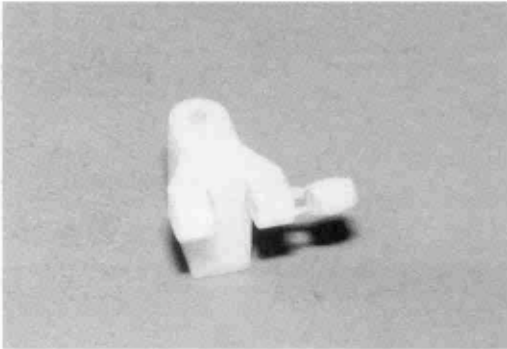

Fig. 64

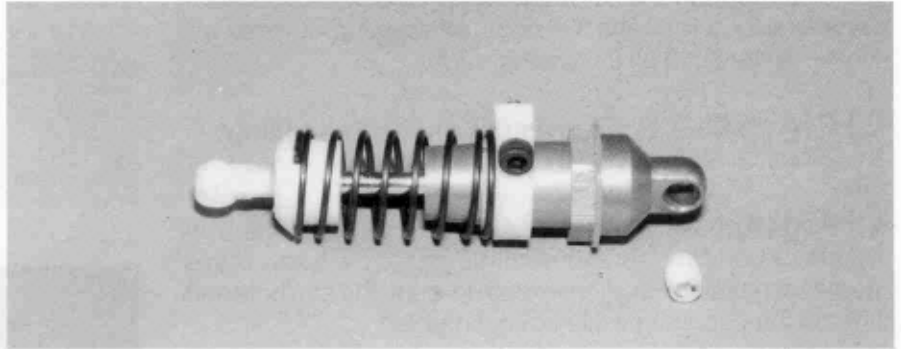

Fig. 65

☐ **Fig. 66**— Making sure the little bushing is in the shock cap, slip the shock in the shock mount at the arrow and install the long allen screw. Do not overtighten.

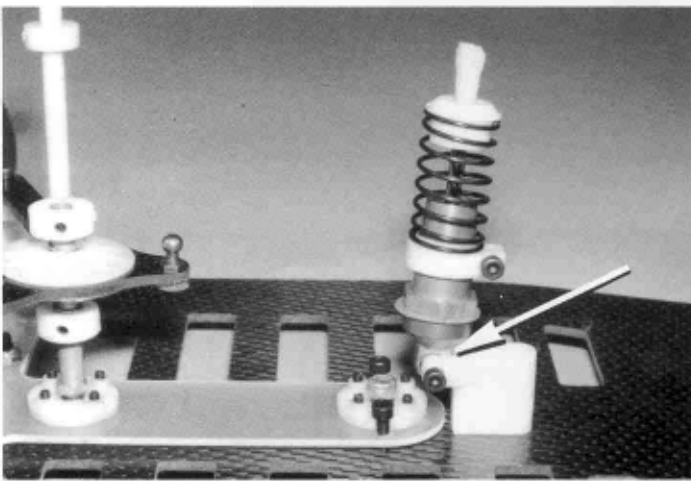

Fig. 66

☐ **Fig. 67**— Now pop the plastic ball cup onto the steel ball at the arrow. A pliers might help here.

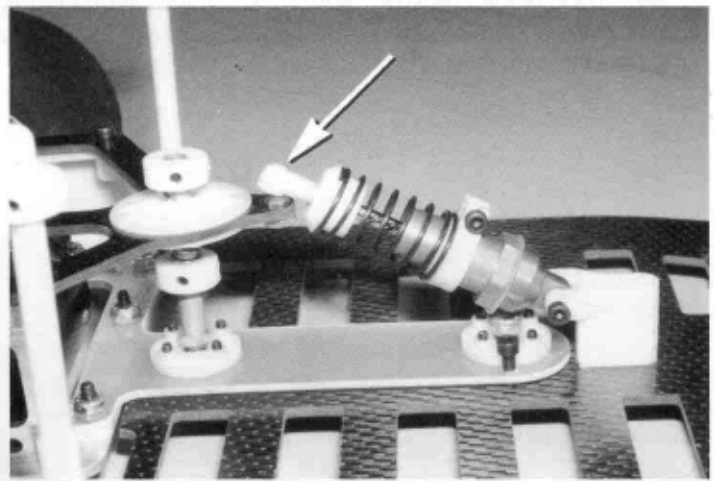

Fig. 67

☐ **Fig. 68**— Put the pinion gear on your motor. Tighten the set screw securely. Slip the motor in the car by pulling it up through the bottom of the aluminum bracket. Use the two short motor screws and mount the motor loosely above and below the pinion gear.

Set the GEAR MESH. A correctly set gear mesh is very important to a car's speed and run time. The gear mesh should be set so the gears are as close as possible without touching. You should check the gear mesh all around the large plastic spur gear. You want to end up with a paper-thin clearance between the two gears. THIS IS IMPORTANT.

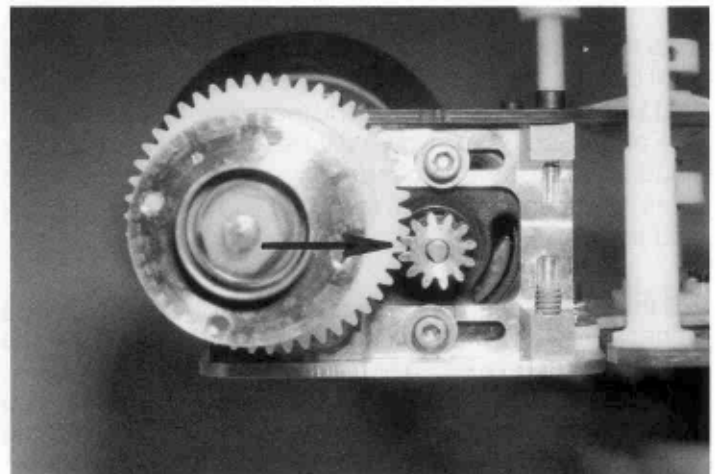

Fig. 68

ELECTRICAL

□ **Fig. 69**— **RADIOS.** There are a number of very good radios on the market now, including Futaba, Airtronics, and others. If you're a serious racer, we recommend that you do not merely get the cheapest radio possible; you'll end up with interference problems at races. Instead, invest in a better grade radio. As for crystals, the 27 band has the best performance; unfortunately, there are only six frequencies available. The 75 band is becoming popular because there are so many frequencies available.

Now refer to Fig. 69. Take your steering servo from Bag #9 and slip the servo saver on it as shown. Now, turn the servo saver all the way to the left with your fingers and then all the way to the right to the stops. You want to mount the servo saver so that it's right in the middle of the stops, as shown. Then screw in the servo shaft screw.

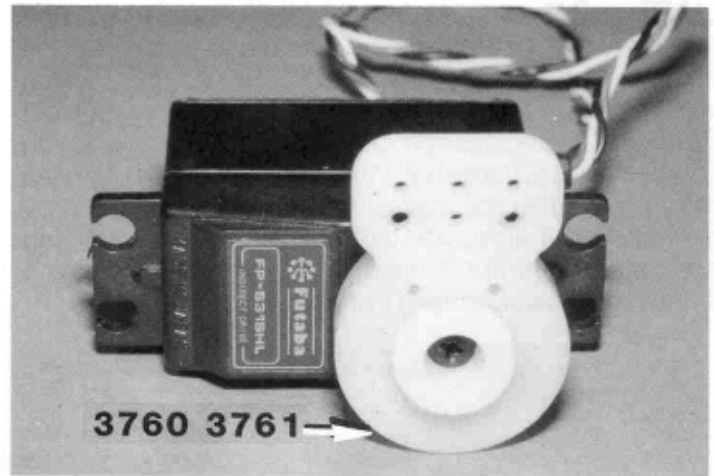

Fig. 69

□ **Figs. 70 & 71**— As you can see in Fig. 70, install the servo so the servo saver is in the center of the car (from left to right), and so the servo saver's rear edge is .100" forward of the chassis cutout. Put it there, make sure everything's okay, and then take the roll of double-sided sticky tape and attach the servo to the chassis with the tape.

Now we can assemble the #3732 piano wire tie rods from Bag #10. Slip one of the "S" bends into each of the steering arms and the other two rod ends into the servo saver. Slip a locking collar around each tie rod. Center the servo saver and center the wheels. No toe-in or toe-out should be necessary.

Tighten the set screws on the two locking collars. Now for the important part: **WE NEED A SMALL AMOUNT OF PLAY IN THE TIE RODS.** Check if each tie rod will rotate a small amount in the steering arms. If they do not, then you'll have to remove the tie rods and burr or lightly countersink the steering arms and servo saver holes with an exacto knife or drill. Re-install the tie rods. Keep trying this until you get a small rotational play in them. Take time to get this right, for if the tie rods are too tight, the front suspension cannot work properly and the car will wander on the track.

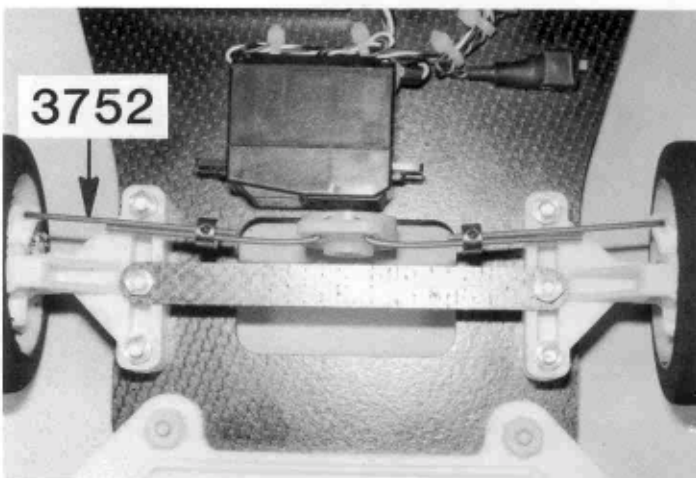

Fig. 70

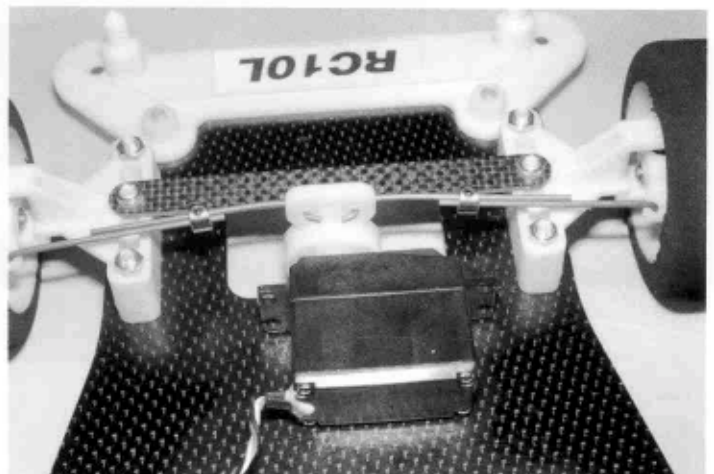

Fig. 71

Fig. 72— RECEIVER. Position your receiver in the location where the Futaba receiver is shown. Attach it to the chassis with the double-sided sticky tape. Feed the antenna wire up through the bottom of the shock/antenna mount and then feed the antenna wire through the antenna tubing so about two inches hangs out. Push the tubing into the antenna mount. Take the excess antenna wire and fold it up neatly and tie-wrap it alongside the receiver. Plug the steering servo wire into the appropriate slot in the receiver according to the radio manufacturer's instructions.

SPEED CONTROL. Fig. 72 shows the location for mounting the Novak #NESC-T1X Speed Control. The Novak speed control is one of the best available (however, there are also many other good, reliable speed controls on the market now). Attach the speed control to the chassis with double-sided sticky tape. Plug the speed control's radio wire into the receiver's throttle control slot according to the radio manufacturer's directions. Next, use the double-sided sticky tape to attach the switch—which should be "off"—to the chassis, where shown. Bundle and tie-wrap all excess wire.

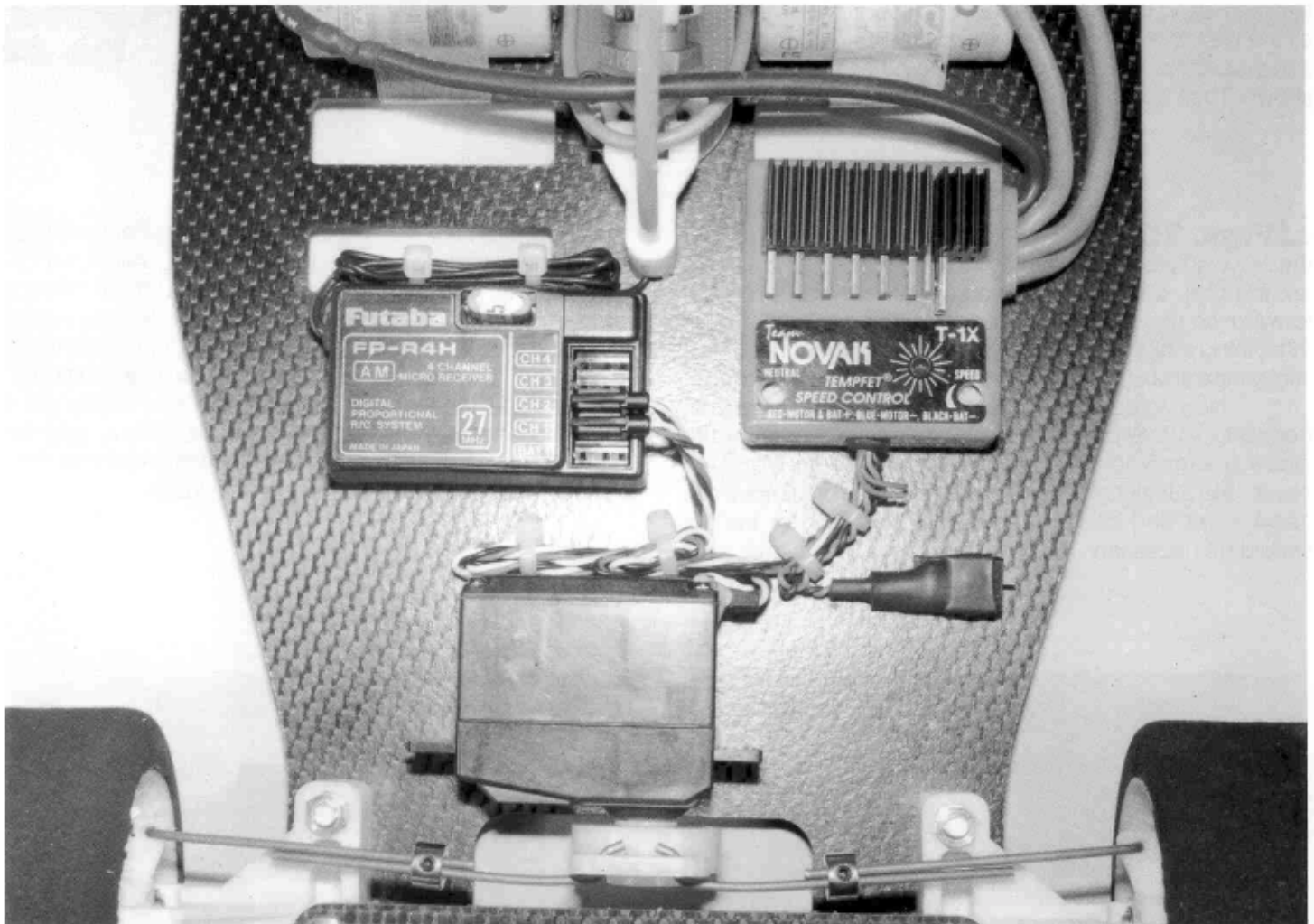

Fig. 72

□ Figs. 73 & 74— BATTERIES.

Associated sells standard Sanyo single cell batteries and Reedy matched 6- or 7-cell battery packs in three different grades. The Reedy batteries have been used to win four IFMAR World Championships. There are none better.

Assemble your 6-cell pack in the position shown. Always use rosin core solder. NEVER use acid core solder on your batteries or on any other electrical connection.

For your convenience, we have numbered our cells 1 through 6 in the photos. Start with cells #1 and #2. Solder a piece of wire or ground strap between the positive ("+") end of the #1 cell and the negative ("-") end of the #2 cell.

Now solder all the rest of the cells together in the exact way as shown in Figs. 73 and 74. Do not solder the long wire yet.

Now set the cells in the car as shown in Fig. 77 and cut a piece of hookup wire, like our #3737, to 5 1/2" long. Check the photo to see where the wire must be attached, take the cells back out of the car, and solder the wire to the #1 and #6 cells.

Now check all your connections. All connections should be "+" to "-" connections. If you have a "+" to "+" or "-" to "-" connection, you've connected your batteries wrong. Check the photos again and correct your connections.

Racer's Tip: You can glue your cells together with silicone cement, making them easier to handle.

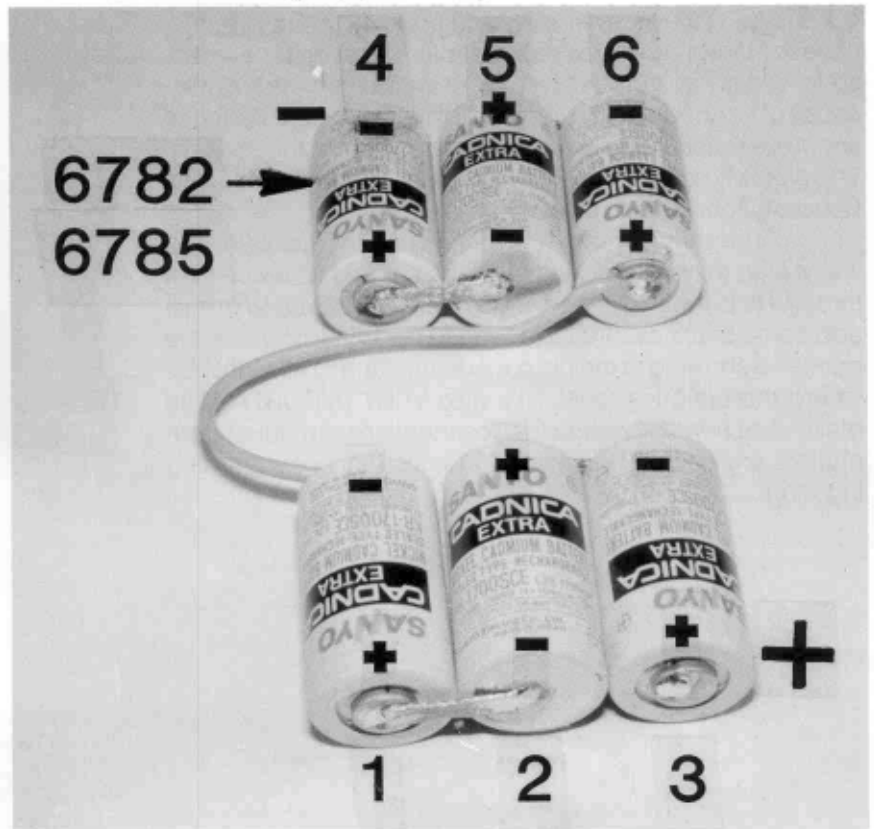

Fig. 73

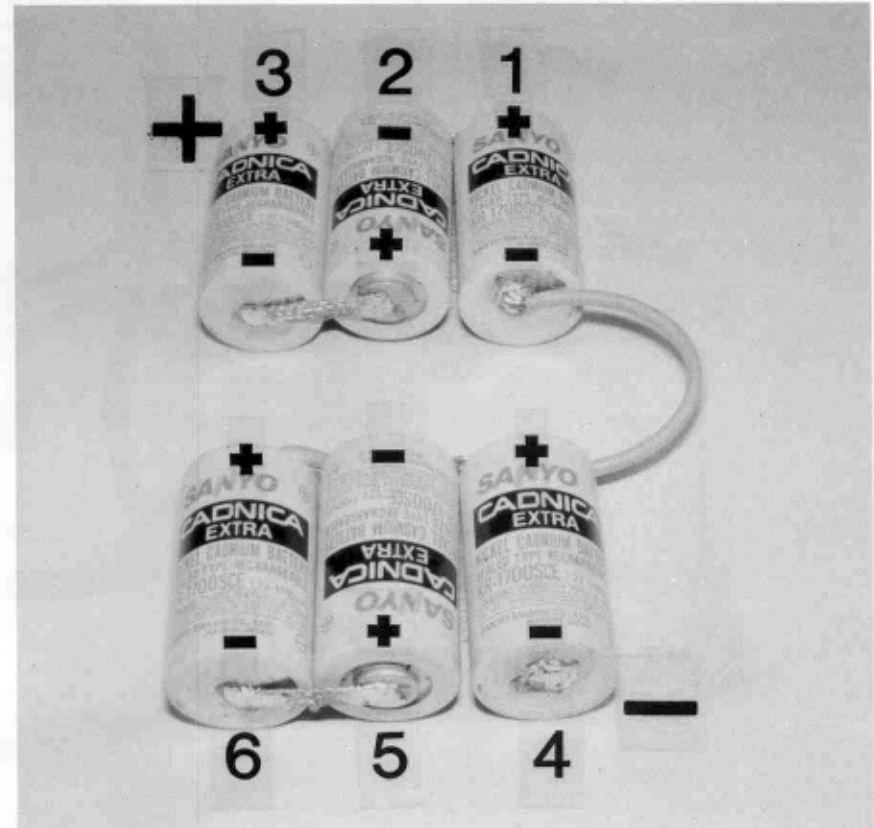

Fig. 74

Fig. 76— This step applies only to the graphite chassis. Graphite conducts electricity somewhat like metal, so for electrical purposes, think of graphite as metal. Because of its conductivity we need to make sure our batteries are properly insulated so they won't short out to the chassis. This step will not apply to you if you have a fiberglass chassis because fiberglass is already an insulator.

The shrink wrap on the battery cell is an insulator and we've filed the sharp edges off of the chassis so it won't cut through it, but we still need to go one step further. We must add some black electrician's tape to the chassis where the pointer is showing in the photo. Add the tape to all eight ribs where the batteries touch. It's also VERY IMPORTANT to make sure none of your solder connections can touch the chassis anywhere. [See page 23 for instructions regarding Fig. 75.]



Fig. 76

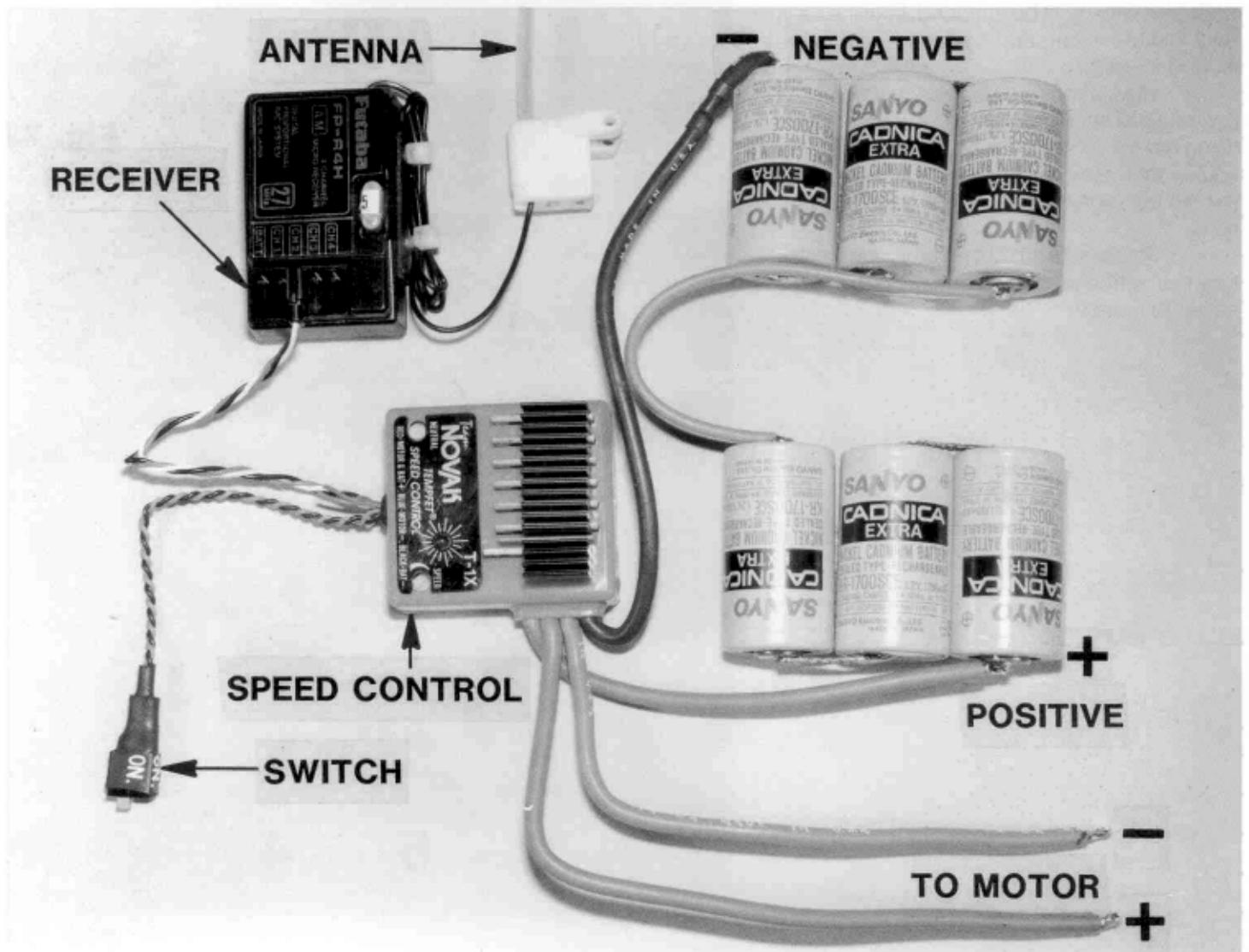

Fig. 75

□ Figs. 75 & 77— Put your battery pack in your car and tape it in place with strapping or filament tape. Now solder your "+" and "-" speed control battery wires to the locations shown in Figs. 75 and 77.

Now solder the "+" and "-" speed control motor wires to the "+" and "-" terminals on the motor. Refer to your speed control instructions for the proper wire hookups.

Different brands of speed controls will be hooked up in different ways, so be sure to follow the speed control manufacturer's recommendations.

Now go back in this manual to Fig. 40 and adjust the two dampner springs with the collars the amount noted, then continue with the tuning section following.

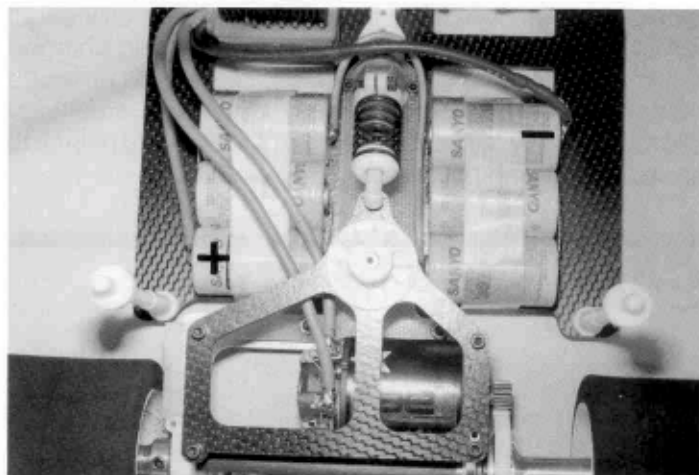

Fig. 77

BATTERY CHARGING

We recommend you use an automatic battery charger like Novak and others make. There are many good brands on the market now. Follow the manufacturer's guidelines.

CHARACTERISTICS OF Ni-Cd BATTERIES

It is important to understand the characteristics of the battery pack in your car, because how you use it will greatly affect both its performance and its life. With proper care your pack will give you top performance for many hundreds of cycles.

The R.O.A.R.- (Radio Operated Auto Racing, Inc.) legal battery is composed of either four or six "sub-C" size cells with a maximum rated capacity of 1.2 amp-hrs. This means that the cells will supply 1.2 amperes for one hour, or 0.6 amperes for two hours, etc. This capacity rating drops to about 1.0 amp-hrs at high drain rates. For instance, at fifteen amperes (a typical average current drain for a 1/10 scale electric car) the cells would discharge in 1/12 of an hour (five minutes). This charge capacity is the same regardless of the number of cells in the pack because the cells are connected in series and the same current passes through each one. In other words, the charge capacity of a four-pack is the same as a six-pack. The total energy storage of a six-pack is higher, of course, because the voltage is higher.

Ni-Cds are very efficient and they give back almost as much charge as you put in, as long as you don't try to put in more charge than they will hold. If you start with a completely dead pack and charge at four amperes for 1/4 hour, you will have put a total of one amp-hr (4 x 1/4) into the cells. More than 95% of the charge would be recovered if the pack were then discharged at the one hour rate.

OVERCHARGE

There is no way to make a Ni-Cd cell accept more charge than it is designed to hold. This means that the charging efficiency begins to drop off as the cell approaches a fully charged condition; and the portion of the charging current not being stored becomes heat and pressure. This means that if charging continues after the cell is fully charged, all of the current is converted to heat and pressure—about 40 watts worth—or the equivalent of the heat produced by a medium-sized soldering iron.

HEAT AND PRESSURE

Excessive heat and excessive pressure—singly or combined—is harmful to the cells; and getting rid of one won't offset the other. For example, cooling the battery with a fan while it's being overcharged will do nothing to stop the pressure build-up.

Excessive pressure momentarily opens a safety vent in the cell and a small amount of electrolyte is lost in the process. One such occurrence is not harmful, but frequent venting will permanently reduce the performance of the cell. Excessively high temperatures can permanently damage the separators. High temperature also has temporary bad effects that will be explained later, under the heading, "High Temperature".

Ni-Cd cells have a built-in process for recombining the accumulated gas (actually oxygen) produced by overcharging, but the process produces heat and takes a lot of time. If you overcharge your battery and it seems to take a long time to cool down, it's because this pressure-reducing reaction is taking place. Once the gas is recombined, the temperature drops.

A hot Ni-Cd pack cannot be fully charged. At 130 degrees F (a temperature uncomfortable to the touch for

more than a few seconds) the cells will accept only about 50% of a full charge. This doesn't mean that a fully charged battery will lose charge if it's heated; it just won't accept a new charge efficiently. For this reason it is always better to allow the battery to cool before charging. A fan is helpful to speed the cooling process.

CHARGERS

All fast-chargers do basically the same thing—supply a charging current of about three to five amperes. They differ in the power source they use (either 12 volts dc or 115 volts ac), and in additional features. Associated Fast Chargers (#3772 and #6772) meet the basic requirements of a good charger, with a timer to protect against accidental overcharge, an ammeter, slow-charge, and a discharge circuit. Some chargers have features like a built-in voltmeter, constant-current, voltage peak detection, or temperature sensing. Naturally, the more features a charger has, the more expensive it becomes.

HOW TO TELL WHEN YOUR CELLS ARE CHARGED

One of the problems with Ni-Cds is their inherent voltage stability; the voltage of a fully charged cell is not much different from one that's about dead. For that reason several indicators, along with some common sense, are needed in order to get the most out of your battery. The following is a list of indicators you should use to detect full charge.

TEMPERATURE METHOD

This works only if you start with a cool battery pack. As the pack charges, frequently check its temperature by feeling the cells directly. As soon as you notice an increase in temperature, stop charging. If the cells become too hot to hold onto, your cells are excessively overcharged. Let them cool.

TIMED CHARGE METHOD

This works only if you have confidence in the timing accuracy of your charger. Many chargers on the market only approximate a constant charging current; they may vary from six amps when you first start charging, all the way down to two amps if the Ni-Cd pack is nearly charged and the voltage of the charging source (automobile battery) is low. If the charging current varies, it becomes difficult to estimate the average current. However, if your charger is reasonably dependable, you can use the following method.

Cycle your pack several times using the "tempera-

ture method" above. After you run the car the last time, let the pack cool. Charge again using the temperature method, but this time keep track of the time required to reach full charge. Once you have established the time, you can use it as a setting for the timer on your charger. To be safe, use a setting about a minute less than what you established. This method allows you to charge without constantly monitoring the battery temperature.

If you charge a battery that is still hot from running, reduce the time about 20%. Then, after the pack has cooled, finish charging with the temperature method.

VOLTAGE METHOD

As mentioned earlier, voltage is a poor indication of a cell's state of charge. The change in voltage from 10% charged to 100% charged is usually less than 0.1 volts per cell. In fact, other factors like temperature, current drain, and "cell memory" have a greater effect on voltage than the state of charge does. However, if current flow and temperature are held constant, it is possible to see the cell voltage gradually climb during the charging process. The absolute value of this voltage isn't of much use—how the voltage changes is an excellent indicator. To use this method, you will need a digital voltmeter or an expanded-scale voltmeter capable of resolving 0.01 volts on the 10 volt range.

Connect the voltmeter across the Ni-Cd pack, preferably right at the cell terminals, or, if that's not possible, across the terminals of the throttle control resistor. Don't try to read the voltage at the output of the charger because you'll end up reading the voltage drop through all the connectors and cables between the charger and the Ni-Cd pack, which can sometimes distort the effect you're looking for. You should start with a Ni-Cd pack that is less than half charged. Connect your charger and begin charging at four amps. If your charger is adjustable, set the current now—don't try to change it later. A constant current charger is preferable here, but if yours gradually drops off during charge, that's still permissible, as long as it doesn't drop below three amps.

Watch the voltage as the pack charges. Notice that the voltage at first climbs rapidly and in the middle of the charging cycle more slowly. This voltage will most likely be in the range of 8 1/2 to 9 volts for a six cell pack. As the pack approaches full charge, the voltage will begin to climb more rapidly; and as it goes into overcharge, the climb will slow down and then stop. This is where you stop charging—at the point where the voltage stops climbing. If you left the charger on, the voltage would begin to fall as the pack went deeply into overcharge and started to heat up. The maximum voltage reached will probably be in the nine to ten volt region; the actual value is unimportant.

Do not try to use a conventional voltmeter. Even a good quality VOM with a large, taunt-band, mirrored-scale meter movement is not adequate; by the time you could see that the voltage had stopped rising, it would be too late.

SLOW CHARGE METHOD

Slow or "overnight" charging is a method you are not likely to use often. However, it is a good way to bring the pack to absolutely full charge.

The charging current must be between 0.05 and 0.12 amperes. If less current, the pack will never reach full charge; any more and the pack will overheat. The time required to reach full charge ranges from 15 to 40 hours, depending on the current used. The charger can be left on for a much longer time without harming the cells, however, the output voltage of the pack will be temporarily lowered by an extremely long overcharge. The voltage returns to normal after a discharge-charge cycle.

GETTING MAXIMUM VOLTAGE TO THE MOTOR

The tips that follow are really for the benefit of serious racers, since these tips deal with factors that influence the voltage and available power of a Ni-Cd pack. We're talking about a difference of maybe 15% at the most, so if you're just out having fun, don't worry about it. Instead, skip ahead to the Radio section.

The output of a fully charged pack can vary considerably, depending on the temperature and recent activity of the pack. These effects are listed below.

HIGH TEMPERATURE contributes its bad effects by lowering the output voltage under load. Less voltage means less speed. At normal 130 degrees F, the voltage of a six cell pack can be almost a volt less than normal. Since a lot of heat is produced in the pack while the car is running, it's important to allow air to circulate around the batteries to keep them cool. Therefore, before the start of a race, keep your car out of the sun and off the hot asphalt.

MEMORY can also affect the output voltage. The first memory effect is caused by overcharging. The cells "remember" that they were overcharged and put out less voltage near the end of the discharge cycle. This is particularly noticeable if the pack is slow-charged for too long a time.

The second memory effect is caused by repeatedly not using up all of the battery's stored charge before recharging. The cells "remember" that they weren't fully used and let the voltage drop off to about one volt at the point where discharge usually stops. An example would be where you run a series of five minute heats, recharging between each heat, and then try to run an eight minute heat. The battery voltage will be low for the last three minutes of the

race. The cure is to fully discharge the pack before recharging. "Full discharge" means the point where the first cell goes dead. Never discharge beyond that point.

The third memory effect is the "topping-up" effect of recent charging. The cells remember that they were recently charged and will produce a little more voltage early in the discharge cycle. Racers take advantage of this by putting the last minute or two of charge into their pack just before the race starts.

GETTING MAXIMUM PERFORMANCE

FULL DISCHARGE. Ni-Cd packs perform best if they are completely discharged before they are charged. If you are involved in racing, you will have to do this if you expect to win any races! Associated Chargers have a discharge function. Various clip-on discharge resistors (about 30 ohms, 10 watts) are available at hobby stores. Discharge for at least an hour (preferably overnight with a clip-on resistor) before charging.

TOPPING-UP can give you a little extra voltage at the beginning of a race, as long as you don't overdo it. Put the last minute or two of charge into your pack just before the race starts.

YOUR RADIO

Now that you know all about batteries, go ahead and charge your batteries. After the car batteries are charged and the transmitter batteries are charged, we'll set the steering servo and speed control.

Now turn the transmitter on. Hold the rear tires off the ground and turn the receiver switch on. The motor may start to run, which means your speed control must be set. Whether the motor runs or not, **THE TRANSMITTER MUST BE SET NOW.** Set it according to the manufacturer's recommendations. This is a very critical adjustment and will determine the car's top speed and battery life. Set it so there are no brakes. The car will have enough steering, so brakes are not used.

After the speed control is set, turn the receiver switch on.

Push the Kimbrough servo saver back on and align it so that the wheels are pointing perfectly straight forward. Install the servo saver screw.

Turn the steering wheel to the right. With your car pointing away from you, the wheels should turn (steer) to the right. If they turn to the left, move the steering servo reversing switch on the transmitter.

SETTING THE TWEAK

What is tweak? The left front wheel should be pushing down on the ground with the exact same amount of weight as the right front wheel.

Likewise, the left rear wheel should be pushing down on the ground with the exact same amount of weight as the right rear wheel.

If this isn't happening, the the car is TWEAKED (or twisted). This will cause the car to spin out easily under acceleration; it will also cause it to have oversteer in one direction and understeer in the other direction.

TO CHECK THE TWEAK, take a ruler and measure from the outside of the left hand rear tire to the outside of the right hand rear tire. This should be almost $9\frac{3}{16}$ ". Now take exactly half that amount which will be almost $4\frac{19}{32}$ " and mark this EXACT centerline of the car on the lower bracket #8202 (shown in Fig. 32). Just scratch a mark on the bracket with an Exacto knife.

Now set the car on a very flat and level table. Take the Exacto knife blade and put the edge of the blade underneath the bracket EXACTLY where your mark is and very slowly lift up on the blade. BOTH rear tires should come up off the table at EXACTLY the same instant. If one tire lifts off the table the slightest amount before the other tire, the car is tweaked.

TO CORRECT THE TWEAK, refer back to Fig. 19 and loosen one screw $\frac{1}{8}$ of a turn (arrow points to a screwdriver adjusting the tweak). Recheck the tweak. Keep doing this procedure of lifting and loosening until the tweak is flat. IMPORTANT— Always loosen one of the two screws first and then tighten the second screw the exact same amount.

TOE-IN—Normally, we do not use toe-in or toe-out. But if you run on a very slippery track, you might want to try some toe-in. This is done by adjusting the #4126 tie rods (Fig. 70) so they're a little longer.

CASTER—You will probably not have to use any caster.

YOUR MOTOR

Associated recommends the Reedy Modified motors. These motors have won four IFMAR World Championships. No other motors have come close to this record. Check your RC10L catalog for the various types of motors.

If you treat it properly, your motor will not only last much longer, but will run faster for a longer time too. So never let the brushes wear down too low. If they show signs of wearing, install new brushes. And never deliberately stall your motor. If your car is stuck in the wall, don't punch the throttle; you'll end up burning out your motor and speed control.

Reedy also makes a motor cleaner and motor lubricant—two excellent products vital for the care of your motor.

TRANSMITTER DUAL RATE

You should always turn the front wheels the LEAST AMOUNT NECESSARY to get around the track fast, not the most amount. So use the dual rate switch on your transmitter to give you the exact amount of steering you need and NO MORE.

YOUR BODY

MOUNT your body on the car while it is still clear so you can see through it to easily mark the body mount holes and antenna holes. The bottom of the body should be even with the chassis.

PAINT your body by masking off the inside of your body with regular automotive masking tape according to your paint scheme. Follow the tips that come with your Associated body you purchase separately. The best body paint to use is Pactra, available in all hobby stores.

YOUR WING

You probably won't need a wing if you run on carpet, but if you run on asphalt, try the car with and without a wing to see which works best on your track.

RC10L PARTS IDENTIFIER DIAGRAM

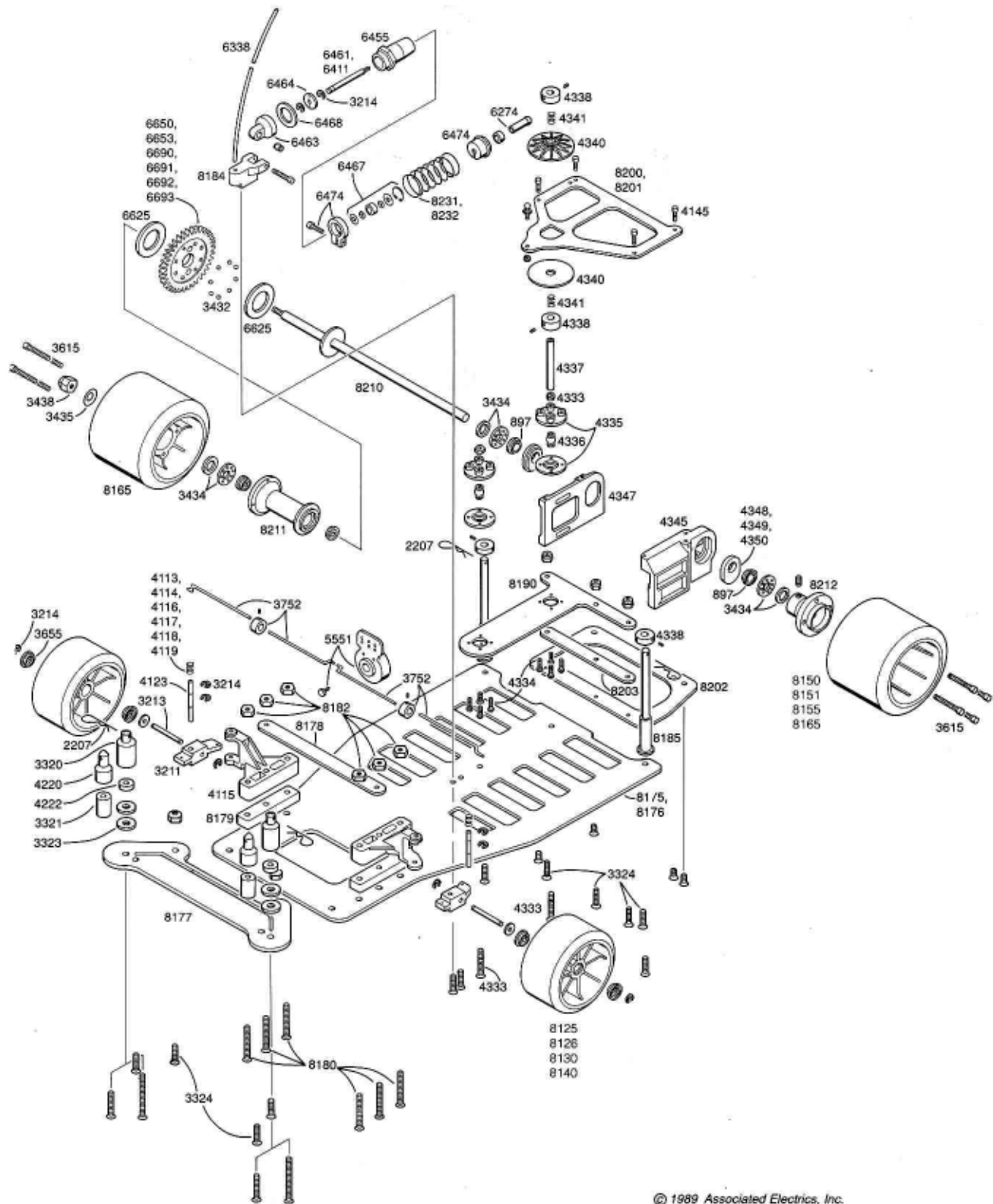

© 1989 Associated Electrics, Inc.

- NUMBERS REFER TO CATALOG ITEM NUMBERS FOR THE RC10L.
- CAUTION: INCOMPLETE ASSEMBLY OF #8001 RC10L GRAPHITE KIT DEPICTED--- DO NOT ASSEMBLE YOUR KIT USING THIS DRAWING.
- DUE TO ASSOCIATED'S ON-GOING R & D COMMITMENT TO MAXIMIZE CAR PERFORMANCE, PARTS ARE SUBJECT TO MODIFICATION, REPLACEMENT OR ELIMINATION WITHOUT NOTICE. THEREFORE, PARTS SHOWN MAY NOT REFLECT ACTUAL APPEARANCE OR MAY NO LONGER BE AVAILABLE.
- CHECK CATALOG LISTINGS FOR CURRENT PART STATUS.